

11b) Classical Component Systems – CORBA

Prof. Dr. Uwe Aßmann

Florian Heidenreich

Technische Universität Dresden

Institut für Software- und

Multimediatechnik

<http://st.inf.tu-dresden.de>

11-0.2, Mai 4, 2011

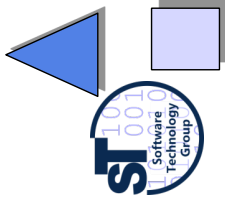

1. Basic mechanisms for modularity, exchangeability, adaptation, transparency
2. Composition technique (connections)
 1. Dynamic Call
 2. Traded Call
3. Evaluation according to our criteria list
4. CORBA Services
5. CORBA Facilities

CBSE, © Prof. Uwe Aßmann

1

Obligatory Reading

- ▶ ISC, 3.1-3.3
- ▶ Szyperski 2nd edition, Chap 13
- ▶ <http://java.sun.com/javase/6/docs/technotes/guides/idl/>
- ▶ <http://java.sun.com/developer/technicalArticles/releases/corba/>



Literature

- ▶ R. Orfali, D. Harkey: Client/Server programming with Java and Corba. Wiley&Sons. easy to read.
- ▶ R. Orfali, D. Harkey, J. Edwards: Instant Corba. Addison-Wesley.
- ▶ CORBA. Communications of the ACM, Oct. 1998. All articles. Overview on CORBA 3.0.
- ▶ CORBA 3.1 specification: <http://www.omg.org/spec/CORBA/3.1/>
- ▶ Jens-Peter Redlich, CORBA 2.0 / Praktische Einführung für C++ und Java. Verlag: Addison-Wesley, 1996. ISBN: 3-8273-1060-1



The CORBA Vision

One Repository to register them all,
One Repository to find them,
One Repository to start them all,
and with IIOB bind them
In the land of CORBA where the objects lie.

(J. Siegel, after J.J.R. Tolkien)



11b.1 Basic Mechanisms

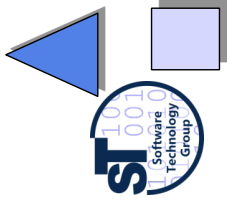

CBSE, © Prof. Uwe Alsmann

5

CORBA



- ▶ Common Object Request Broker Architecture®
- ▶ Founding year of the OMG (object management group) 1989
- ▶ Goal: plug-and-play components everywhere
- ▶ Corba 1.1 1991 (IDL, ORB, BOA)
- ▶ ODMG-93 (Standard for OO-databases)
- ▶ Corba 2.0 1995, later 2.2 and 2.4
- ▶ Corba 3.0 1999



Ingredients of CORBA

▶ Component Model

- Components are classes and objects, i.e., similar to object-oriented software
 - In CORBA 3.0, the CCM has additionally been introduced
- Components have more component secrets
 - Language interoperability by uniform interface description
 - Location transparency
 - Name transparency
 - Transparent network protocols
- Standardization
 - CORBA Services
 - CORBA Facilities

■ Horizontal vs. vertical

▶ Composition Techniques

- Adaptation by stubs and skeletons
- CORBA MOF for metamodeling

OMA (Object Management Architecture)

▶ A software bus, based on the Mediator (Broker) design pattern

- Coupled by decorator-connectors

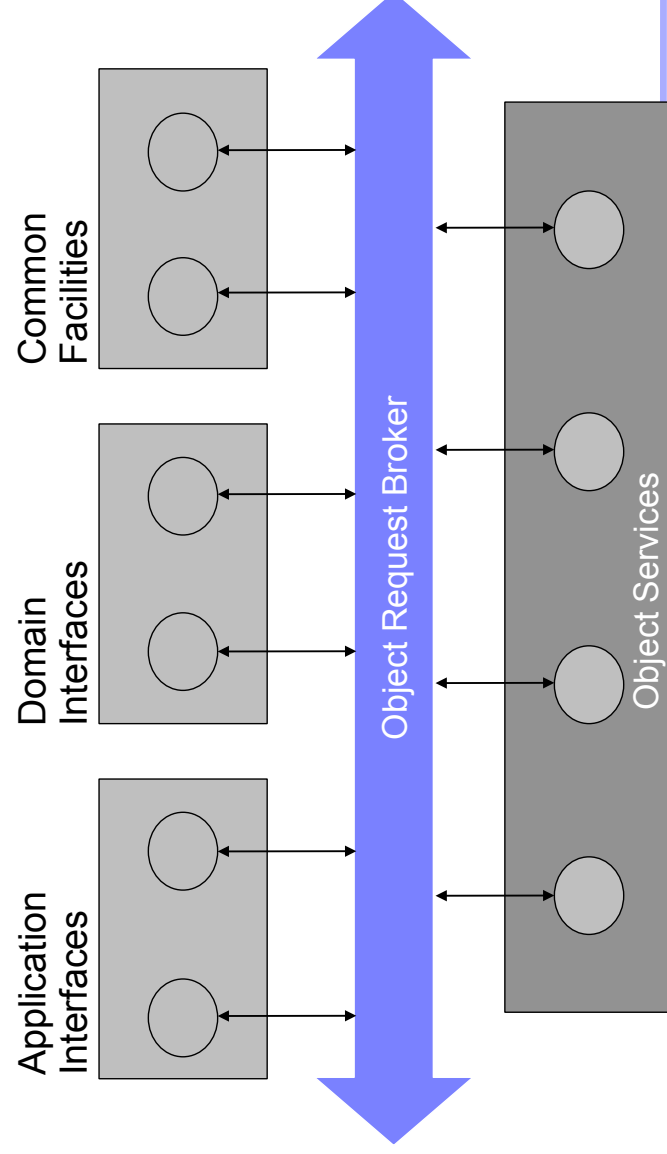

Corba's Hydrocephalus

- ▶ Corba is large
 - Object Request Broker – 2000 pages of specification
 - Object Services – 300 pages
 - Common Facilities – 150 pages
- ▶ Technical reasons
 - Clean detailed solution
 - Sometimes overkill
- ▶ Sociologic reasons
 - OMG is large (over 800 partners) and heterogenic
 - Standard covers a wide rage
- ▶ Linguistic reasons
 - Tons of unintuitive 3-capitals-names (OMG, ORB, IDL, ...)

The Top Class CORBA::Object

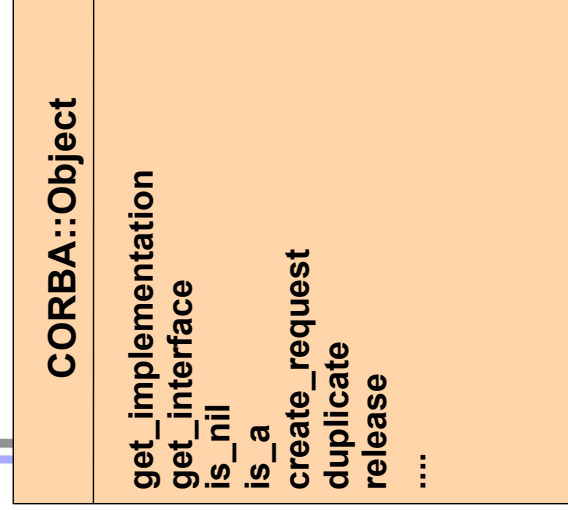

- ▶ The class **CORBA::Object** defines a component model
 - The class must be inherited to all objects in the application
- ▶ CORBA supports reflection and introspection:
 - `get_interface` delivers a reference to the entry in the interface repository
 - `get_implementation` a reference to the implementation
- ▶ Reflection works by the interface repository (list_initial_references from the **CORBA::ORB** interface).

Problem: Multiple Inheritance of CORBA Object

- ▶ CORBA::Object includes code into a class
- ▶ Many languages only offer only single inheritance
 - Application super class must be a delegatee
 - Could be solved by mixin inheritance (mixin layers)

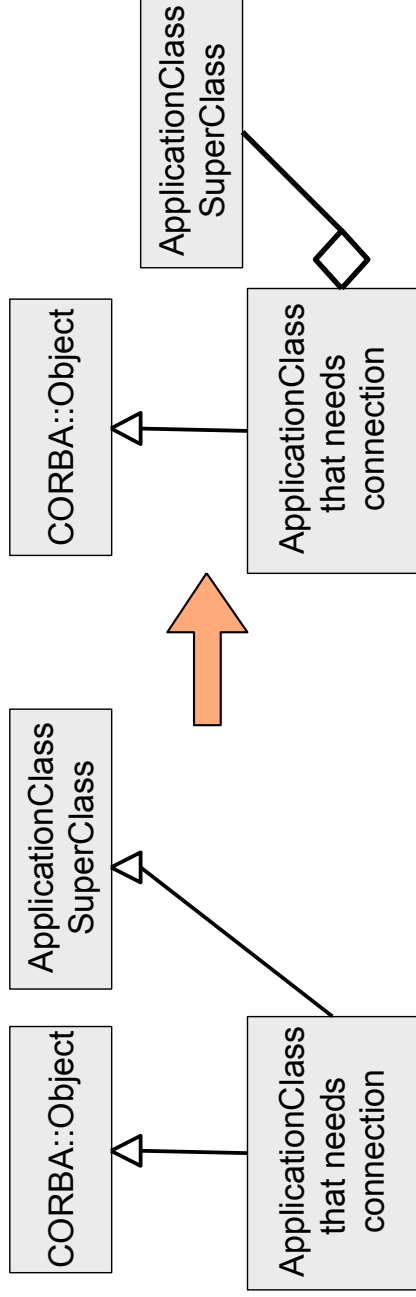

11b.2 Composition Technique of CORBA (Basic CORBA Connections)

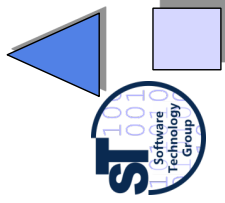



Basic Connections in CORBA

- ▶ CORBA composes components with connections
 - Static method call with static stubs and skeletons
 - Local or remote
 - Polymorphic call
 - Local or remote
 - Event transmission
 - Callback (simplified Observer pattern)
 - Dynamic invocation (DII, request broking)
 - Searching services dynamically in the web (location transparency of a service)
 - Trading
 - Find services in a yellow pages service, based on properties



Static CORBA Call

- ▶ Advantage: methods of the participants are statically known
 - Indirect call by stub and skeletons, without involvement of an ORB
 - Supports distribution (exchange of local call in one address space to remote call is very easy)
 - Inherit from CORBA class
 - Write an IDL spec
 - No search for service objects, rather fast
 - Better type check, since the compiler knows the involved types
- ▶ The call goes through the server object adapter (server decorator)
 - Basic (server) object adapter (BOA)
 - Portable (server) object adapter (POA)
 - This hides the whether the server is transient or persistent



Basic Object Adapter BOA

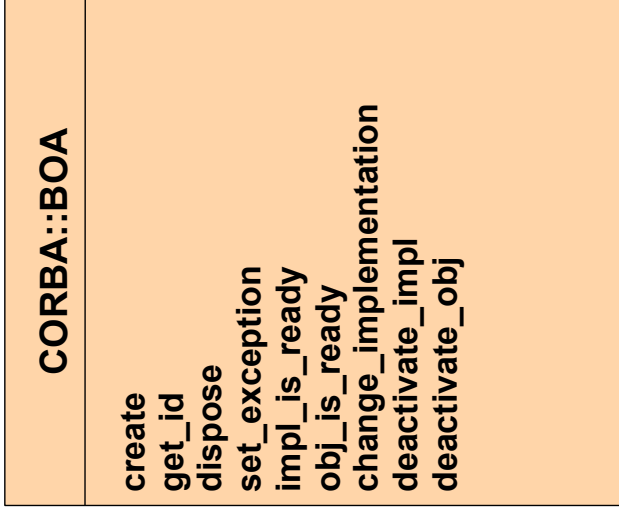

- ▶ The BOA hides
 - Life time of the server object (activation: start, stop)
 - Persistency
- ▶ The BOA is implemented in every ORB, for minimal service provision
- ▶ The BOA maintains an implementation repository (component registry)
- ▶ It supports non-object-oriented code
- ▶ The BOA is a real adapter (no decorator)



Server Site

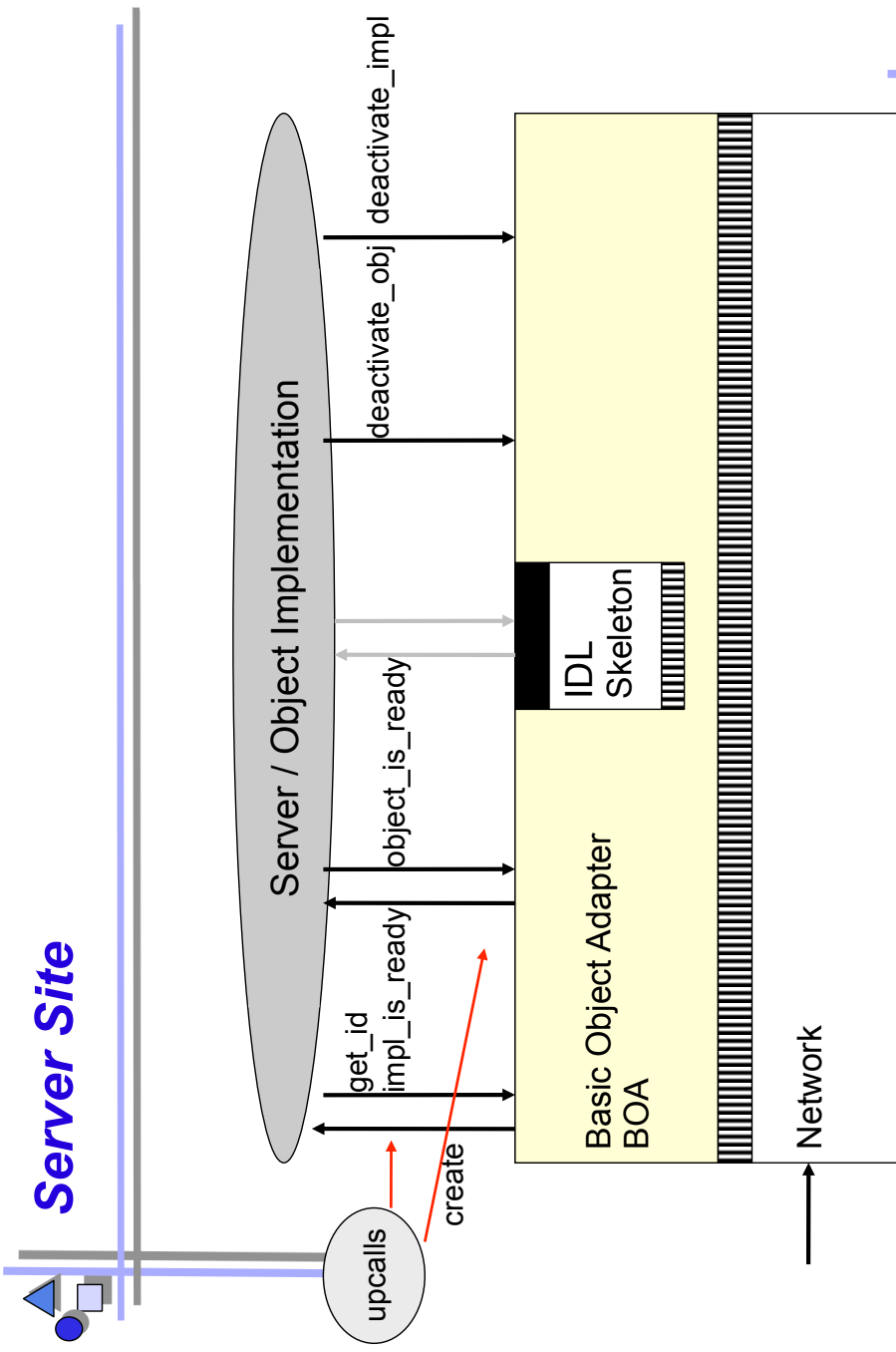

Object Activation on the Server through a BOA

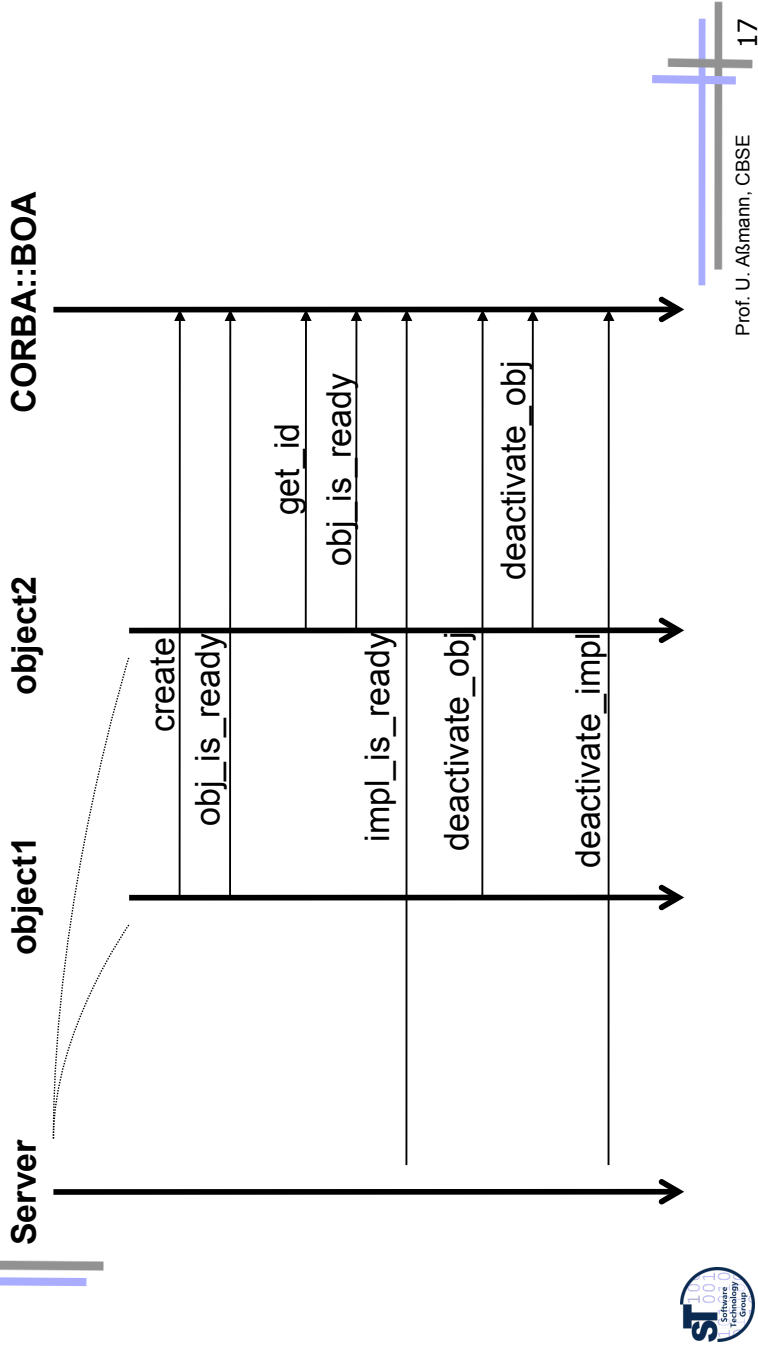

Portable Object Adapter POA

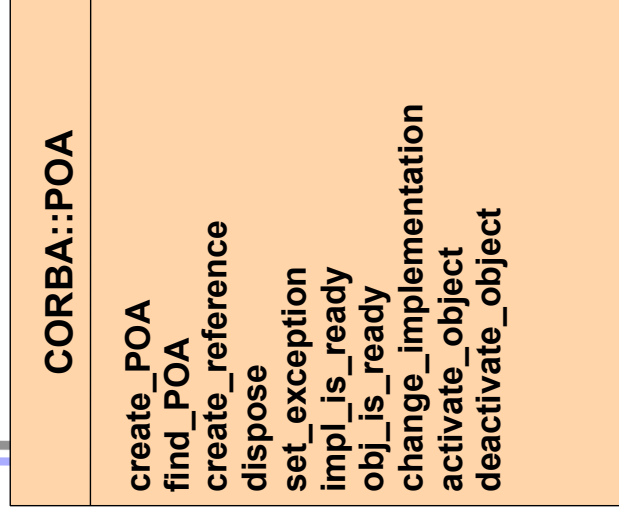

- ▶ The POA is an evolution of the BOA in CORBA 3.0
 - One per server, serving many objects
 - Nested POAs possible, with nested name spaces
- ▶ User policies for object management
 - User-written instance managers for management of object instances

Object Adapters Support Different Server Life-Time Models

Common server process (shared server)

- Several objects reside in one process on the server; the BOA initializes them as threads with common address space (common apartment)
 - deactivate_impl, impl_is_ready, obj_is_ready are mapped directly to thread functions

Separate server process (unshared server)

- For every object an own process

Server-per-request (session server)

- Every request generates a new process
- Similar to Session EJB

Persistent server

- Another application stores the objects (e.g., a data base).
- The BOA passes on the queries
- Similar to Entity Bean

Callback Connectors with the Callback Service

The Callback pattern is a simplified Observer pattern

- Registration and notification, but not status update
- Callback function registration
- Register a procedure variable, a closure (procedure variable with arguments), or a reference to an object at the subject, the server
- Callback works for all languages, not only object-oriented ones

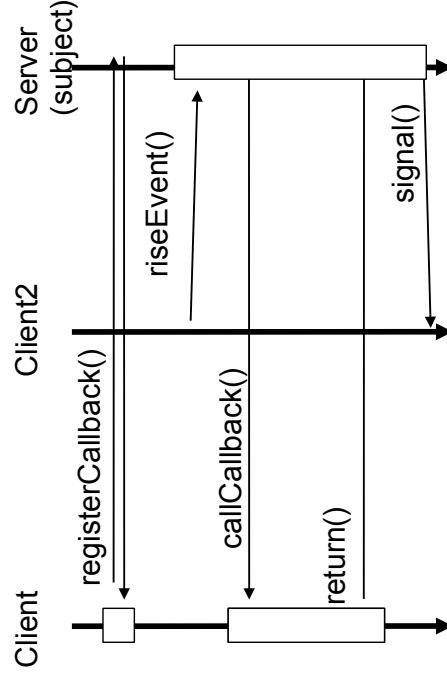



Event Connections

- ▶ Most flexible way of communication (also called messages)
 - Asynchronous communication
 - Works for every CORBA language
- ▶ Receiver models
 - **Unicast:** one receiver
 - **Multicast:** many receivers
 - **Dynamically** varying receivers
- ▶ **Push model:** PushConsumer/PushSupplier: object delivers event with push, event is shipped automatically
- ▶ **Pull model:** PullSupplier/PullConsumer: object waits for event with pull
 - Synchronous or asynchronous
 - Untyped generic events, or typed by IDL
- ▶ **Event channels as intermediate buffers**
 - Channels buffer, filter, and map of pull to push
 - Advantage:
 - Asynchronous Working in the Web (with IIOP and dynamic Call)
 - Attachment of legacy systems interesting for user interfaces, network computing etc.
 - Disadvantage: Very general interface



11b.2.1 Dynamic Call Connector (Request Broking)

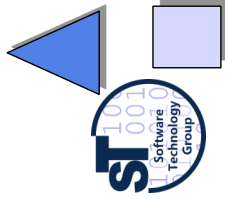



Dynamic Call Connector (Request Broking)

- ▶ CORBA *dynamic call* is a *symbolic call*, i.e., a reflective call with a symbolic name and arguments
 - Without knowing that the service exists
 - Services can be dynamically exchanged, brought into the play a posteriori
 - Without recompilation of clients, nor regeneration of stubs
 - Binding of names to adresses is dynamic
- ▶ Requires descriptions of semantics of service components
 - For identification of services
 - Metadata (descriptive data): catalogues of components (interface repository, implementation repository)
 - Property service (later)
- ▶ and a mediator, that looks for services: the ORB



Object Request Broker (ORB)

- ▶ For a dynamic call, the ORB must be involved
- ▶ The ORB is a *mediator* (design pattern) between client and server
 - ▶ Hides the the environment from clients
 - ▶ Can talk to other ORBs, also on the web

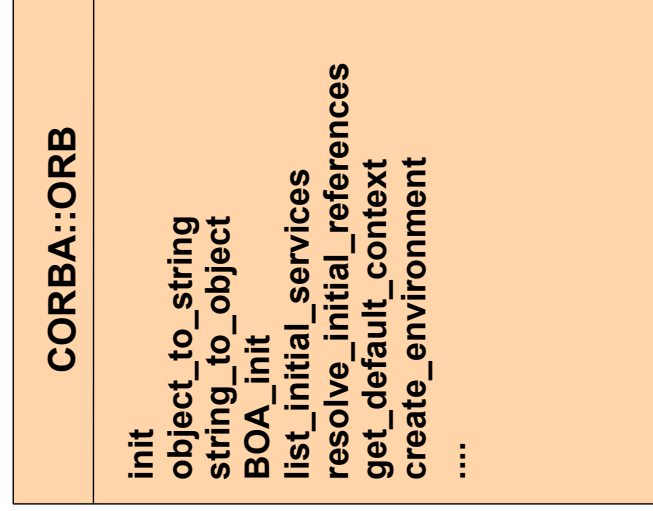

ORB Activation

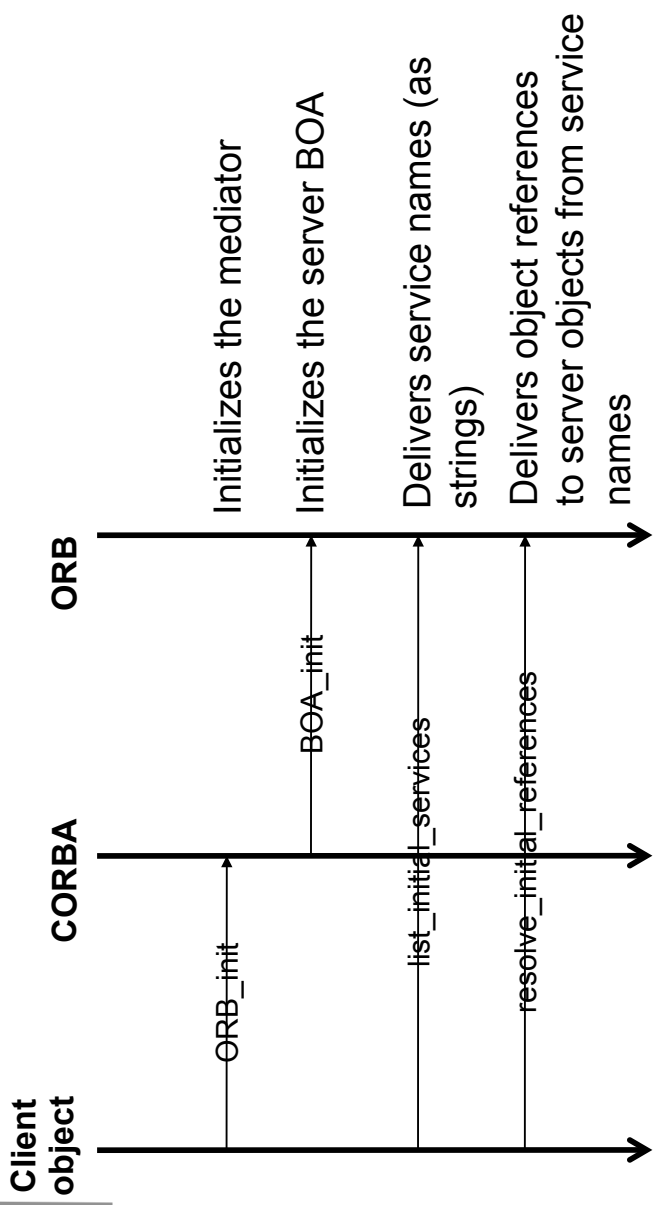

Requesting a Service via the ORB

```
CORBA::ORB
// dynamic call
create_list
create_operation_list
add_item
add_value
invoke
poll_response
send
get_response
delete
....
```

- ▶ Reflective calls
 - Building a call object (Request)
 - Adding arguments
 - Invoking
 - Polling, reading

Protocol of Dynamic Call (DII)

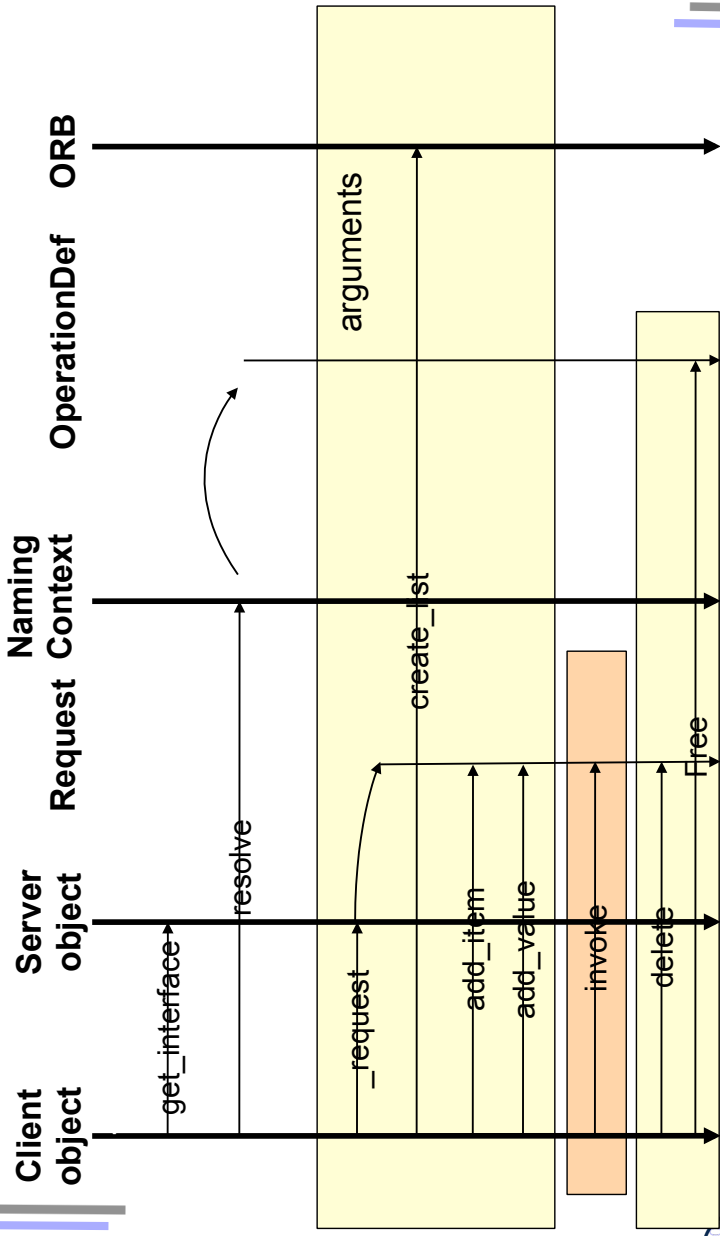

Example Dynamic Call in C++

```

// Wow, a complex protocol!!!

CORBA::ORB_ptr orb;
main(int argc, char* argv[]) {
    orb= CORBA::ORB_init(argc,argv, ORBID);
    // alternative description of service
    CosNaming::NamingContext_ptr naming=
        CosNaming::NamingContext::_narrow(
            ::resolve_initial_references
                ("NameService"));
    CORBA::Object_ptr obj;
    try {
        obj= naming->resolve(mk_name("dii_smp1"));
    } catch (CORBA::Exception) {
        cerr << "not registered" << endl; exit(1); }

    // construct arguments
    CORBA::Any val1; val1 <= (CORBA::Short) 123;
    CORBA::Any val2; val2 <= (CORBA::Short) 0;
    CORBA::Any val3; val3 <= (CORBA::Short) 456;

    // Make request (short form)
    CORBA::Request_ptr rq= obj->_request("op");
    // Create argument list
    rq->arguments() = orb->create_list();
    rq->arguments()->add_value("arg1", val1, CORBA::ARG_IN);
    rq->arguments()->add_value("arg2", val2, CORBA::ARG_OUT);
    rq->arguments()->add_value("arg3", val3, CORBA::ARG_INOUT);
    // Start request (synchronously)
    cout << "start request" << endl;

    rq->invoke();
    // analyze result
    CORBA::Short rslt;
    if (*(rq->result()->value()) >= rslt) {
        // Analyze the out/inout-parameters (arg1 has index 0)
        CORBA::Short arg2, arg3;
        *(rq->arguments()->item(1)->value()) >= _arg2;
        *(rq->arguments()->item(2)->value()) >= _arg3;
        cout << "arg2=" << _arg2 << " arg3=" << _arg3
            << " return=" << rslt << endl; }
        cout << "result has unexpected type" << endl; }
}
    
```

DII Invocation in Java (1)

```
// Client.java
// Building Distributed Object Applications with CORBA
// Infowave (Thailand) Co., Ltd.
// http://www.waveman.com
// Jan 1998
public class Client {
    public static void main(String[] args) {
        if (args.length != 2) {
            System.out.println("Usage: vbj Client <carrier-name> <aircraft-name>");
            return;
        }
        String carrierName = args[0];
        String aircraftName = args[1];
        org.omg.CORBA.Object carrier = null;
        org.omg.CORBA.Object aircraft = null;
        org.omg.CORBA.ORB orb = null;
        try {
            orb = org.omg.CORBA.ORB.init(args, null);
        }
        catch (org.omg.CORBA.SystemException se) {
            System.err.println("ORB init failure " + se);
            System.exit(1);
        }
    }
}
```



DII Invocation in Java (2)

```
{ // scope
    try {
        carrier = orb.bind("IDL:Ship/AircraftCarrier:1.0",
            carrierName, null, null);
    } catch (org.omg.CORBA.SystemException se) {
        System.err.println("ORB init failure " + se);
        System.exit(1);
    }
    org.omg.CORBA.Request request = carrier._request("launch");
    request.add_in_arg().insert_string(aircraftName);
    request.set_return_type(orb.get_priwithive_tc(
        org.omg.CORBA.TCKind.tk_objref));
    request.invoke();
    aircraft = request.result().value().extract_Object();
}
{ // scope
    org.omg.CORBA.Request request = aircraft._request("codeNumber");
    request.set_return_type(orb.get_priwithive_tc(
        org.omg.CORBA.TCKind.tk_string));
    request.invoke();
    String designation = request.result().value().extract_string();
    System.out.println("Aircraft " + designation + " is coming your way");
}
}
```



Server Implementation

```
// Building Distributed Object Applications with CORBA
// Infowave (Thailand) Co., Ltd.
// http://www.waveman.com
// Jan 1998
public class Server {
    public static void main(String[] args) {
        org.omg.CORBA.ORB orb = null;
        try {
            orb = org.omg.CORBA.ORB.init(args, null);
        } catch (org.omg.CORBA.systemsexception se) {
            System.err.println("ORB init failure " + se);
            System.exit(1);
        }

        org.omg.CORBA.BOA boa = null;
        try {
            boa = orb.BOA_init();
        } catch (org.omg.CORBA.systemsexception se) {
            System.err.println("BOA init failure " + se);
            System.exit(1);
        }

        Ship.AircraftCarrier carrier =
            new AircraftCarrierImpl("Nimitz");

        try {
            boa.impl_is_ready();
        } catch (org.omg.CORBA.systemsexception se) {
            System.err.println(
                "Object Ready failure " + se);
            System.exit(1);
        }

        System.out.println(
            carrier + " ready for launch !!!");
    }
}
```

Prof. U. Alsmann, CBSE

31

Example: Time Server in Java

- ▶ On one machine; 2 address spaces (processes)
 - ▶ Call provides current time
 - ▶ Contains
 - IDL
 - Server
 - Starts ORB
 - Initializes Service
 - Gives IOR to the output
 - Client
 - Takes IOR
 - Calls service
- ```
// TestTimeServer.idl
module TestTimeServer{
 interface ObjTimeServer{
 string getTime();
 };
};
```

Prof. U. Alsmann, CBSE

32



## Service Component

```
// TestTimeServerImpl.java - Server Skeleton
import CORBA.*;
class ObjTestTimeServerImpl extends
 TestTimeServer.ObjTimeServer_Skeleton { // generated from IDL
 // Variables
 // Constructor
 // Method (Service) Implementation
 public String getTime() throws CORBA.SystemException {
 return "Time: " + currentTime;
 }
};
```



## Server Implementation

```
// TimeServer_Server.java
import CORBA.*;
public class TimeServer_Server{
 public static void main(String[] argv) {
 try {
 CORBA.ORB orb = CORBA.ORB.init();
 ...
 ObjTestTimeServerImpl obj =
 new ObjTestTimeServerImpl (...);
 ...
 System.out.println(orb.object_to_string(obj));
 }
 catch (CORBA.SystemException e) {
 System.err.println(e);
 }
 }
};
```



## Client Implementation (Simpler Protocol)

```
// TimeServer_Client.java
import CORBA.*;
public class TimeServer_Client{
 public static void main(String[] argv){
 try {
 CORBA.ORB orb= CORBA.ORB.init();
 ...
 CORBA.Object obj = orb.string_to_object(argv[0]);
 ...
 TestTimeServer.ObjTimeServer timeServer =
 TestTimeServerImpl.ObjTimeServer_var.narrow(obj);
 ...
 System.out.println(timeServer.getTime());
 }
 catch (CORBA.SystemException e){
 System.err.println(e);
 }
 }
};
```



## Execution

```
// starting server
C:\> java TimeServer_Server
IOR:0000000000122342435 ...

// starting client
C:\> java TimeServer_Client IOR:0000000000122342435 ...

Time: 14:35:44
```





# ORBS

- ▶ **Java-based**
  - IBM WebSphere
  - IONA Orbix: In Java, ORBlets possible
  - BEA WebLogic
  - Visibroker (in Netscape)
  - Voyager (ObjectSpace) (with Mobile Agents)
  - free: JacORB, ILU, Jorba, DynaORB
- ▶ **C-based**
  - ACE ORB TAO, University Washington (with trader)
  - Linux ORBIT (gnome)
  - Linux MICO
- ▶ **Python-based**
  - fnorb
- ▶ <http://www.omg.org>



## 11b.2.2 Trader-Based Call



The foundation of service-oriented architecture (SOA)

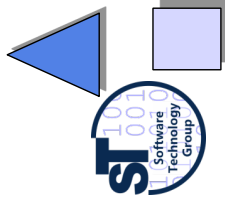

## Beyond Dynamic Call: Service Call with the Trader Service

- ▶ A service call is a call, not based on naming but on semantic attributes, published properties
  - Requires a yellow page directory of services
- ▶ Service-oriented architectures (SOA), requires matchmaking of services
  - The ORB resolves operations still based on naming (with the name service). The trader, however, resolves services without names, only based on properties and policies
- ▶ The trader gets offers from servers, containing new services

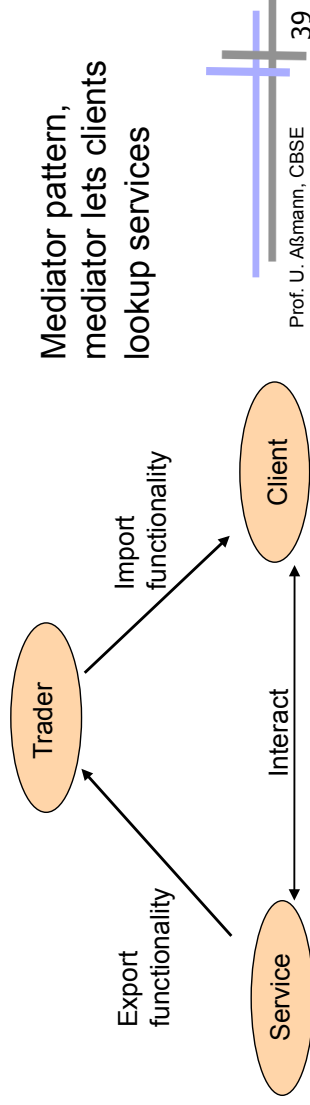

## Service Offers for Trader

- ▶ Service offer (IOR with properties (metadata))
  - Properties describe services
  - Are used by traders to match services to queries
  - *not* facet-based, one-dimensional
- ▶ Dynamic property
  - A property can be queried dynamically by the trader of service
  - The service-object can determine the value of a dynamic property anew
- ▶ Matching with the standard constraint language
  - Boolean expressions about properties
  - Numeric and string comparisons

# Traders Provide Service Hopping

If a trader doesn't find a service, it calls neighbor traders

- Design pattern Chain of Responsibility
- Graph of traders
  - Links to neighbors via TraderLink
  - TraderLink filters queries and manipulate via policies

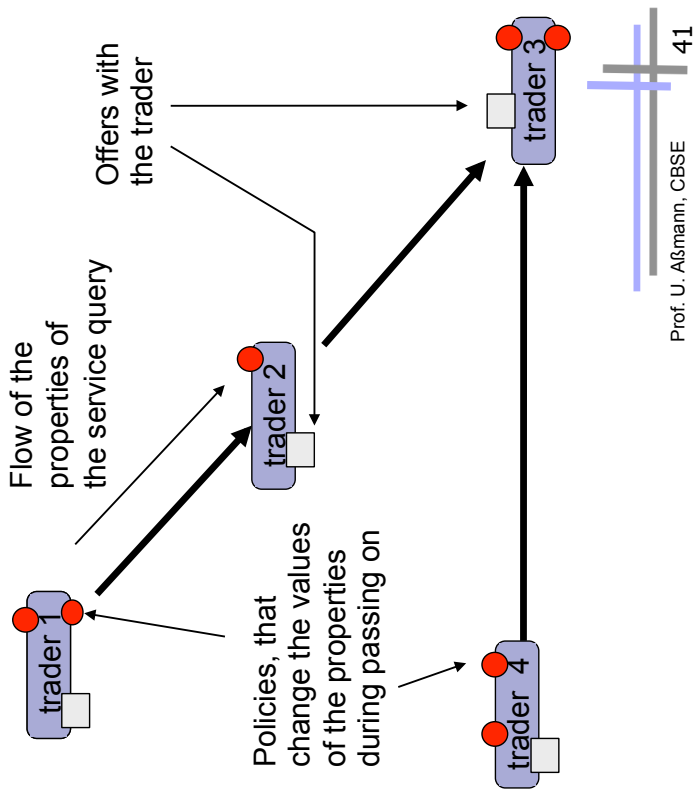

# Modification of Queries

- Policies parameterize the behaviour of the traders and the TraderLinks
  - Filters, i.e., values, modifying the queries:
  - max\_search\_card: maximum cardinality for the ongoing searches
  - max\_match\_card: maximum cardinality for matchings
  - max\_hop\_count: cardinality search depth in the graph

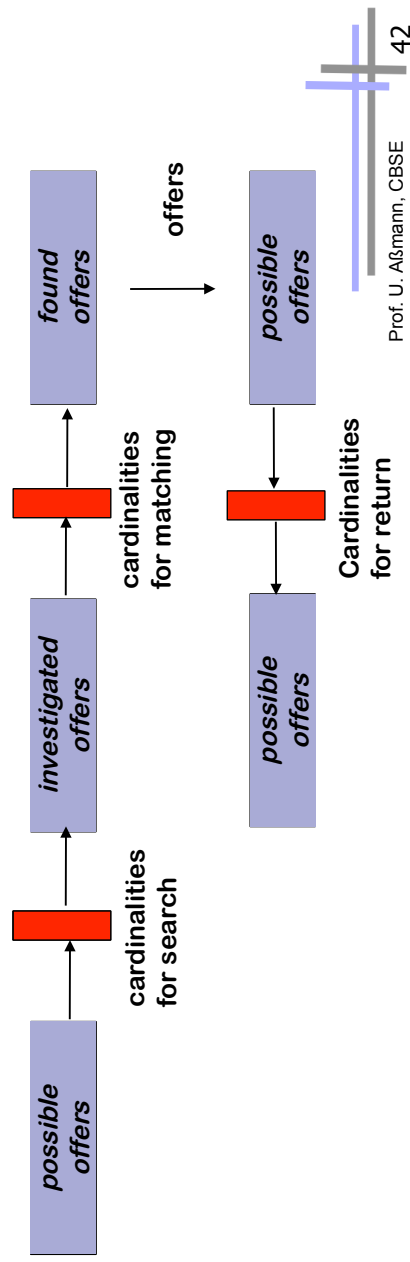



## Interfaces Trading Service

- ▶ Basic interfaces
  - Lookup (query)
  - Register (for export, retract, import of services)
  - Admin (info about services)
  - Link (construction of trader graph)
- ▶ How does a lookup query look like?
  - `Lookup.Query(in ServiceTypeName, in Constraint, in PolicySeq, in SpecifiedProperties, in howTo, out OfferSequence, offerIterator)`
- ▶ Unfortunately, no faceted matchmaking possible!



## CORBA Trader Types

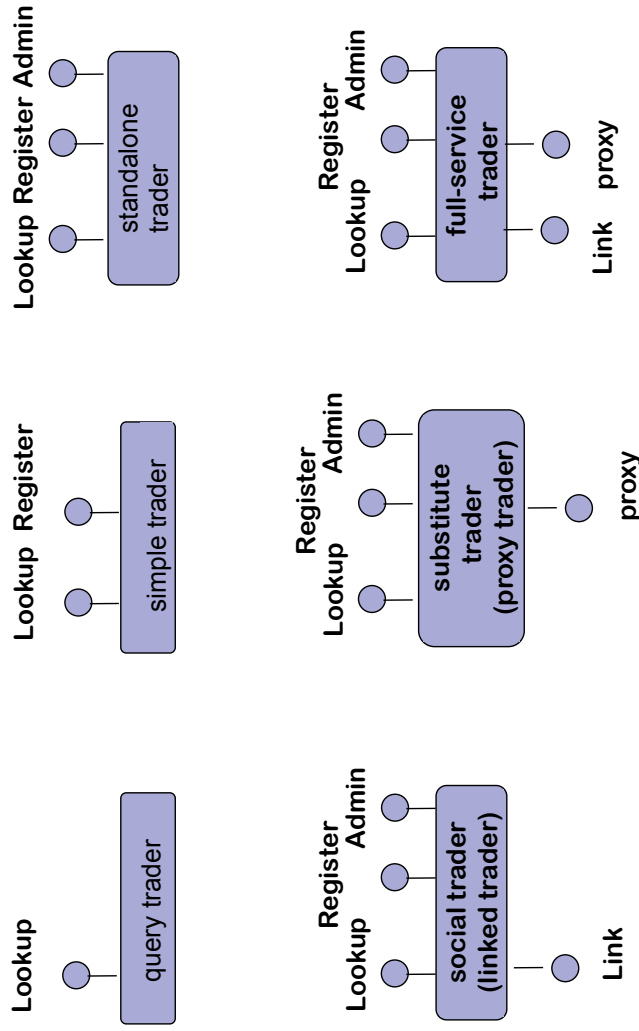

## Corba 3.0

- ▶ Provides the well-defined packaging for producing components
  - CORBA Component Model (CCM): similar to EJB
- ▶ Message Service MOM: Objects have asynchronous buffered message queues
- ▶ Language mappings avoid IDL
  - ▶ Generating IDL from language specific type definitions
  - ▶ C++2IDL, Java2IDL, ...
- ▶ XML integration (SOAP messages)
- ▶ Scripting (CORBA script), a composition language



## 11b.3 Evaluation of CORBA



as composition system

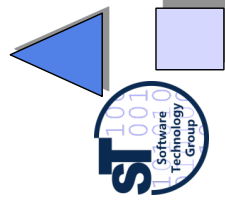

# Component Model

- ▶ Mechanisms for secrets and transparency: very good
  - Interface and Implementation repository
  - Component language hidden (interoperability)
  - Life-time of service hidden
  - Identity of services hidden
  - Location hidden
- ▶ No parameterization
- ▶ Standardization: quite good!
  - Services, application services are available
  - On the other hand, some standards are FAT
  - Technical vs. application specific vs business components:
  - .. but for business objects, the standards must be extended (vertical facilities) (that's where the money is)



# Composition Technique

- ▶ Mechanisms for connection
  - Mechanisms for adaptation
    - Stubs, skeletons, server adapters
  - Mechanisms for glueing: marshalling based on IDL
- ▶ Mechanisms for aspect separation
  - Multiple interfaces per object
    - Facade classes/objects (design pattern facade)
- ▶ Nothing for extensions
- ▶ Mechanisms for meta-modeling
  - Interface Repositories with type codes
  - Implementation repositories
  - Dynamic call and traded call are reflective and introspective
- ▶ Scalability
  - Connections cannot easily be exchanged (except static local and remote call)







## Composition Language

- ▶ Weak: CORBA scripting provides the a facility to write glue code, but only black-box composition



## CORBA

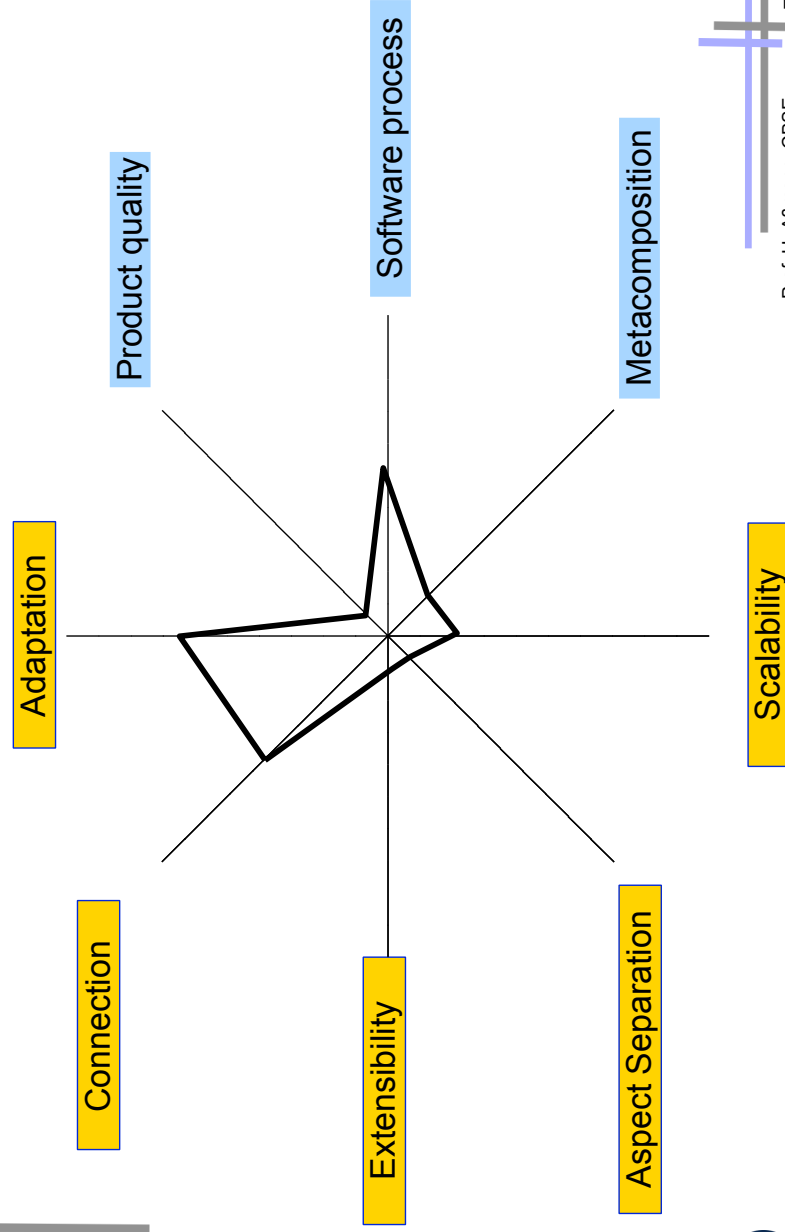

# 11b.4 Corba Services

(optional material)

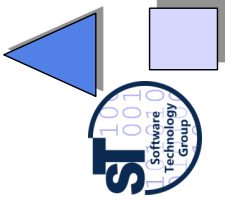

CBSE, © Prof. Uwe Alsmann

51

## Literature

- ▶ OMG. CORBA services: Common Object Service Specifications.  
<http://www.omg.org>.
- ▶ OMG: CORBAfacilities: Common Object Facilities Specifications.



## Overview on Corba Services

- ▶ Services provide functionality a programming language might not provide (e.g, Cobol, Fortran)
- ▶ 16+ standardized service interfaces (i.e., a library)
  - Standardized, but status of implementation different depending on producer
- ▶ **Object services**
  - Deal with features and management of objects
- ▶ **Collaboration services**
  - Deal with collaboration, i.e., object contexts
- ▶ **Business services**
  - Deal with business applications
- ▶ The services serve for criterion M-3, standardization. They are very important to increase reuse.
  - Remember, they are available for every language, and on distributed systems!



## Object Services: Rather Simple

- ▶ **Name service (directory service)**
  - Records server objects in a simple tree-like name space
  - (Is a simple component system itself)
- ▶ **Lifecycle service (allocation service)**
  - Not automatic; semantics of deallocation undefined
- ▶ **Property service (feature service for objects)**
- ▶ **Persistency service (storing objects in data bases)**
- ▶ **Relationship service to build interoperable relations and graphs**
  - Support of standard relations reference, containment
  - Divided in standard roles contains, containedIn, references, referenced
- ▶ **Container service (collection service)**





## Collaboration Services

### ▶ Communication services

- Resemble connectors in architecture systems, but cannot be exchanged to each other
- Event service
  - push model: the components push events into the event channel
  - pull model: the components wait at the channel and empty it
- Callback service

### ▶ Parallelism

- Concurrency service: locks
- Object transaction service, OTS: Flat transactions on object graphs
  - Nested transactions?



## Business Services

### ▶ Trader service

- Yellow Pages, localization of services

### ▶ Query service

- Search for objects with attributes and the OQL, SQL (ODMG-93)

### ▶ Licensing service

- For application providers (application servers)
- License managers

### ▶ Security service

- Use of SSL and other basic services



# Dependencies Between the Services

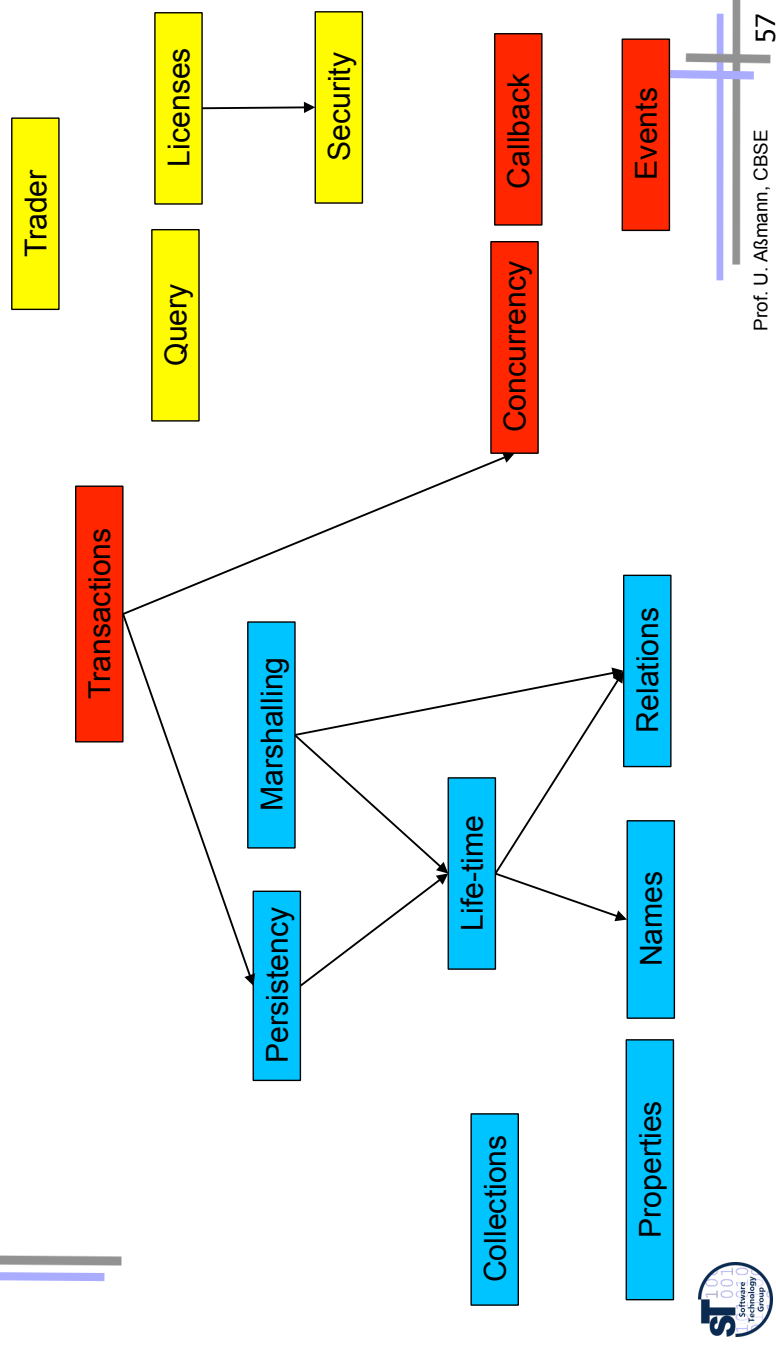

# Object Services: Names

- ▶ Binding of a name associates a name to an object in a name space (directory, scope, naming context)
  - A name space is an associative array with a set of bindings of names to values
  - Namespaces are recursive, i.e., they can reference each other and build name graphs
  - Others: Active Directory, LDAP
- ▶ The representation of a name is based on abstract syntax, not on the concrete syntax of a operating systemor URL.
  - A name consists of a tuple (Identifier, Kind).
  - The identifier is the real name, the Kind tells how the name is represented (e.g., c\_source, object\_code, executable, postscript,...)
  - For creation of names there is a library (design pattern Abstract Factory).



## Name Service CosNaming

CosNaming::NamingContext

```
bind(in Name n, in Object obj) // associate a name
rebind(in Name n, in Object obj)
bind_context
rebind_context
mk_name(String s)
Object resolve
unbind(in Name n) // disassociate a name
NamingContext new_context;
NamingContext bind_new_context(in Name n)
void destroy
void list(..)
_narrow()
```



## Name Service

```
void bind(in Name n, in Object obj)
 raises(NotFound, Cannotproceed, InvalidName, AlreadyBoard);
void rebind(in Name n, in Object obj)
 raises(NotFound, Cannotproceed, InvalidName);
void bind_context(in Name n, in NamingContext nc)
 raises(NotFound, Cannotproceed, InvalidName, AlreadyBoard);
void rebind_context(in Name n, in NamingContext nc)
 raises(NotFound, Cannotproceed, InvalidName);
Name mk_name(String s);
Object resolve(in Name n)
 raises(NotFound, Cannotproceed, InvalidName);
void unbind(in Name n)
 raises(NotFound, Cannotproceed, InvalidName);
NamingContext new_context();
NamingContext bind_new_context(in Name n)
 raises(NotFound, AlreadyBoard, Cannotproceed, InvalidName);
void destroy()
 raises(NotEmpty);
void list(in unsigned long how_many,
 out BindingList bl, out Bindingeserator bi);
```



# Name Service in IDL

```
module CosNaming{
 struct NameComponent {
 string id;
 string kind;
 };
 typedef sequence <NameComponent> Name;
 enum BindingType { noobject, ncontext };
 struct Binding {
 Name binding_name;
 BindingType binding_type;
 };
 typedef sequence <Binding> BindingList;
 interface BindingIterator;
 interface NamingContext {
 enum NotFoundReason { missing_node,
 not_context, not_object };
 exception NotFound {
 NotFoundReason why;
 Name rest_of_name;
 };
 };
 ...
}
}
```



# Use of Names

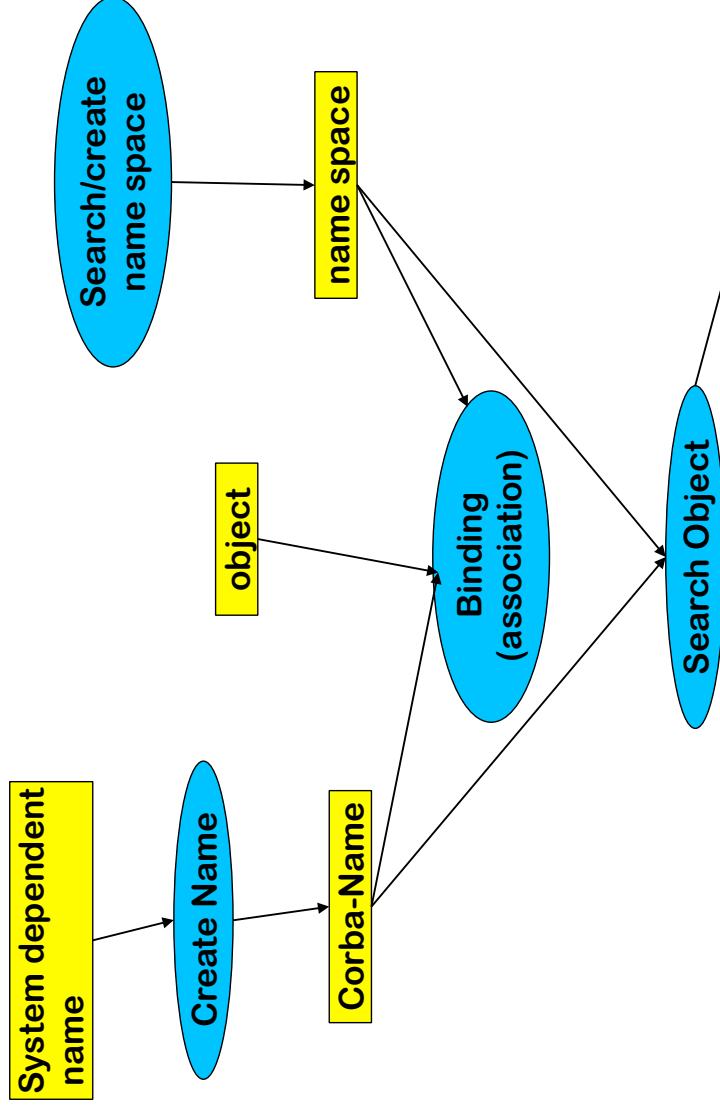

## Name Service: Example

```
// From: RedLich
import java.io.*;
import java.awt.*;
import IE.Iona.Orbix2.CORBA.SystemException; // OrbixWeb
import CosNaming.NamingContext; // name service/context
import CosNaming.NamingContext.*; // name service/Exceptions
import Calc5.calc.complex; // Typ 'complex' from Calc5

class MyNaming extends CosNaming { try {
 ...
}
public class client extends Frame {
 private Calc5.calc.Ref calc;
 private TextField inR, inI;
 private Button setB, addB, multB,
 divB, quitB, zeroB;

 public static void main(String argv[])
 {
 CosNaming.NamingContext.Ref cxt;
 Calc5.calc_factory.Ref cf;
 Frame f;

 cxt= NamingContext._narrow(MyNaming.
 resolve_initial_references(MyNaming.NameService));
 cf = Calc5.calc_factory._narrow(
 cxt.resolve(MyNaming.mk_name("calcfac")));
 f = new client(cf.create_new_calc());
 f.pack();
 f.show();
 }
 catch (Exception ex) {
 System.out.println("Calc-5/Init:" + ex.toString());
 }
}
}
```



## Object Services: Persistence

- ▶ Definition of a Persistent Object Identifier (PID)
  - references the *value* of CORBA-objects (in contrast to a CORBA-object)
- ▶ Interface
  - connect, disconnect, store, restore, delete
- ▶ Attachment to data bases possible (also ODMG compatible)







## Object Services: Property Service

- ▶ Management of lists of features (properties) for objects
  - Properties are strings
  - Dynamically extensible
- ▶ Concept well-known as
  - LISP property lists, associative arrays, Java property classes
- ▶ Iterators for properties
- ▶ Interface:
  - `define_property`, `define_properties`, `get_property_value`, `get_properties`, `delete_property`,



## Collaboration Services: Transactions

- ▶ What a dream: the Web as data base with nested transactions.  
Scenarios:
  - Accounts as Web-objects. Transfers as Transaction on the objects of several banks
  - Parallel working on web sites: how to make consistent?
- ▶ Standard 2-phase commit protocol:
  - `begin_ta`, `rollback`, `commit`
- ▶ Nested transactions
  - `begin_subtransaction`, `rollback_subtransaction`, `commit_subtransaction`



# 11b.5 CORBA Facilities (Standards for Application Domains)

Application domain specific interfaces

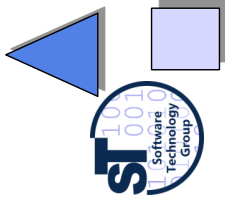

CBSE, © Prof. Uwe Alsmann

67

## Horizontal Facilities

- ▶ **User interfaces**
  - Printing, Scripting
  - Compound documents: since 1996 OpenDoc is accepted as standard format. Source Code has been released of IBM
- ▶ **Information management**
  - Metadata(meta object facility, MOF)
  - Tool interchange: a text- and stream based exchangeformat for UML (XMI)
  - Common Warehouse Model (CWM): MOF-based metaschema for database applications



## Vertical Facilities (Domain-Specific Facilities)

The Domain technology committee (DTC) creates domain task forces DTF for a application domain

- ▶ Business objects
- ▶ Finance/insurance
  - Currency facility
- ▶ Electronic commerce
- ▶ Manufacturing
  - Product data management enablers PDM
- ▶ Medicine (healthcare CorbaMed)
  - Lexicon Query Service
  - Person Identifier Service PIDS
- ▶ Telecommunications
  - Audio/visual stream control object
  - Notification service
- ▶ Transportation



## CORBA Facilities and UML Profiles

▶ Since 2000, the OMG describes domain-specific vocabularies with UML profiles

- Probably, all CORBA facilities will end up in UML profiles

▶ A UML Profile is a UML dialect of a application specific domain

- With new stereotypes and tagged values
- Corresponds to an extension of the UML metamodel
- Corresponds to a domain specific language with own vocabulary
- Every entry in profile is a term

▶ Example UML Profiles:

- EDOC Enterprise Distributed Objects Computing
- Middleware profiles: Corba, .NET, EJB
- Embedded and real time systems:
  - MARTE profile on schedulability, performance, time
  - Ravenscar Profile
  - HIDOORS Profile on real-time modelling [www.hidoors.org](http://www.hidoors.org)

## 11b.6. CORBA and the Web

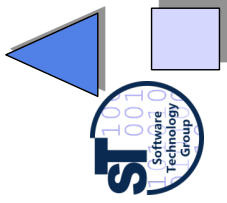

CBSE, © Prof. Uwe Alsmann

71

## Corba and the Web



- ▶ HTML solves many of the CORBA problems
- ▶ HTTP only for data transport
  - HTTP cannot call methods, except by CGI-Gateway-functionality (common gateway interface)
  - Behind the CGI-interface is a general program, communicating with HTTP with untyped environment variables (HACK!)
  - http-Server are simple ORBs, pages are objects
  - The URI/URL-name schema can be integrated into CORBA
- ▶ IIOP becomes a standard internet protocol
  - Standard ports, URL-mappings and Standard-proxies for Firewalls are available
- ▶ CORBA is an extension of HTTP of data to code



## CORBA and Java

- ▶ Java is an ideal partner for Corba :
  - Bytecode is mobile, i.e.,
    - Applets: move calculations to clients (thin/thick client problem)
    - can be used for migration of objects, ORBs and agents
  - Since 1999 direct Corba support in JDK 1.2
    - IDL2Java mapping, IDL compiler, Java2IDL compiler, name service, ORB
  - Corba supports for Java a distributed interoperable infrastructure
- ▶ Java imitates functionality of Corba
  - Basic services: Remote Method Invocation RMI, Java Native code Interface JNI
  - Services: serialization, events
  - Application specific services (facilities): reflection, properties of JavaBeans



## Corba and the Web (Orblets)

- ▶ ORBs can be written as bytecode applets if they are written in Java (ORBlet)
- ▶ Coupling of HTTP and IOP: Download of an ORBlets with HTTP: Talk to this ORB, to get contact to server
- ▶ Standard web services (see later) are slower than CORBA/ORBlets, because they incur interpretation overhead

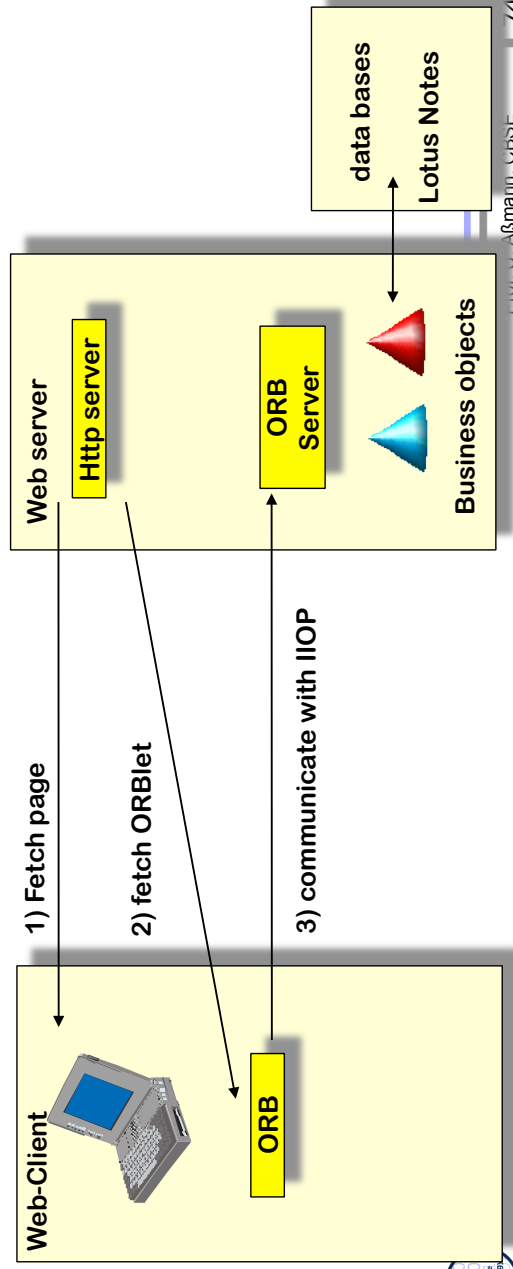



## What Have We Learned

- ▶ CORBA is big, but universal:
  - The Corba-interfaces are very flexible, work and can be used in practice
  - .. but also complex and fat, may be too flexible
  - If you have to connect to legacy systems, CORBA works
- ▶ Corba has the advantage of an open standard
- ▶ To increase reuse and interoperability in practice, one has to learn *many* standards
- ▶ Trading and dynamic call are future advanced communication mechanisms
- ▶ CORBA was probably only the first step, but web services might be taking over



## The End

