

Component-Based Software Engineering (CBSE)

1) Introduction

1. Basics of Composition Systems
2. Historic Approaches to Black-Box Composition
3. Gray-Box Composition

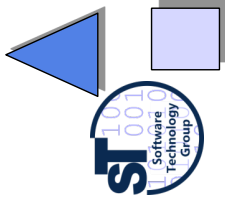

Prof. Dr. Uwe Aßmann

Technische Universität Dresden
Institut für Software- und
Multimediatechnik

<http://st.inf.tu-dresden.de>

12-1.1, 11.04.12

CBSE, © Prof. Uwe Aßmann

1

Goals

- ▶ Understand what a *composition system* is
 - ▶ The difference of component-based and composition-based systems
 - ▶ The difference of component and composition systems
 - ▶ What is a composition operator? composition expression? composition program? composition language?
- ▶ Understand the difference between graybox and blackbox systems (variability vs. extensibility)
- ▶ Understand the ladder of composition systems
 - ▶ Understand the criteria for comparison of composition systems



Obligatory Reading

- ▶ [ISC], Chapter 1, Chapter 2
- ▶ Douglas McIlroy's home page
<http://cm.bell-labs.com/who/doug/>
- ▶ [McIlroy] Douglas McIlroy. Mass Produced Software Components. In P. Naur and B. Randell, "Software Engineering, Report on a conference sponsored by the NATO Science Committee, Garmisch, Germany, 7th to 11th October 1968", Scientific Affairs Division, NATO, Brussels, 1969, 138-155.
<http://cm.bell-labs.com/cm/cs/who/doug/components.txt>



1.1. Basics of Composition Systems

Component-based software engineering is built on **composition systems**.

A composition system has a component model, a composition technique, and a composition language.

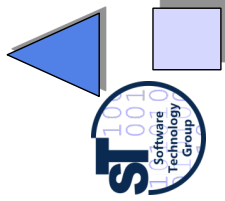



Motivation for Component-Based Development

- ▶ Divide-and-conquer (Alexander the Great)
 - Well known in other disciplines
 - Mechanical engineering (e.g., German VDI 2221)
 - Electrical engineering
 - Architecture
- ▶ Outsourcing to component producers
 - Components off the shelf (COTS)
 - Goal:
 - Reuse of partial solutions
 - Easy configurability of the systems: variants, versions, product families
- ▶ Mass Produced Software Components [McIlroy]
 - Garmisch 68, NATO conference on software engineering
 - Every ripe industry is based on components, since these allow to manage large systems
 - Components should be produced in masses and composed to systems afterwards



Mass-produced Software Components

In the phrase 'mass production techniques,' my emphasis is on 'techniques' and not on mass production plain. Of course mass production, in the sense of limitless replication of a prototype, is trivial for software.

But certain ideas from industrial technique I claim are relevant.

- The idea of subassemblies carries over directly and is well exploited.
- The idea of interchangeable parts corresponds roughly to our term 'modularity,' and is fitfully respected.
- The idea of machine tools has an analogue in assembly programs and compilers.

Yet this fragile analogy is belied when we seek for analogues of other tangible symbols of mass production.

- There do not exist manufacturers of standard parts, much less catalogues of standard parts.
- One may not order parts to individual specifications of size, ruggedness, speed, capacity, precision or character set.





Mass-produced Software Components

- ▶ Later McIlroy was with Bell Labs,
 - ..and invented pipes, diff, join, echo (UNIX).
 - Pipes are still today the most employed component system!
- ▶ Where are we today?



Real Component Systems

- ▶ Lego
- ▶ Square stones
- ▶ Building plans
- ▶ IC's
- ▶ Hardware bus
- ▶ How do they differ from software?

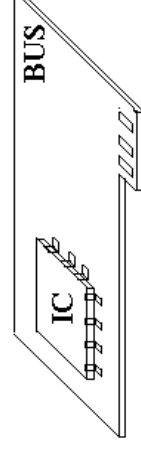
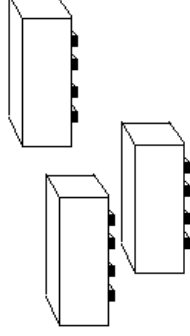



Definitions of Components

A software component is a unit of composition

- with contractually specified interfaces
- and explicit context dependencies only.

A software component

- can be deployed independently and
- is subject to composition by third parties.

(ECOOP Workshop WCOP 1997 Szyperski)

A reusable software component is a

- logically cohesive,
- loosely coupled module
- that denotes a single abstraction. (Grady Booch)

A software component is a static abstraction with plugs.

(Nierstrasz/Dami)



What is a Software Component?

- ▶ A component is a *container with*
 - *content* (most often code snippets/fragments)
 - *variation points*
 - *extension points*
 - that are adapted during composition
- ▶ A component is a *reusable unit for composition*
- ▶ A component underlies a *component model*
 - that fixes the abstraction level
 - that fixes the grain size (widget or OS?)
 - that fixes the time (static or runtime?)





What Is A Component-Based System?

- ▶ A component-based system has the following divide-and-conquer feature:
 - A component-based system is a system in which a major relationship between the components is **tree-shaped or reducible**.
 - See course Softwaretechnologie-II
- ▶ **Consequence:** the entire system can be reduced to one abstract node
 - at least along the structuring relationship
- ▶ **Systems with layered relations (dag-like relations) are not necessarily component-based.**
 - Because they cannot be reduced
- ▶ **Because of the divide-and-conquer property, component-based development is attractive.**
 - ▶ However, we have to choose the structuring relation and the composition model
- ▶ **Mainly, 2 types of component models are known**
 - Modular decomposition (blackbox)
 - Separation of concerns (graybox)



Component Systems (Component Platforms)

- ▶ We call a technology in which component-based systems can be produced a *component system* or *component platform*.
- ▶ A component system has

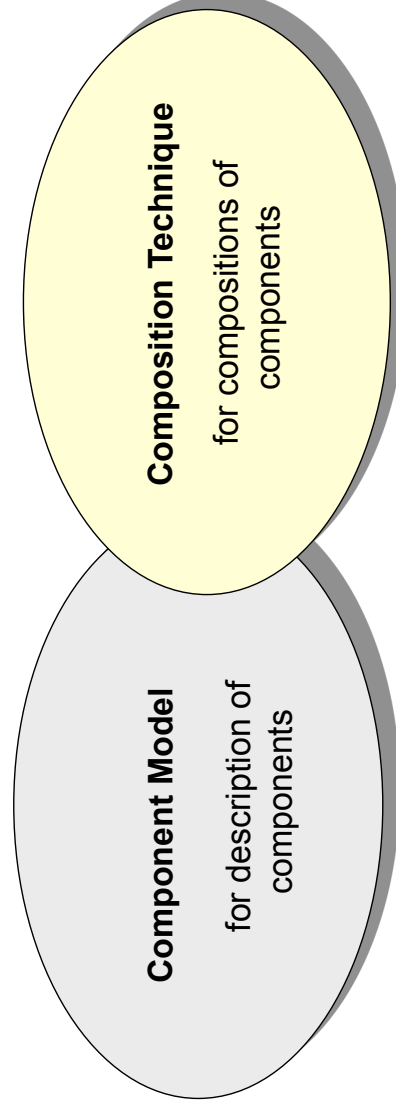

Composition Systems

- ▶ A composition system has

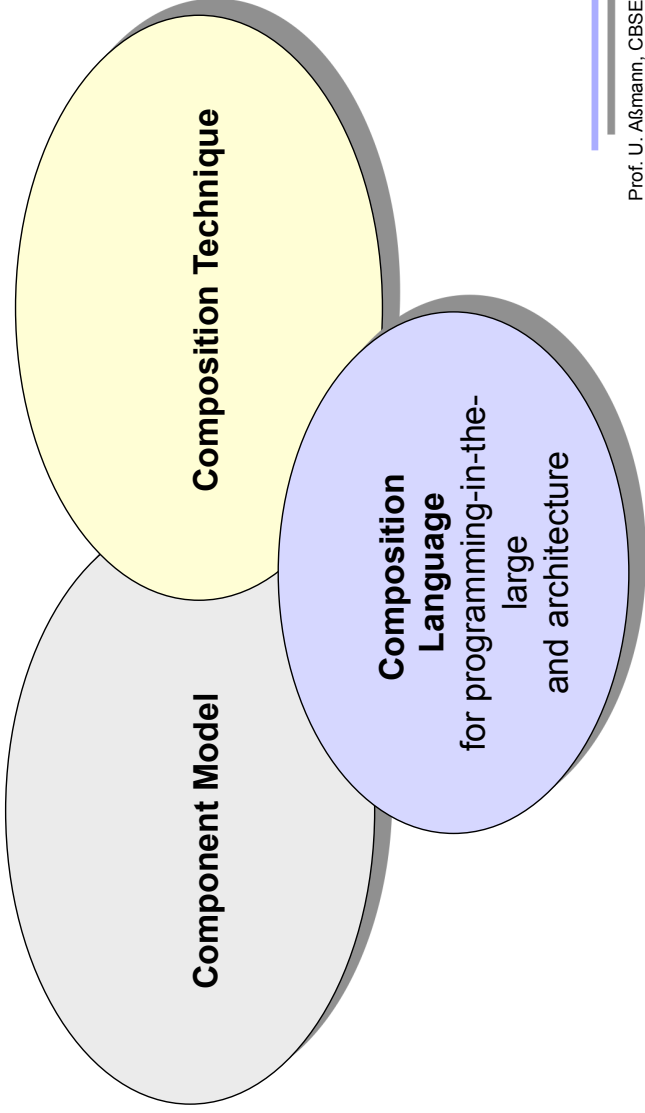

The Ladder of Composition Systems

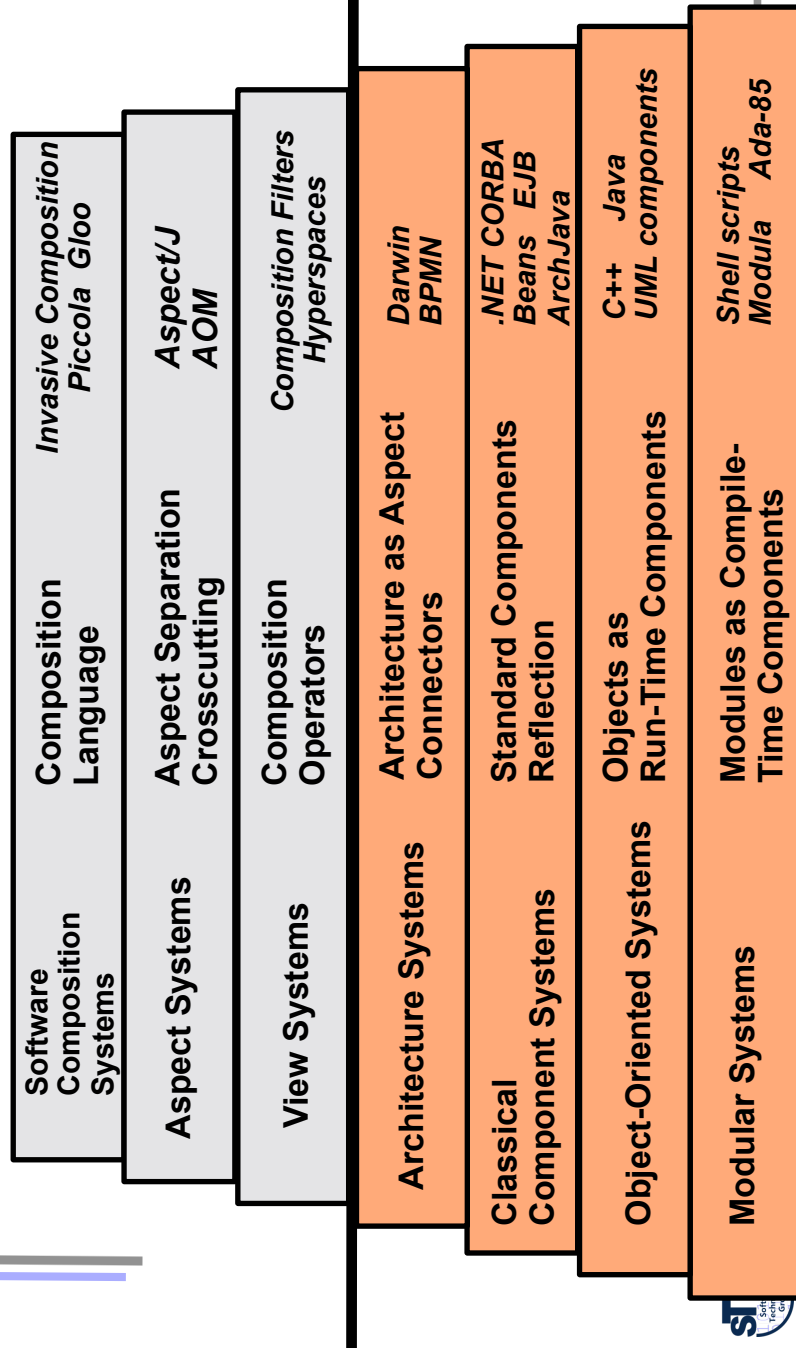



Desiderata for Flexible Software Composition

- ▶ **Component Model:**
 - How do components look like?
 - Secrets, interfaces, substitutability
- ▶ **Composition Technique**
 - How are components plugged together, composed, merged, applied?
 - Composition time (Deployment, Connection, ...)
- ▶ **Composition Language**
 - How are compositions of large systems described?
 - How are system builds managed?
- ▶ **Be aware: this list is NOT complete!**



Desiderata Component Model

- ▶ **CM-M: Modularity**
 - M1 Component interfaces and secrets (information hiding):
 - Explicit specification of interfaces (contact points, exchange points, binding points, variation points, extension points)
 - Explicit specification of dependencies: Provided and required interfaces
 - Location, way of deployment
 - Component lifetime
 - M2 Semantic substitutability (conformance, contracts)
 - Syntactic substitutability (typing)
 - M2.1 Quality contracts
 - M3 Content
 - Component language metamodel
- ▶ **CM-P: Parameterization of components to their reuse context**
 - P1 Generic type parameters
 - P2 Generic program elements
 - P3 Property parameterization
- ▶ **CM-S: Standardization**
 - S1 Open standards – or proprietary ones
 - S2 Standard components
 - S3 Standard services





Desiderata Composition Technique

- ▶ **CT-C: Connection and Adaptation**
 - C1: Automatic Component Adaptation: adapt the component interface to another interface
 - C2: Automatic Glueing: Generation of glue code for communication, synchronization, distribution. Consists of a sequence of adaptations
- ▶ **CT-E: Extensibility**
 - E1: Base Class Extension: can base classes be extended?
 - E1.1 Generated factories: can factories be generated
 - E1.2 Generated access layers
 - E2: Views. Use-based extensions: Can a use of a component extend the component?
 - E3: Integrated Extensions. Can extensions be integrated?
- ▶ **CT-A: Aspect separation**
 - AS1: Aspect weaving: Extension by crosscutting views
 - AS2: Multiple interfaces of a component
- ▶ **CT-S: Scalability (Composition time)**
 - SC1: Binding time hiding
 - SC2: Binding technique hiding
- ▶ **CT-M: Metamodelling**
 - MM1: Introspection and reflection (metamodel). Can other components be introspected? The component itself?
 - MM2: Metaobject protocol: is the semantics of the component specified reflectively?
- **CT-I: Tool support for composition**
 - Editors, checkers, validators



Desiderata Composition Language

- ▶ **CL-C: Product Consistency**
 - Variant cleanness: consistent configurations
 - Robustness: absence of run-time exceptions
- ▶ **CL-P: Software Process Support**
 - Build management automation
- ▶ **CL-M: Meta-composition**
 - Is the composition language component-based, i.e., can it be composed itself?
 - Reuse of architectures
- ▶ **CL-A: Architectural styles (composition styles)**
 - Constraints for the composition





Service Components

- ▶ A *service component* is a software component whose location, style of deployment, and name is not known.
 - It is described by metadata (attributes)
 - [from Greenfield/Short, Software Factories, AWL]



1.2 Historical Approaches to Components

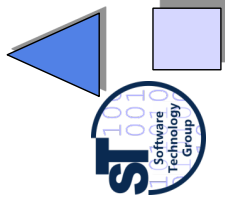

The Essence of the 60s-90s: LEGO Software with Black-Box Composition

- ▶ Procedural systems, stream-based systems
- ▶ Modular systems
- ▶ Object-oriented technology
- ▶ Component-based programming
 - CORBA, EJB, DCOM, COM+, .NET, OSGI
- ▶ Architecture languages

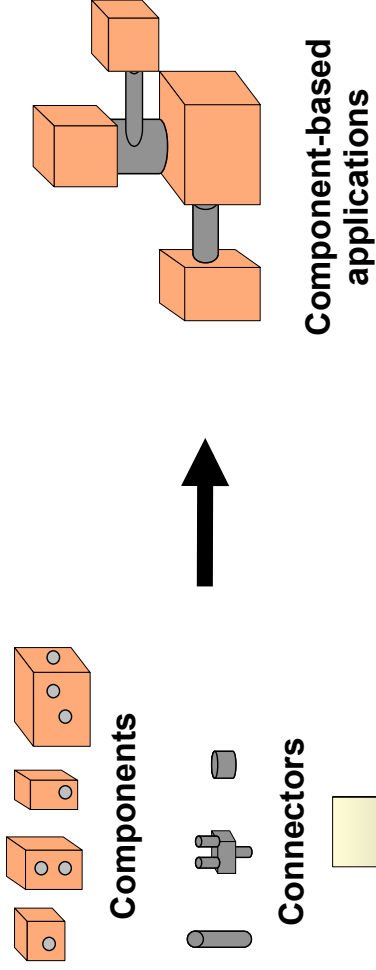

Procedure Systems

- ▶ Fortran, Algol, C
- ▶ The procedure is the static component
- ▶ The activation record the dynamic one
- ▶ Component model is supported by almost all chips directly
 - jumpSubroutine -- return

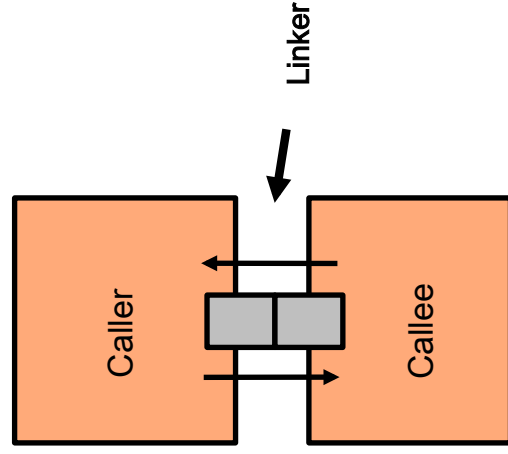

Procedures as Composition System

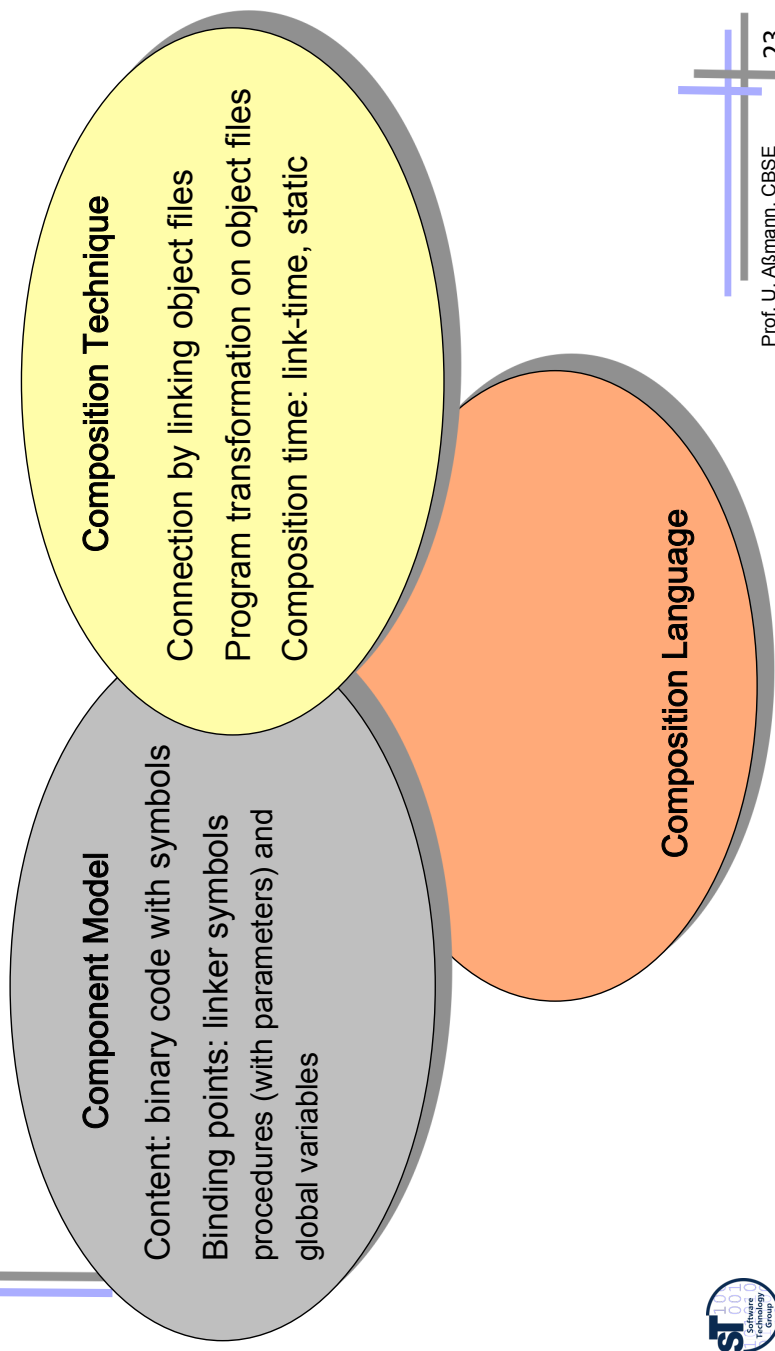

Modules (Information-Hiding-Based Design a la Parnas)

- ▶ Every module hides the an important design decision behind a well-defined interface which does not change when the decision changes.

We can attempt to define our modules “around” assumptions which are likely to change. One then designs a module which “hides” or contains each one.

Such modules have rather abstract interfaces which are relatively unlikely to change.

- Static binding of functional interfaces to each other
- Concept has penetrated almost all programming languages (Modula, Ada, Java, C++, Standard ML, C#)

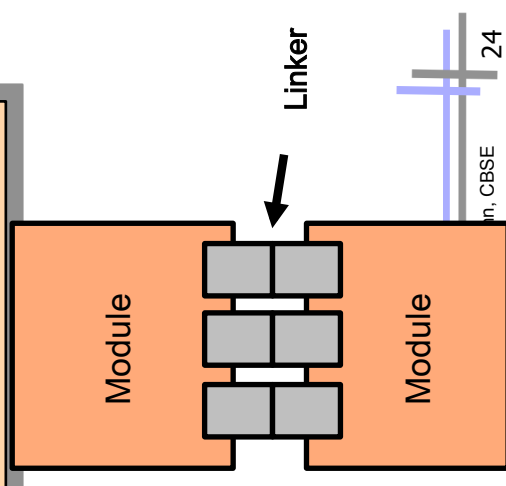

A Linker is a Static Composition Operator

- ▶ Static linkers compose modules at link time
- ▶ Dynamic linkers at run time

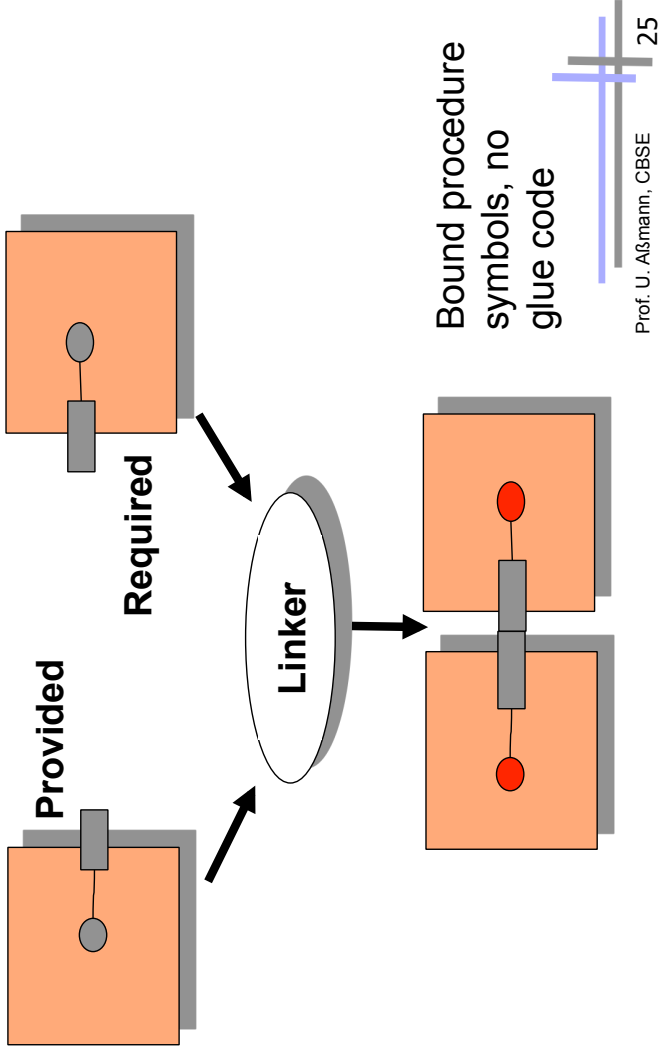

Modules as Composition System

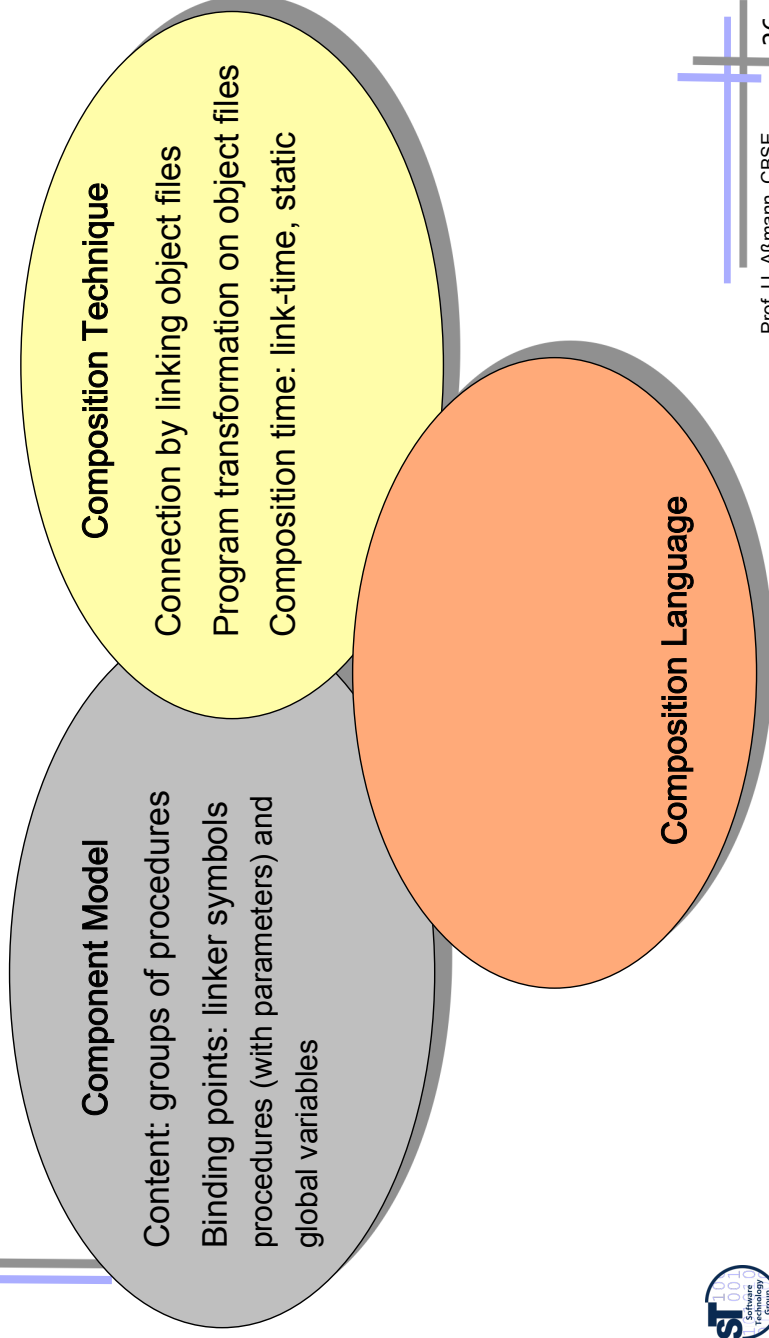



UNIX Pipes and Filters (McIlroy)

- ▶ Communication can take place once or many times
 - ▶ By **Calls** (singular) or **Streams** (continuous)
- ▶ UNIX shells offer a component model for streams
 - Extremely flexible, simple
 - Communication with byte streams, parsing and linearizing the objects
- ▶ **Component model**
 - Content: unknown (depends on parsing), externally bytes
 - Binding points: stdin/stdout/stderr ports
 - More secrets: distribution, parallelism etc
- ▶ **Composition technique: manipulation of byte streams**
 - Adaptation: filter around other components. Filter languages such as sed, awk, perl
 - Binding time: static, streams are connected (via filters) during composition
- ▶ **Composition languages**
 - C, shell, tcl/tk, python, perl...
 - Build management language makefile

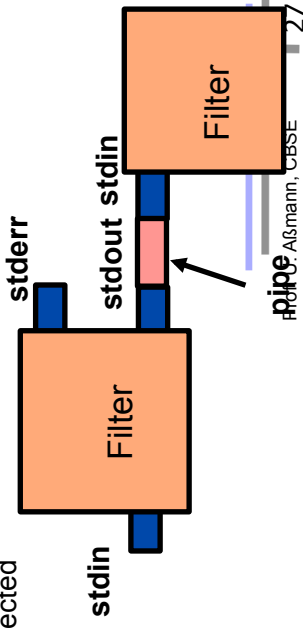

Shells and Pipes as Composition System





Communication

- Black-box components communicate either
 - Via calls (singular): → algebraic data types, induction
 - Via streams (continuous) → coalgebraic data types, coinduction



Object-Oriented Systems

- ▶ Components: objects (runtime) and classes (compile time)
 - Objects are instances of classes (modules) with unique identity
 - Objects have runtime state
 - Late binding of calls by search at runtime

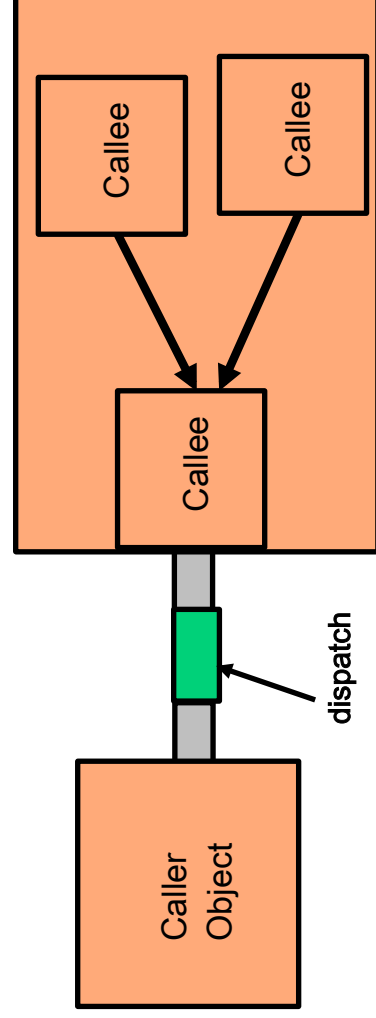



Object-Oriented Systems

- ▶ **Component Model**
 - Content: code (static) and values (dynamic)
 - Binding points:
 - monomorphic calls (static calls)
 - polymorphic calls (dynamically dispatched calls)
- ▶ **Composition Technique**
 - Adaptation by inheritance or delegation
 - Extensibility by subclassing
- ▶ **Composition Language: none**



Object-Orientation as Composition System

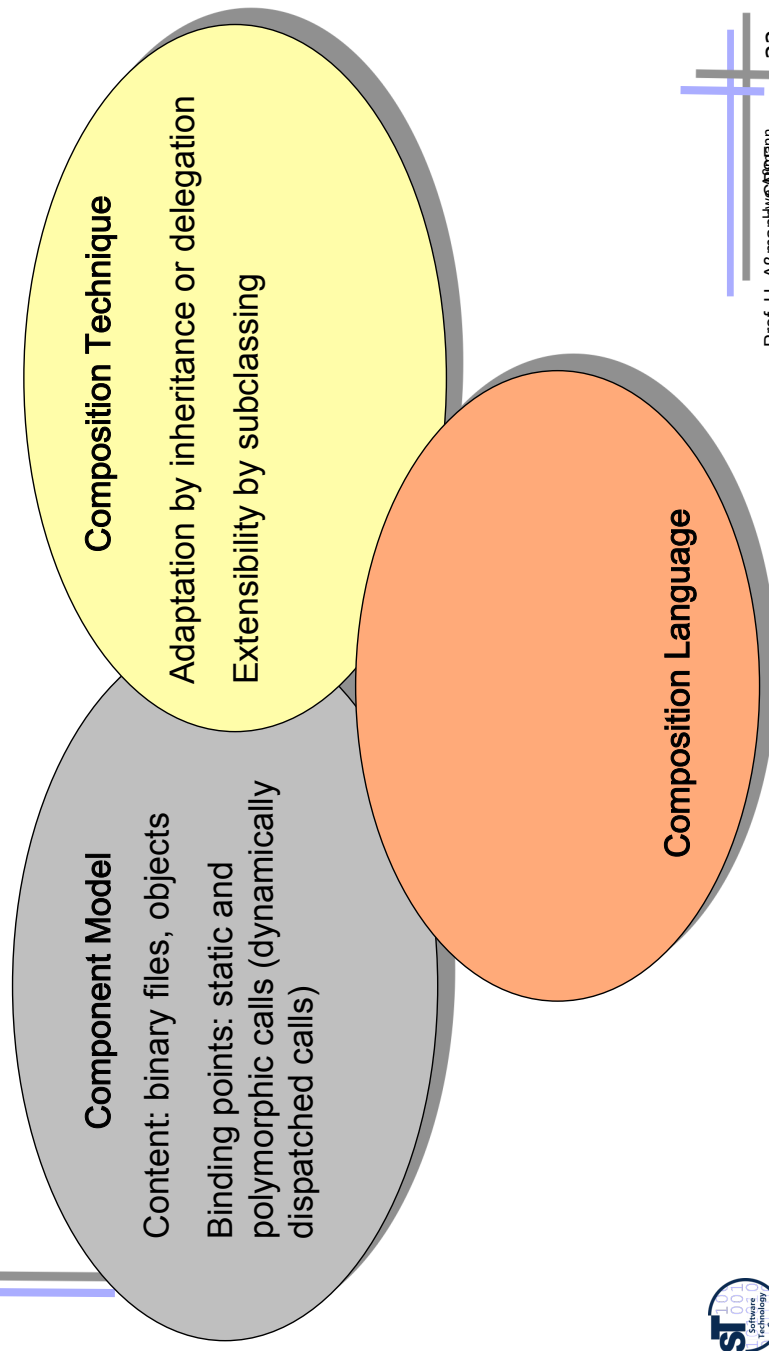

Object-Oriented Systems: Frameworks

- ▶ [Pree] An object-oriented framework consists of a set of template classes which can be parameterized by *hook classes* (*parameter classes*)
- ▶ This principle can be transferred to many other composition systems

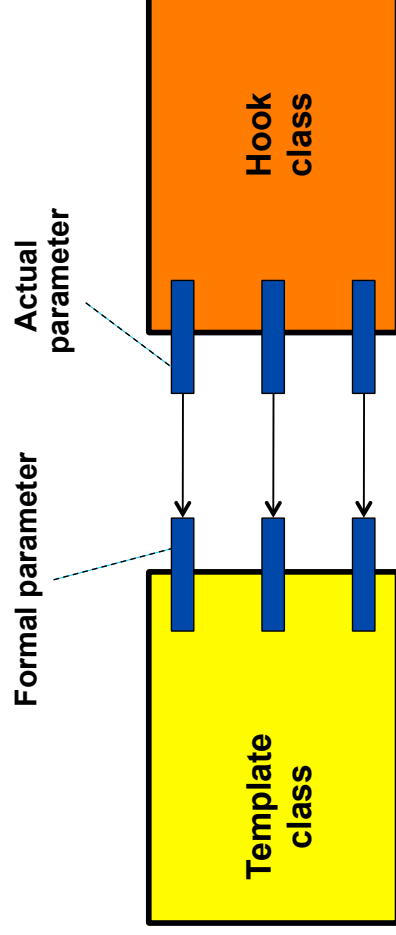

O-O Frameworks

- ▶ Component Model
 - Binding points: Hot spots to exchange the parameter classes (sets of polymorphic methods)
 - Variation points: 1 out-of n choice
 - Extension points: arbitrarily many extensions
- ▶ Composition Technique
 - Same as OO
- ▶ Composition language
 - Same as OO

Commercial Component Systems (COTS, Components off the Shelf)

- ▶ CORBA/DCOM/.NET/JavaBeans/EJB
- ▶ Although different on the first sight, turn out to be rather similar

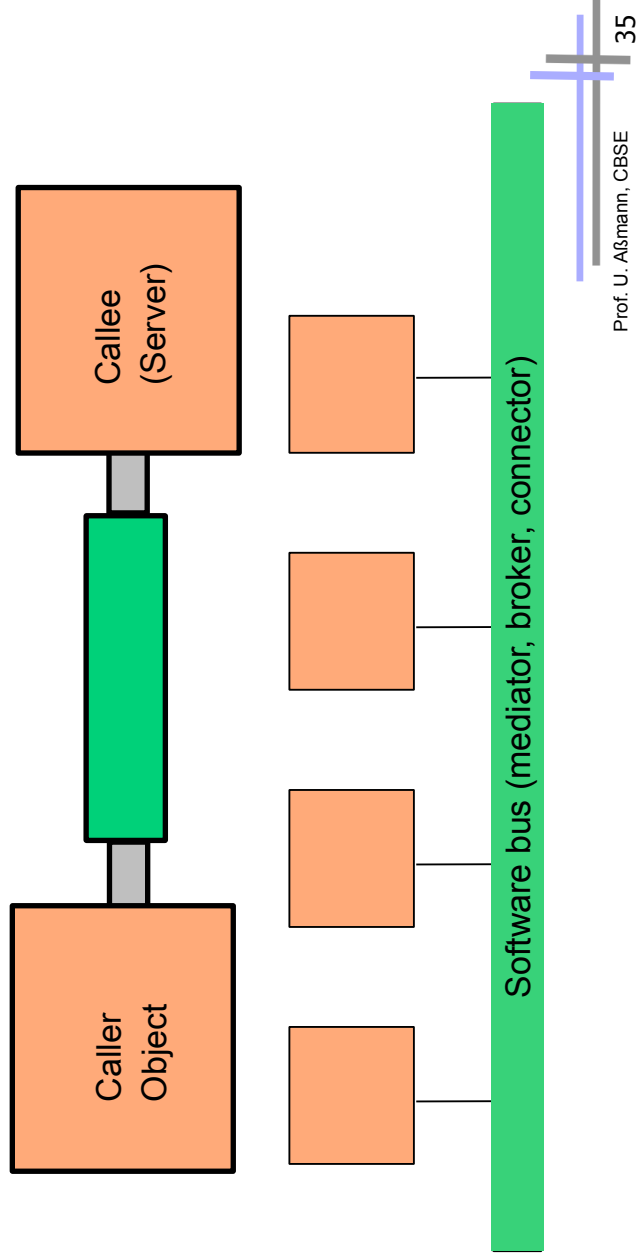

CORBA

<http://www.omg.org/corba>

- ▶ Language independent, distribution transparent
- ▶ interface definition language IDL
- ▶ source code or binary

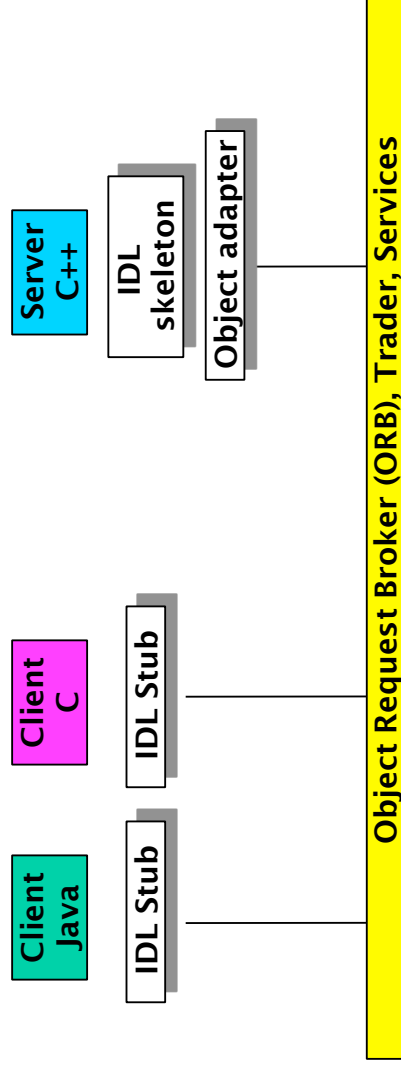

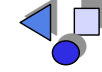

(D)COM(+), ActiveX

<http://www.activex.org>

- ▶ Microsoft's model is similar to CORBA. Proprietary
- ▶ DCOM is a binary standard

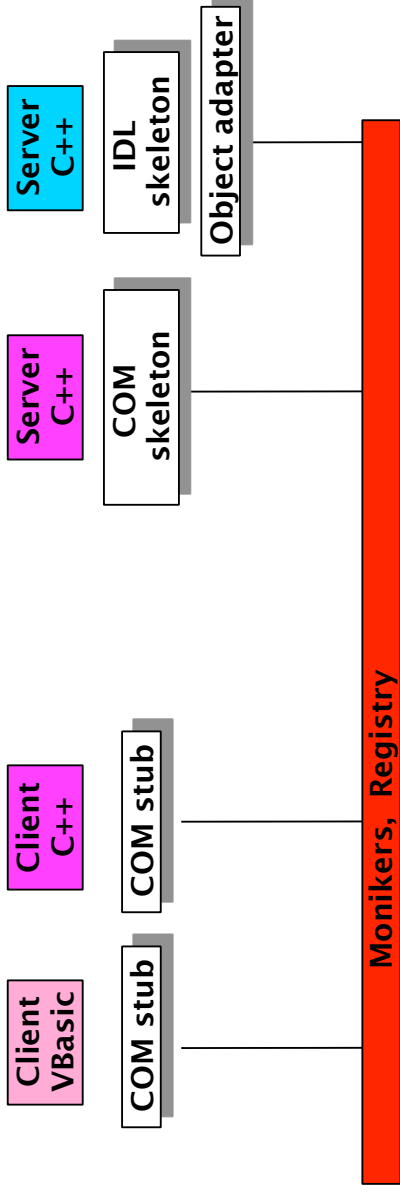

Java Enterprise Beans

- ▶ Java only, event-based, transparent distribution by remote method invocation (RMI)
- ▶ source code/bytecode-based

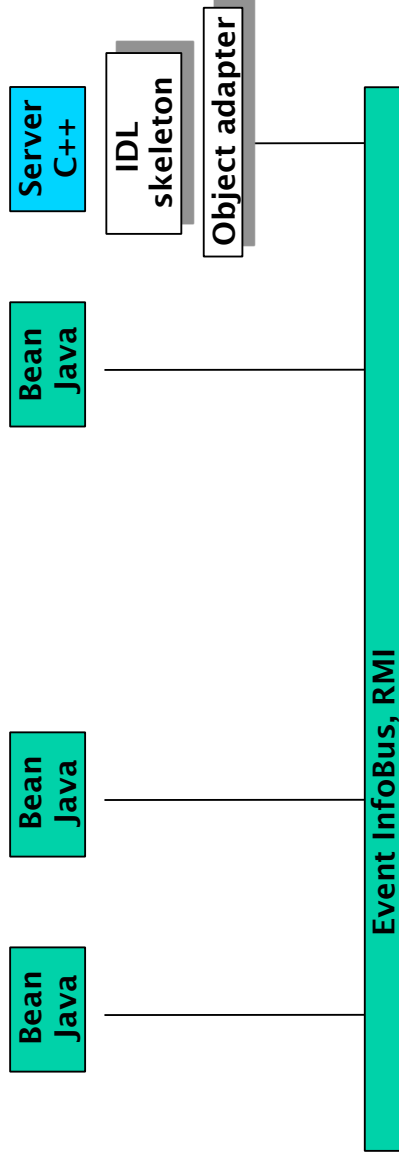

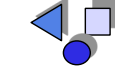

.NET <http://www.microsoft.com>

- ▶ Language independent, distribution transparent
- ▶ NO interface definition language IDL (at least for C#)
- ▶ source code or bytecode MSIL
- ▶ Common Language Runtime CLR

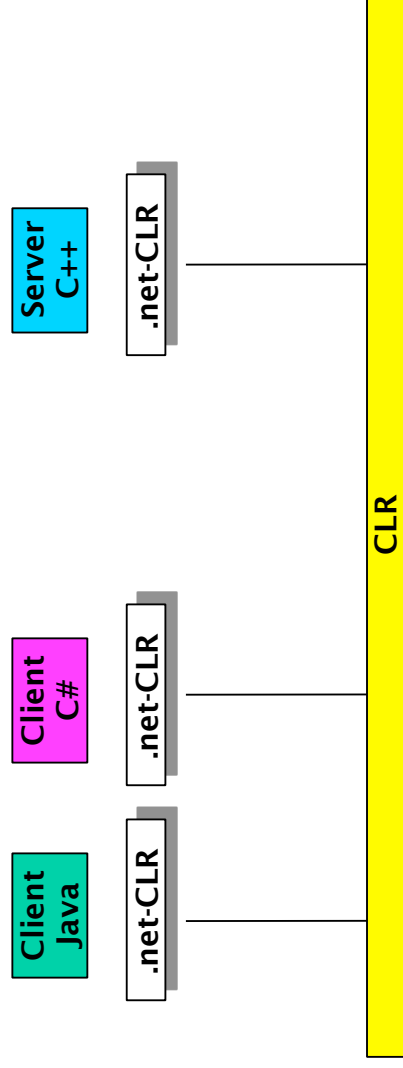

COTS

- ▶ **Component Model**
 - Content: binary components
 - Secrets: Distribution, implementation language
 - Binding points are standardized
 - Described by IDL languages
 - set/get properties
 - standard interfaces such as IUnknown (QueryInterface)
- ▶ **Composition Technique**
 - External adaptation for distributed systems (marshalling) and mixed-language systems (IDL)
 - Dynamic call in CORBA
- ▶ **Composition Language**
 - e.g., Visual Basic for COM



COTS as Composition System



Architecture Systems

- ▶ Unicon, ACME, Darwin, Reo
 - feature an Architecture Description Language (ADL)
- ▶ Split an application into:
 - Application-specific part (encapsulated in components)
 - Architecture and communication (in architectural description in ADL)
 - Better reuse since both dimensions can be varied independently

Component Model in Architecture Systems

- ▶ **Ports** abstract interface communication points
 - in(data), out(data)
 - Components may be nested
- ▶ **Connectors** as special communication components
- ▶ **Coordinators** as higher-level architectural styles

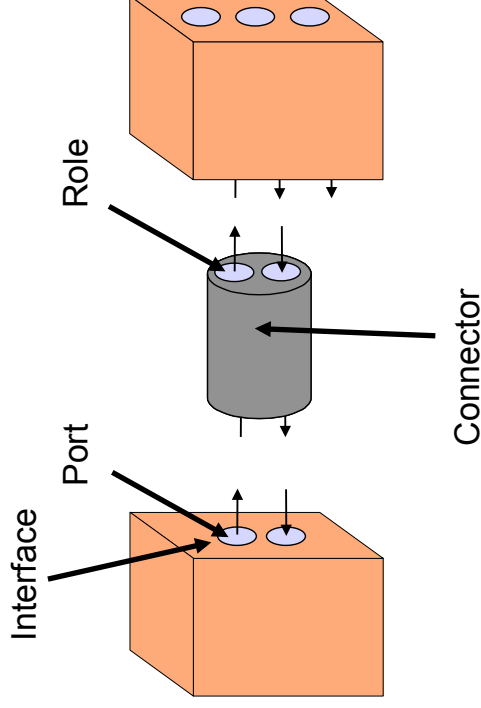

Architecture can be exchanged independently of components

- ▶ Reuse of components and architectures is fundamentally improved

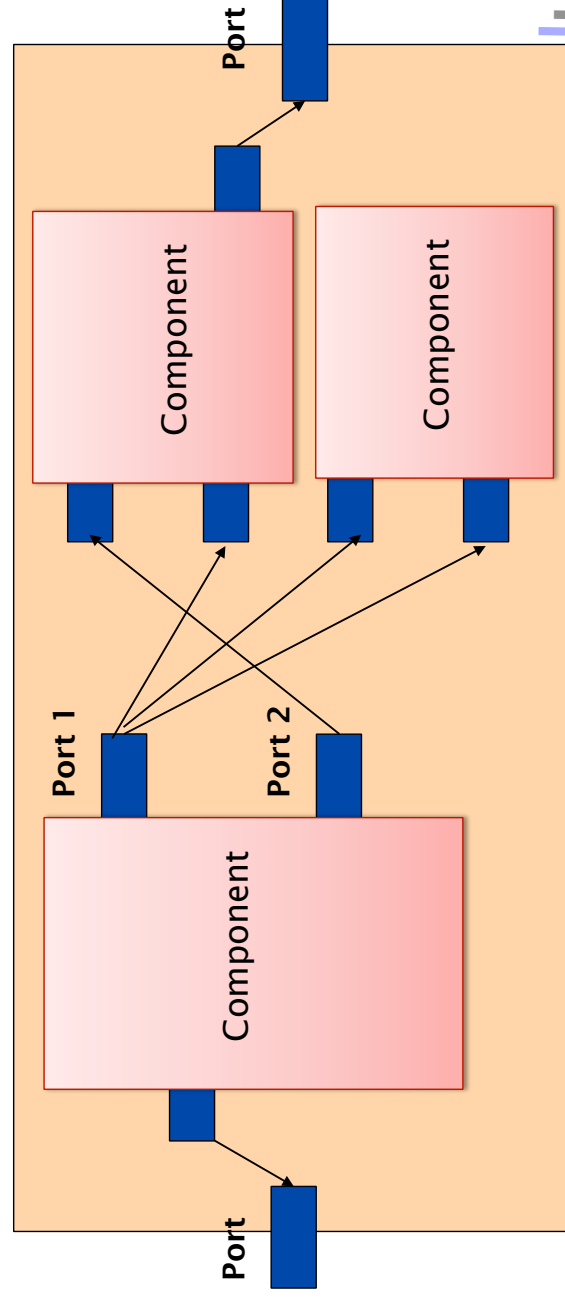



The Composition Language: ADL

- ▶ Architecture language (architectural description language, ADL)
 - ADL-compiler
 - XML-Readers/Writers for ADL. XADL is a new standard exchange language for ADL based on XML
- ▶ Graphic editing of systems
- ▶ Checking, analysing, simulating systems
 - Dummy tests
 - Deadlock checkers
 - Liveness checking



ACME Studio

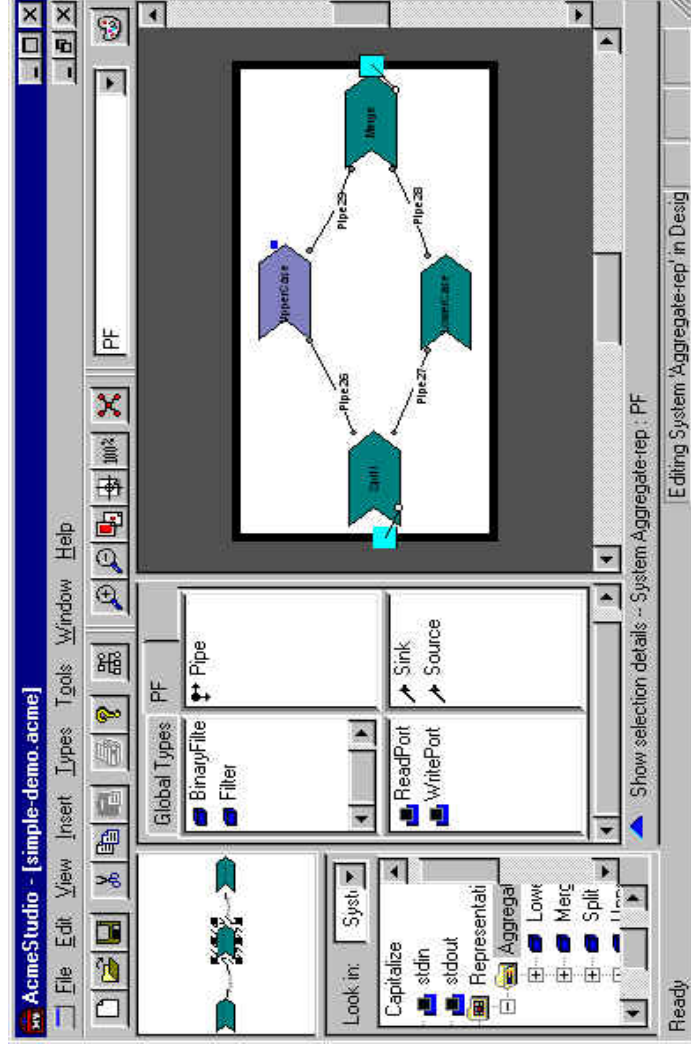

Architecture Systems as Composition Systems



Web Services and their Languages as Specific ADL

- Languages: BPEL, BPNM
- Binding procedure is interpreted, not compiled
- More flexible than binary connectors:
 - When interface changes, no recompilation and rebinding
 - Protocol-independent

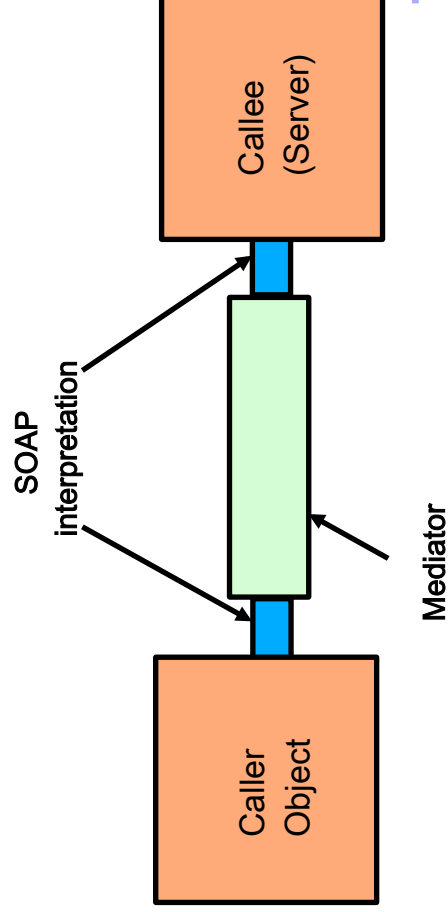

Web Services as Composition System



What the Composition Language Offers for the Software Process

- ▶ **Communication**
 - Client can understand the architecture graphics well
 - Architecture styles classify the nature of a system in simple terms (similar to design patterns)
- ▶ **Design support**
 - Refinement of architectures (stepwise design, design to several levels)
 - Visual and textual views to the software resp. the design
- ▶ **Validation: Tools for consistency of architectures**
 - Are all ports bound? Do all protocols fit?
 - Does the architecture corresponds to a certain style? Or to a model architecture?
 - Parallelism features as deadlocks, fairness, liveness,
 - Dead parts of the systems
- ▶ **Implementation: Generation of large parts of the communications and architecture**

Black-Box Composition

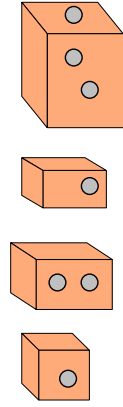

Components

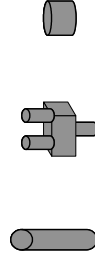

Connectors



Composition recipe

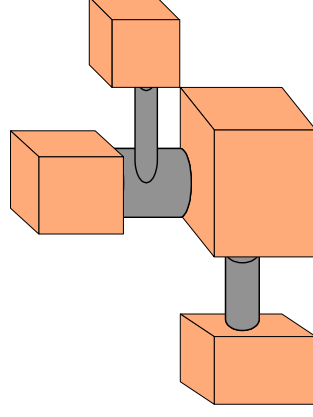

Component-based applications



The Essence of Black-Box Composition

- ▶ 3 Problems in System construction
 - Variability
 - Extensibility
 - Adaptation
- ▶ In “Design Patterns and Frameworks”, we learned about design patterns to tackle these problems
- ▶ Black-box composition supports variability and adaptation
 - not extensibility



The Ladder of Composition Systems (rev.)

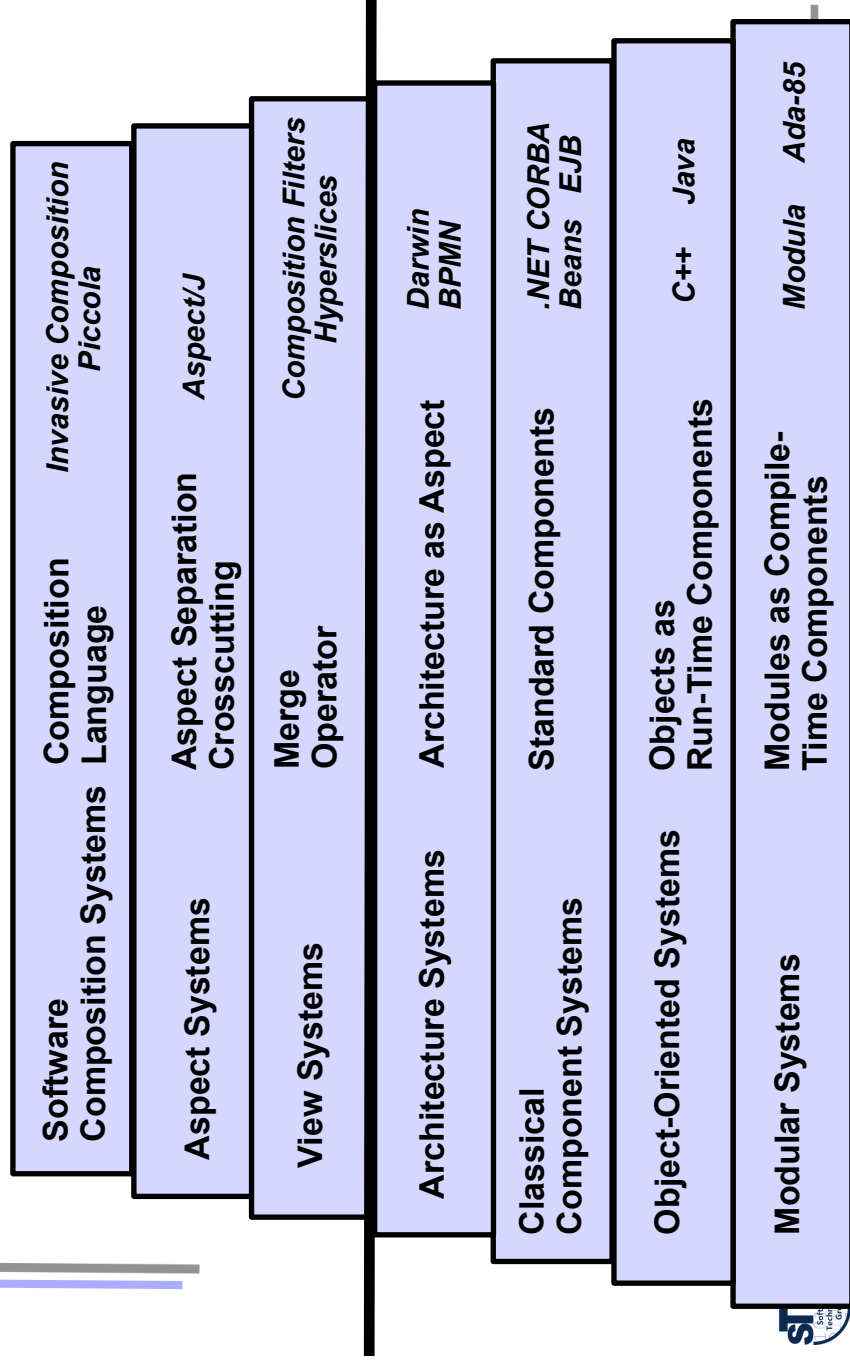

1.3 Gray-box Component Models

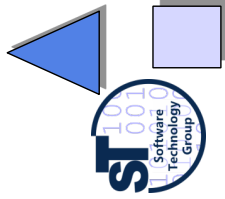



The Essence of the Last Years

- ▶ **View-based Programming**
 - ▶ Component merge (integration)
 - ▶ Component extension
- ▶ **Aspect-oriented Programming**
 - ▶ Views can cross-cut components

Gray-box composition merges design-time components to run-time components

Black-box composition leaves design-time components untouched (1:1 relationship)



Aspects in Architecture

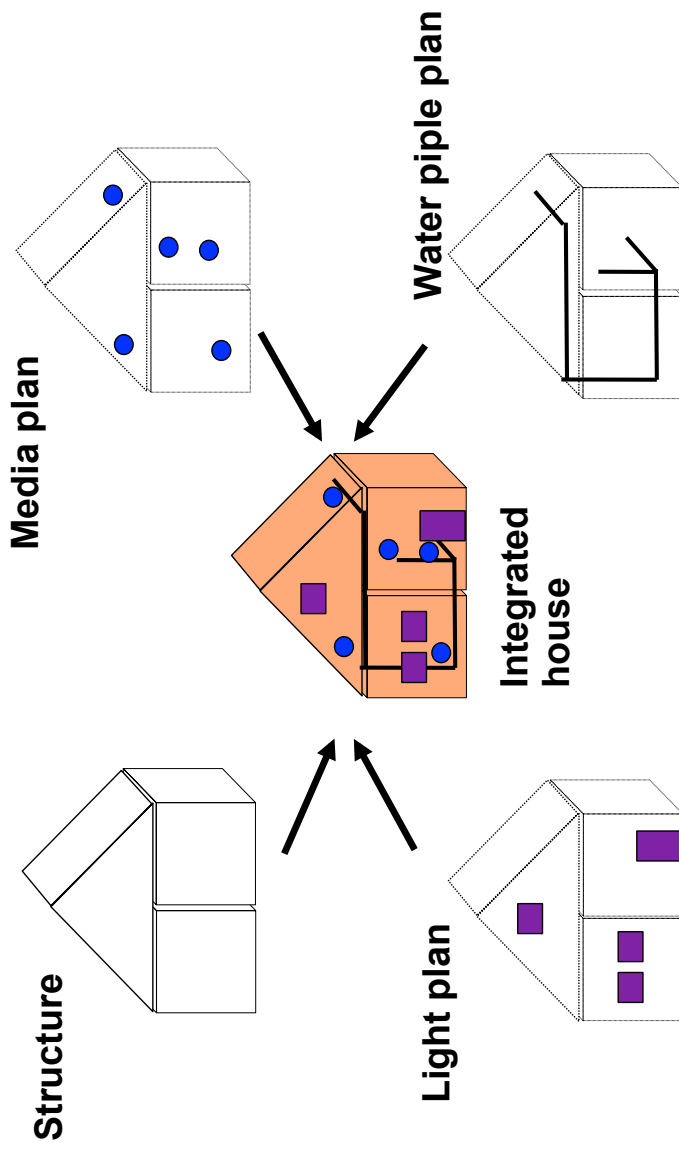

Aspects in Software

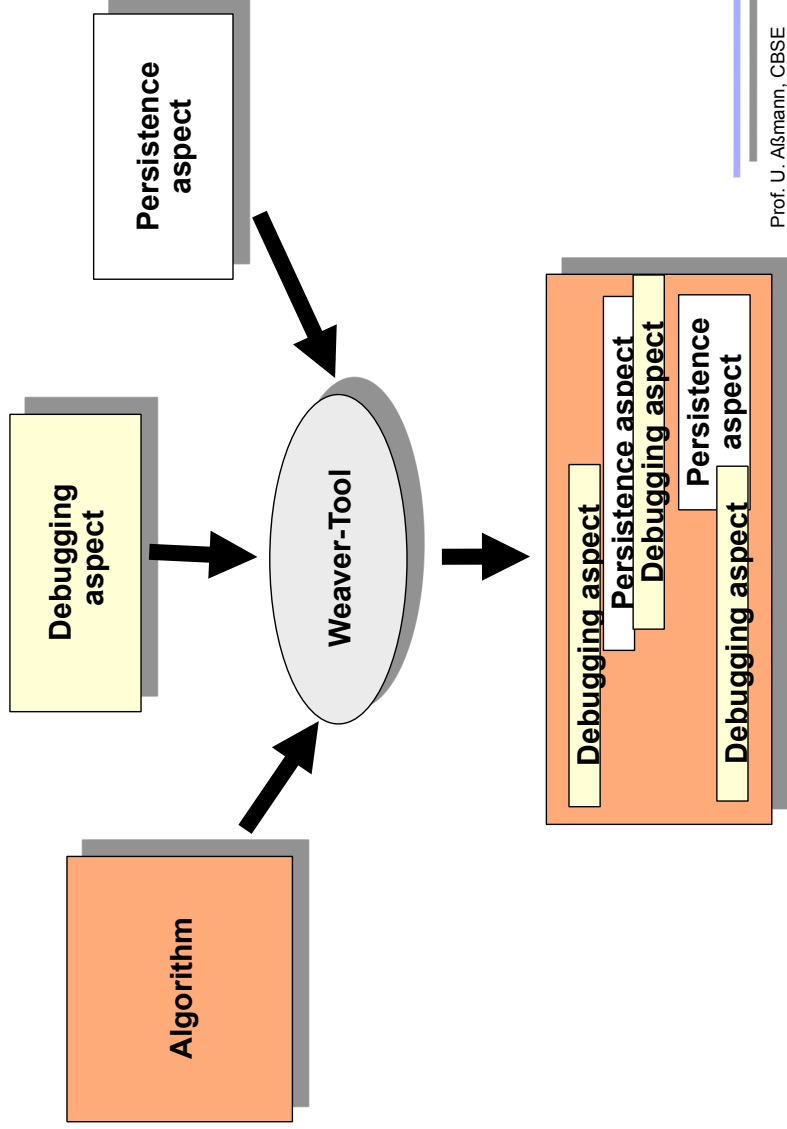

Aspect Weavers Distribute Advice Components over Core Components

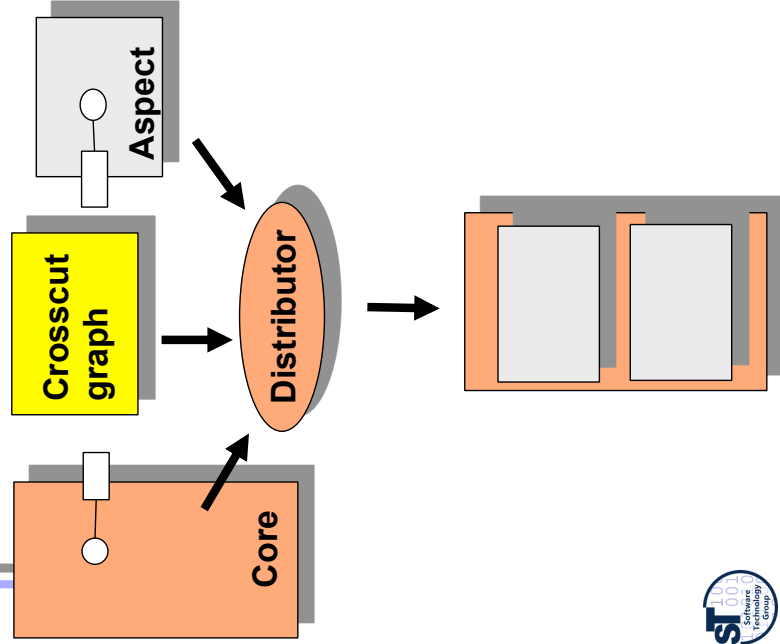

- ▶ Aspects are *crosscutting*
- ▶ Hence, aspect functionality must be *distributed* over the core
- ▶ The distribution is controlled by a crosscut graph

Aspect Systems As Composition Systems

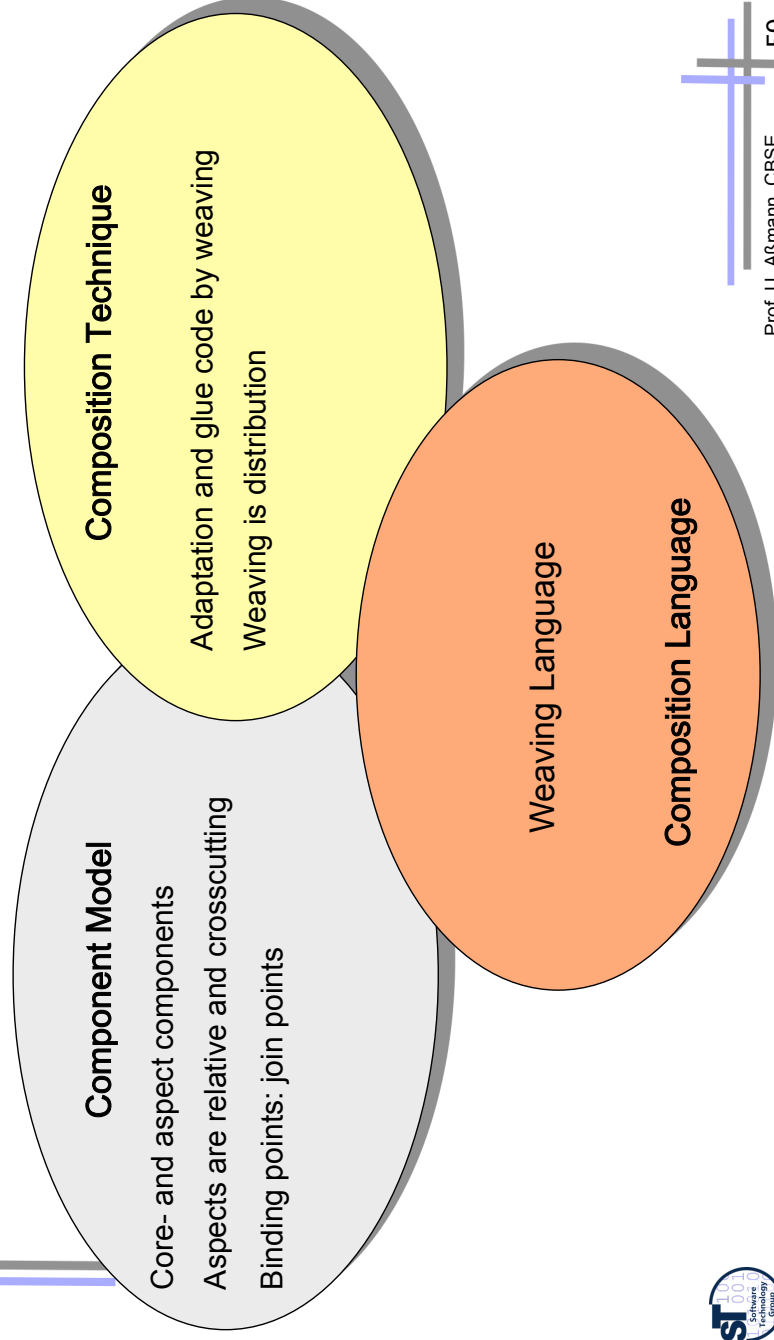

1.3.1 Full-Fledged Composition Systems

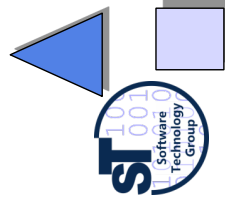

Composition Systems

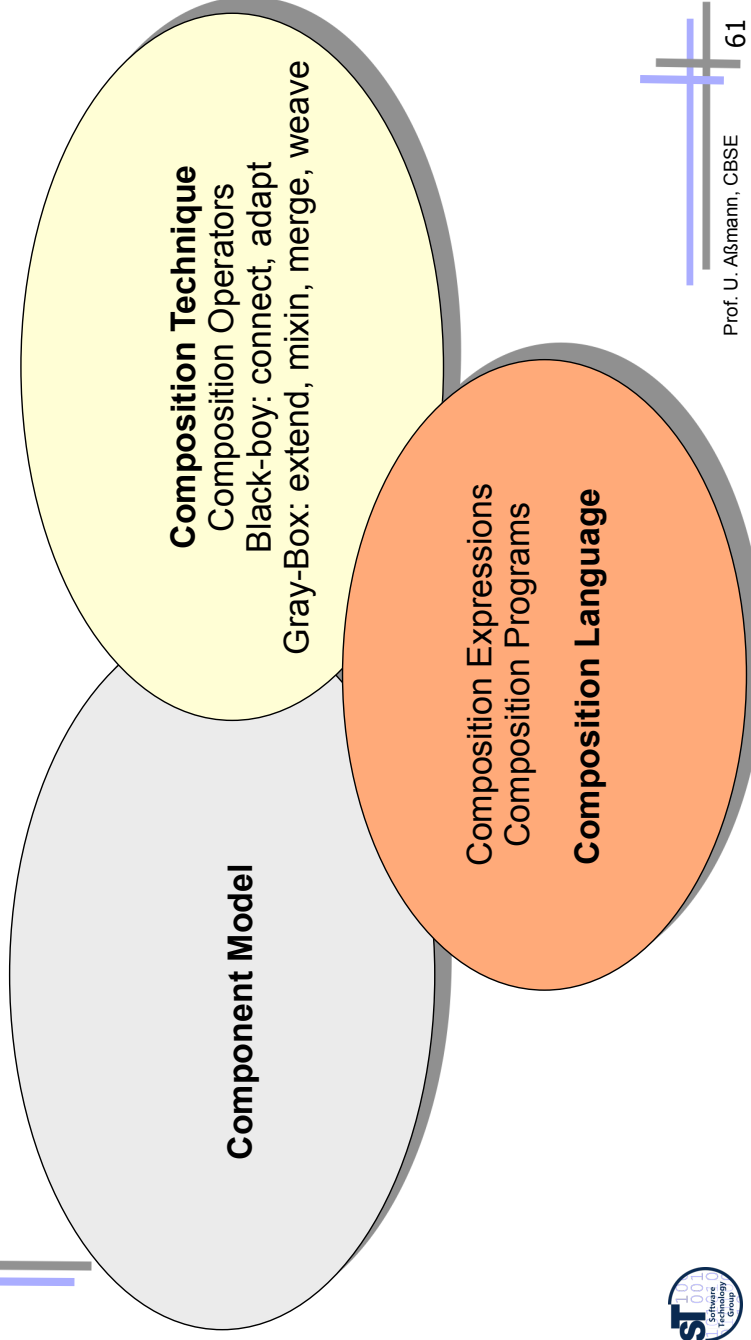

Composition Systems

- ▶ All the following composition systems support full black-box and grey-box composition, as well as full-fledged composition languages:
 - ▶ Composition filters [Aksit, Bergmans]
 - ▶ Hyperspace Programming [Ossher et al., IBM]
 - ▶ Piccola [Nierstrasz et al., Berne]
 - ▶ Invasive software composition (ISC) [Alsmann]
 - ▶ Formal calculi
 - Lambda-N calculus [Dami]
 - Lambda-F calculus [Lumpe]



Connectors are Composition Operators

Usually, connectors connect (glue) black-box components for communication

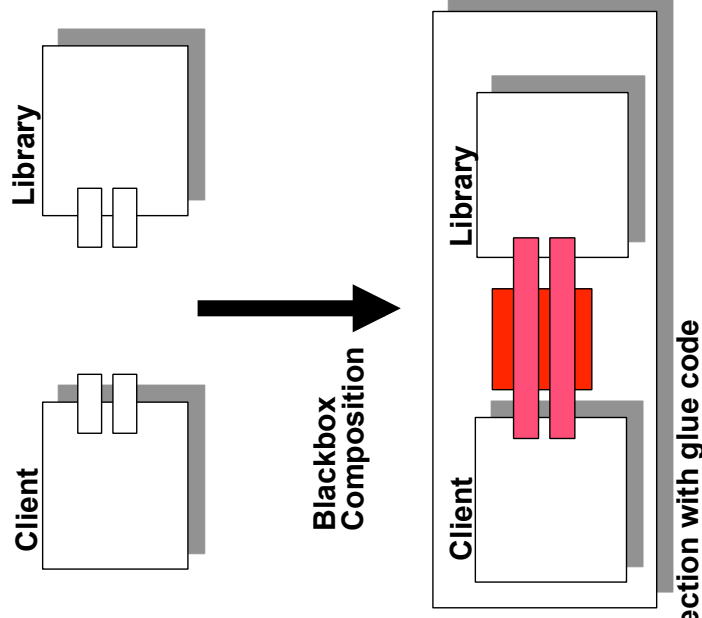

Connectors can be Grey-Box Composition Operators

Connectors can work invasively, i.e., adapt components inside

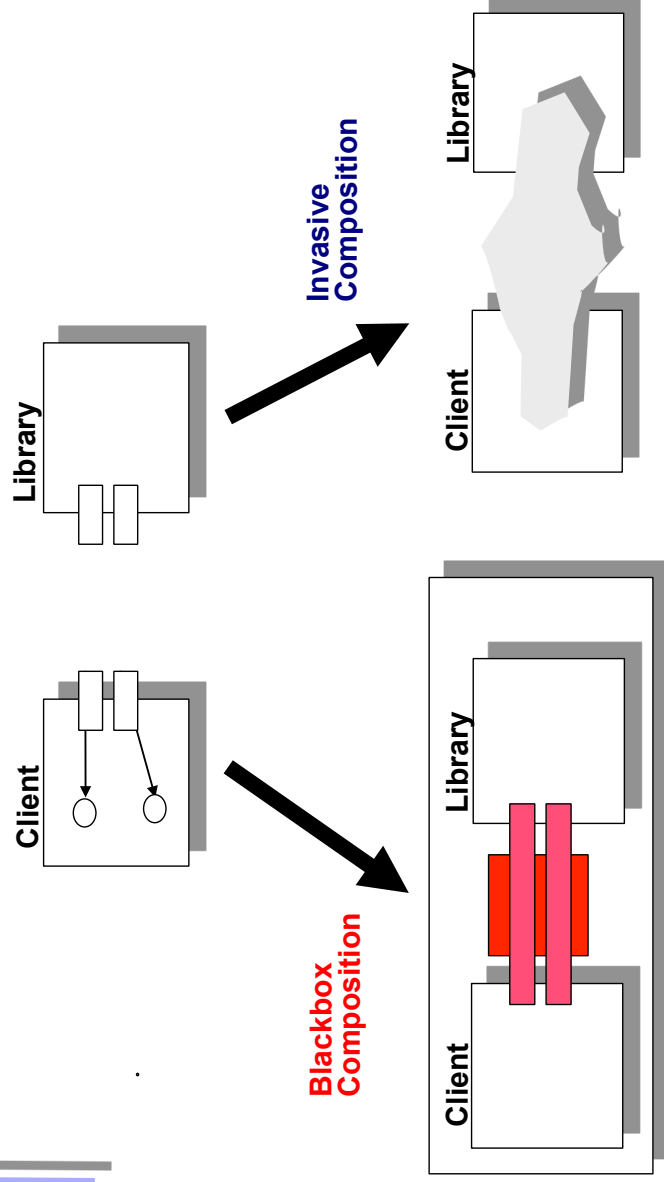

Composers Generalize Connectors (ADL Component Model)

Components	Composers	Variation points
Black-Box Components	Connectors, Invasive connectors Encapsulation operators	Ports

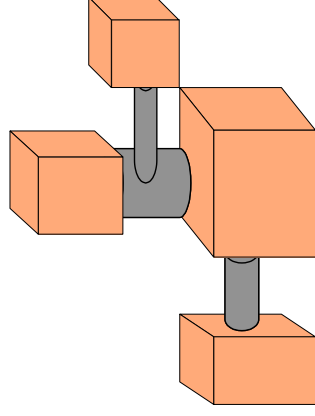

Composers Can Be Used For Inheritance

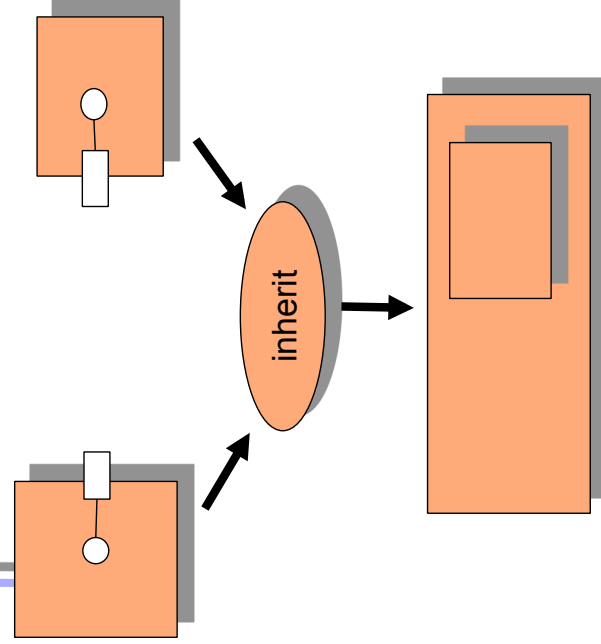

- ▶ Extension can be used for inheritance (mixins)
- ▶ inheritance :=
 - copy first super document;
 - extend with second super document;
- Be aware: The composition system of object-oriented frameworks (course DPF) is only one of the possible ones

Composers Generalize Inheritance Operators (Classes as Components)

Components	Composers	Extension points
Classes	Mixin operators, inheritance operators	Class member lists

Composers Generalize View-based Extensions

- ▶ **Symmetric view:** Two components are merged
- ▶ **Asymmetric view:** A core component is extended by a view component

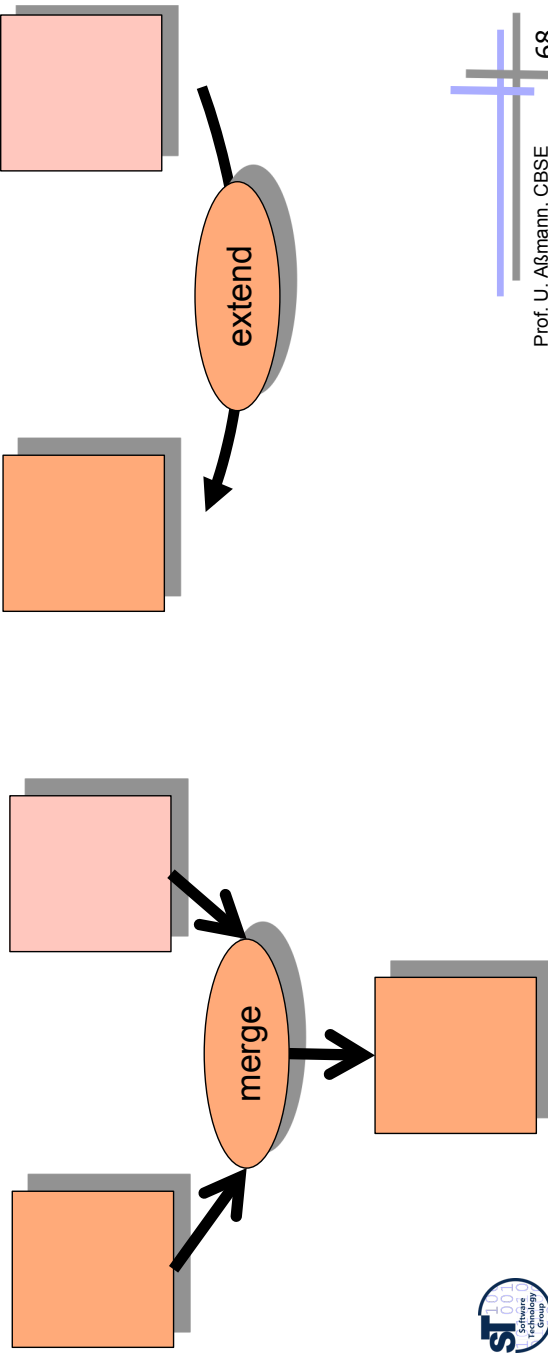

Composers Generalize View Extensions

Components	Composers	Extension points
Views	Merge operators, extend operators	Open definitions

Composers Generalize Aspect Weavers

- ▶ Complex composers *distribute* aspect fragments over core fragments
- ▶ *Distributors* extend the core
 - Distributors are more complex operators, defined from basic ones
 - Distribution is steered by a *crosscut graph*

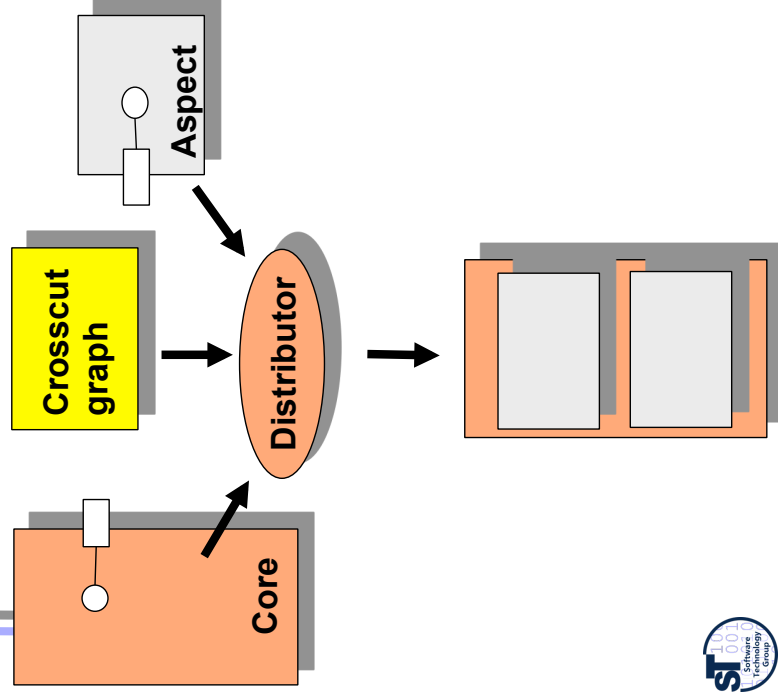

Weavers Are Complex Distributors

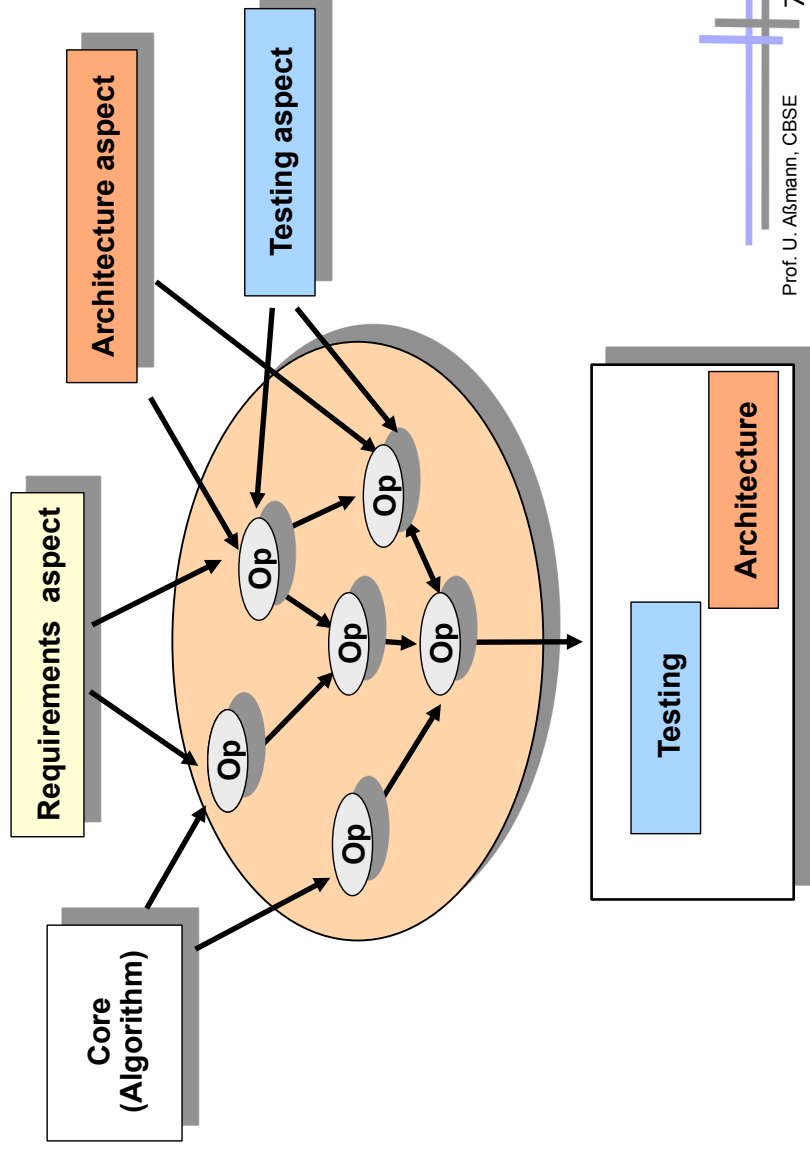

Composers Generalize Aspect Weavers

Components	Composers	Extension points
Core, advice groups	Weaver	Join points

Comparison Table

Approach	Components	Composers	Variation/ Extension points
Modular systems	Modules	Static linking Dynamic linking	Linker symbols
Object-oriented systems	Classes	Mixin inheritance operator, mixin layer operator, other inheritance operators	Class member lists
Architecture systems	Objects	Polymorphic dispatch Dynamic invocation Tracing	
Generic systems	Black-Box Components	Connectors, Invasive connectors Encapsulation operators	Ports
View systems	Generic Fragments	Binding	Slots
Aspect systems	Views (fragments)	Merge operators, extend operators	Open definitions
Full composition systems	Core, advice groups All of the above	Weaver Explicit crosscut specifications	Join points Slots and join points



Composition Languages in Composition Systems

- ▶ Composition languages describe the structure of the system in-the-large (“programming in the large”)
 - ▶ Composition programs combine the basic composition operations of the composition language
- ▶ Composition languages can look quite different
 - ▶ Imperative or rule-based
 - Textual languages
 - Standard languages, such as Java
 - Domain-specific languages (DSL) such as Makefiles or ant-files
 - Graphic languages
 - Architectural description languages (ADL)
- ▶ Composition languages enable us to describe large systems

Composition program size 1

System size 10





Conclusions for Composition Systems

- ▶ Components have *composition interface* with variation and extension points
 - Composition interface is different from functional interface
 - The composition is running usually *before* the execution of the system
 - From the composition interface, the functional interface is derived
- ▶ System composition becomes a new step in system build



Steps in System Construction

- ▶ We need component models and composition systems on all levels of system construction

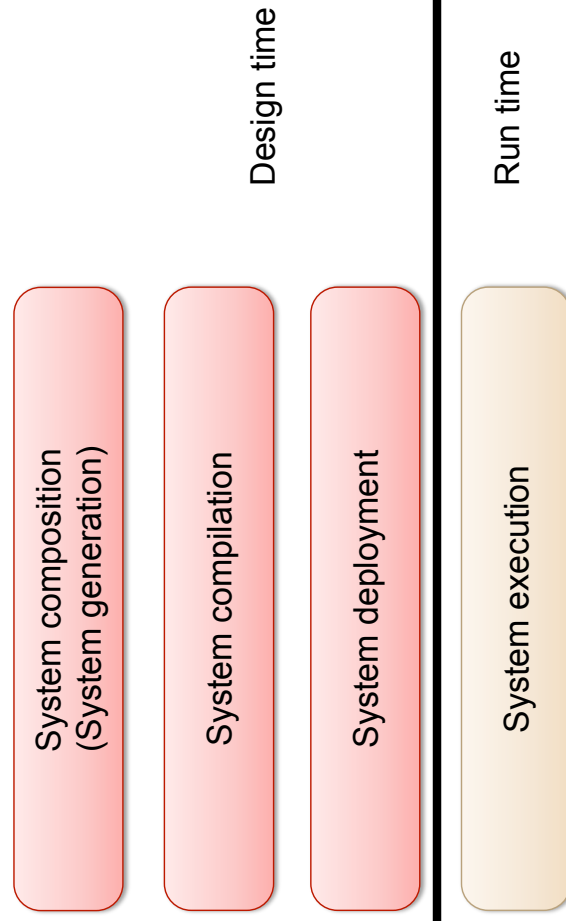

1.4 What Have We Learned?

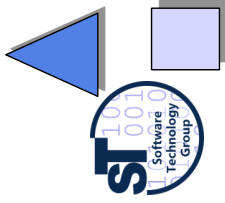

CBSE, © Prof. Uwe Alsmann

77

Component-based Systems

- ▶ ... are produced by component systems or composition systems
- ▶ ... have a central relationship that is tree-like or reducible
- ▶ ... support a component model
- ▶ ... allow for component composition with composition operators
 - ... and – in the large – with composition languages
- ▶ Historically, component models and composition techniques have been pretty different
 - from compile time to run time
- ▶ Blackbox composition supports variability and glueing
- ▶ Graybox composition supports extensibility, views, aspects
- ▶ Object-orientation is just one of the many composition systems which have been defined



The Ladder of Composition Systems

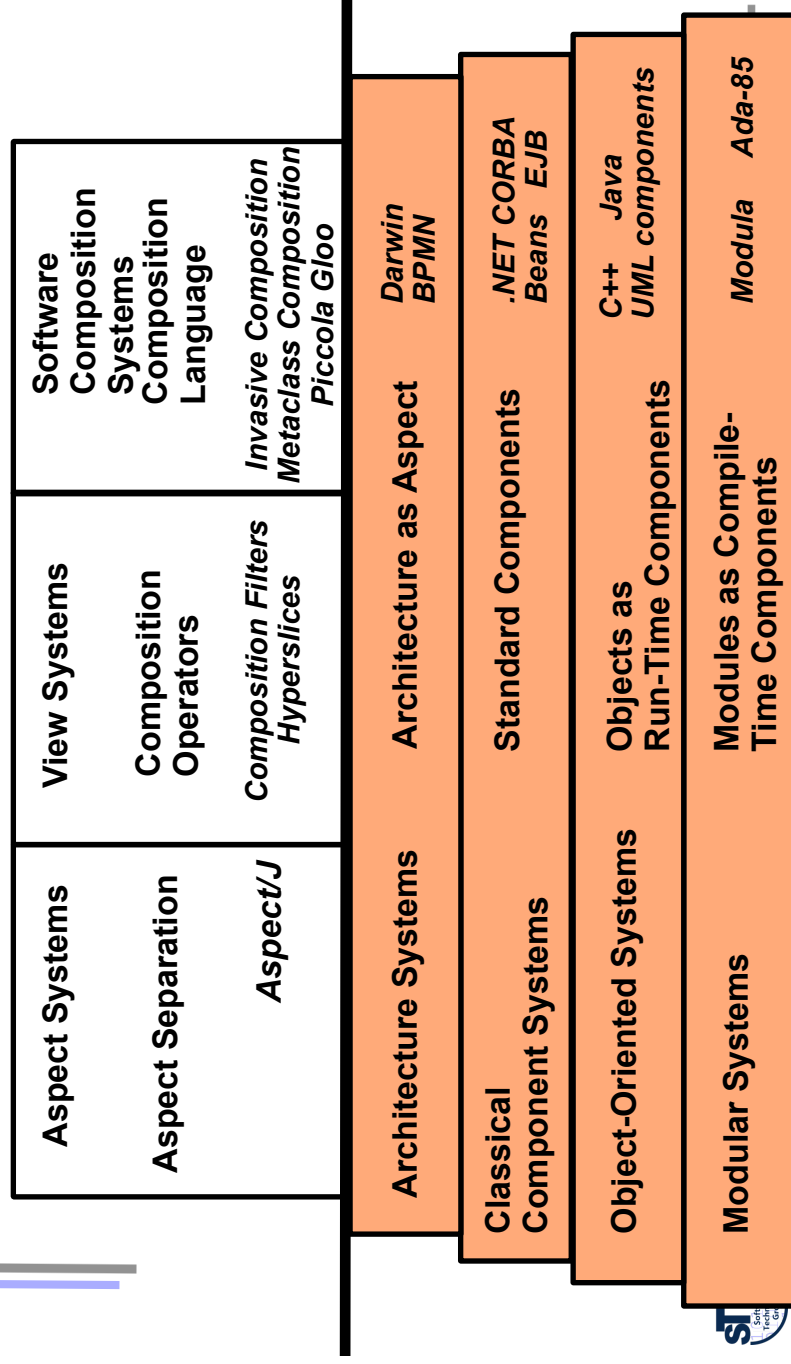

The Ladder of Composition Systems

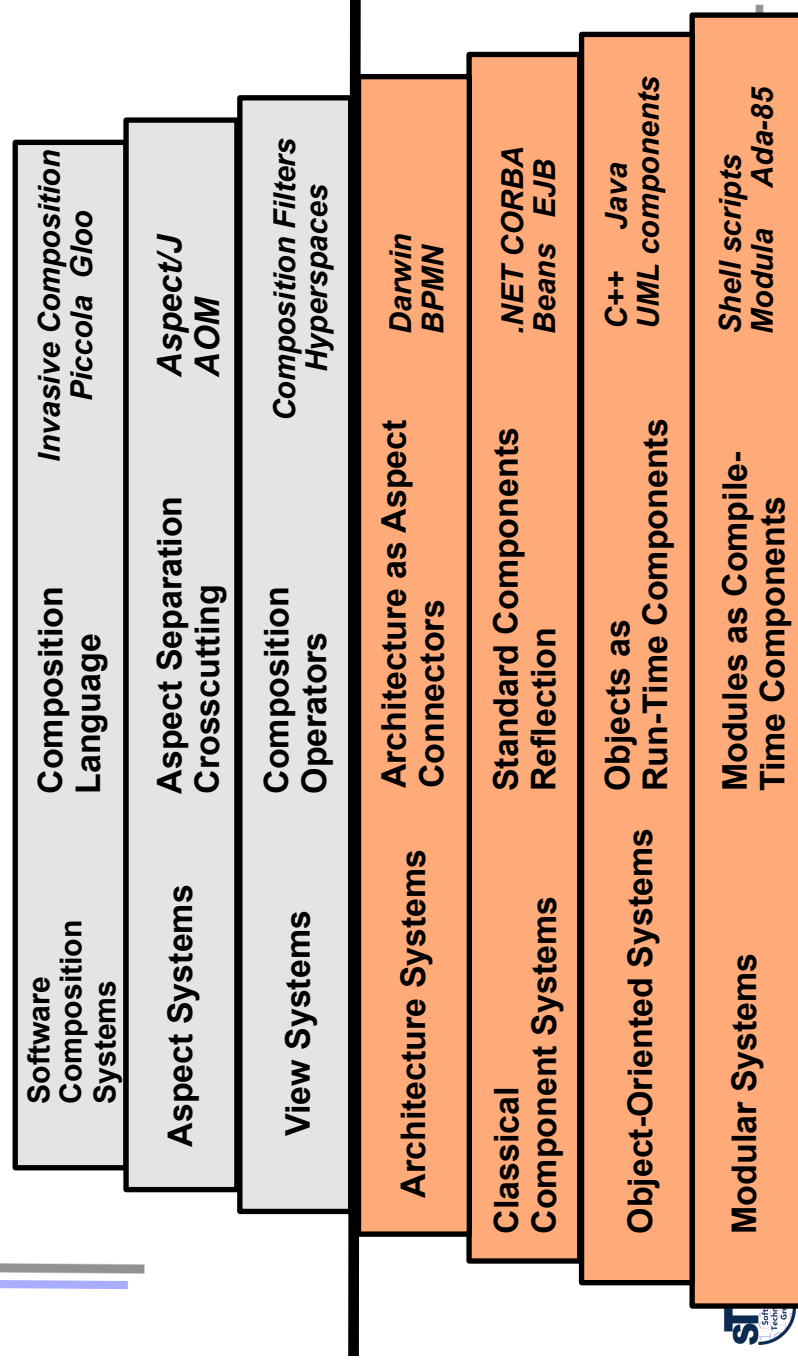

What Can Be Done with Composition Systems?

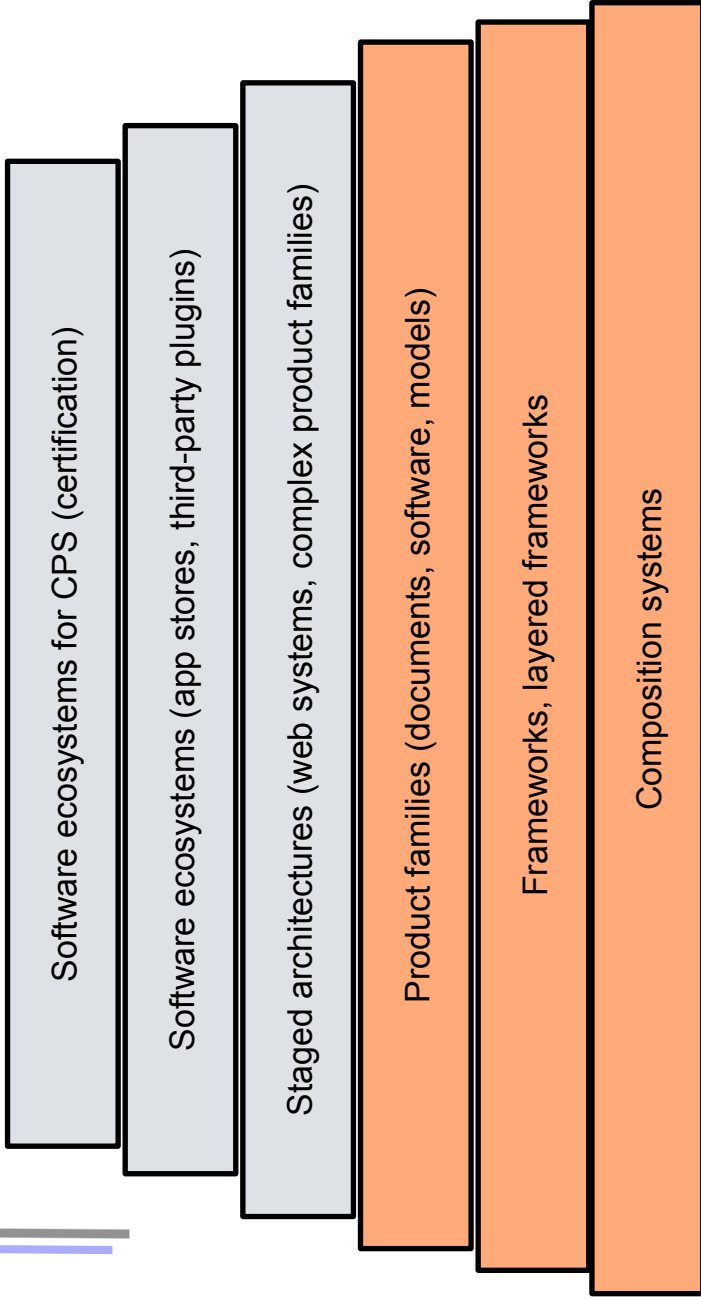

The End

