

41) Transconsistent Composition for Active Documents and Component-Based Document Engineering (CBDE)

Prof. Dr. Uwe Aßmann
Florian Heidenreich

Technische Universität Dresden
Institut für Software- und
Multimediatechnik

<http://st.inf.tu-dresden.de>

Version 11-0.1, Juli 5, 2012

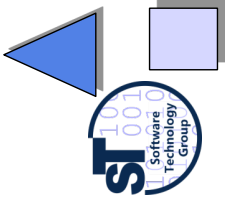

1. Problems of Document Composition
2. Invasive Document Composition
3. Invasive Architectures for Active Documents
4. Transconsistency
 1. A Graph-Theoretic Definition of Transconsistency
 2. Transconsistent Architectures
5. Architectural Styles for Transconsistent Architectures

CBSE, © Prof. Uwe Aßmann

1

Literature

- ▶ U. Aßmann. Architectural Styles for Active Documents.
<http://dx.doi.org/10.1016/j.scico.2004.11.006>



Overview

- ▶ Some problems in document processing
 - And why they require document architecture
- ▶ Invasive composition of active documents
- ▶ Export declarations as a basis for architecture of active documents
- ▶ Features of acyclic, interactive architectures
 - Transconsistency, a novel evaluation concept for composition programs for active documents
 - Transconsistent architectural styles for active documents
- ▶ Conclusions for web engineering



Architecture and Composition

- ▶ One of the central insights of the software engineering in the 1990s is:
 - Separate architecture (composition) from the base components
- ▶ Purpose: Get a second level of variability
 - Architecture and components can be varied independently of each other
 - Scale better by different binding times of composition programs
 - Be *uniform* for many products of a product family
- ▶ However, how to be uniform also for documents?



41.1) Problems in Document Construction

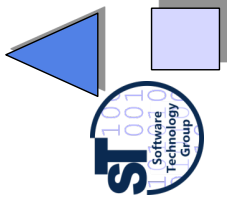

CBSE, © Prof. Uwe Alsmann

5

Some Problems 1 – `\cite` in `LaTeX`

- ▶ As already McIlroy.68 has shown, we need components for a ripe industry

```
@InProceedings{ mcilroy.68b,  
  author = "M. Douglas McIlroy",  
  title = "Mass-Produced Software Components",  
  booktitl = "Software Engineering Concepts and Techniques (1968 {NATO}  
             Conference of {S}oftware Engineering)",  
  editor = "J. M. Buxton and Peter Naur and Brian Randell",  
  publisher = {NATO Science Committee},  
  pages = "88--98",  
  month = oct,  
  year = "1968"  
}
```



Usual Solution

- ▶ Problem: Document is *active*, i.e., contains generated components
- ▶ Procedure:
 - Latex writes citation to .aux-file
 - bibtex greps them and produces a .bbl file
 - .bbl file is included into document
- ▶ How does the architecture of a latex document look like that regenerates all generated components?



Maybe Like This...

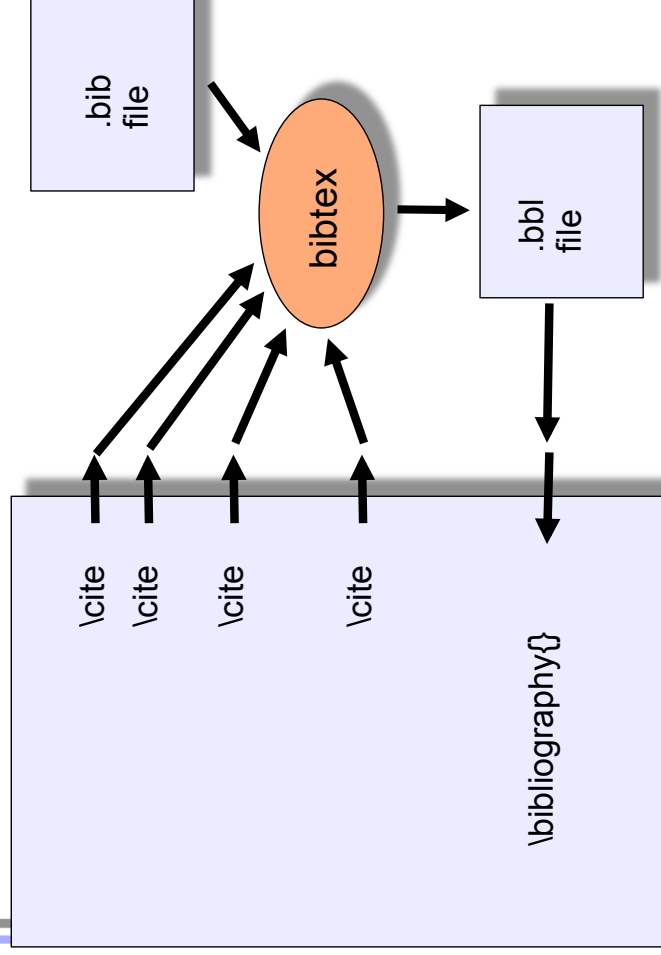

Problem 2 – Deliverable Definitions in LaTeX Project Plan

```
\begin{deliverables}
EASYCOMP workshop I      &DIS.1.1 & \UKA & 12 & W & PU & 18 \\\
EASYCOMP workshop II    &DIS.1.2 & \UKA & 12 & W & PU & 30 \\\
Web-based Composition Centre &DIS.2 & \UKA & 3 & H & PU & 36 \\\
Composition Handbook    &DIS.3 & \UKA & 14 & R & PU & 24 \\\
Final Report            &DIS.4 & \UKA & 6.5 & R & CO/PU & 36 \\\
\end{deliverables}
```

- ▶ Procedure:
 - extract deliverables by perl script
 - concat to latex table
 - include table

- ▶ How does the architecture of that document look like?

Like This...

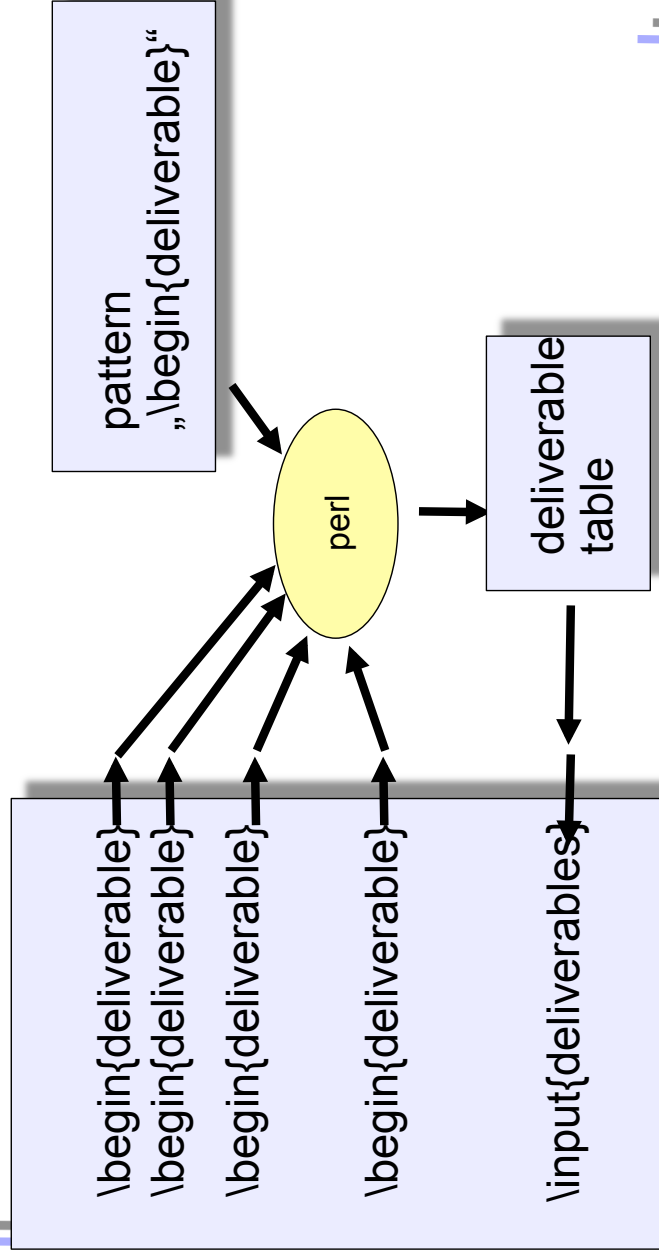

Query Should Use the AST/ASM

- ▶ Regular expressions are too weak

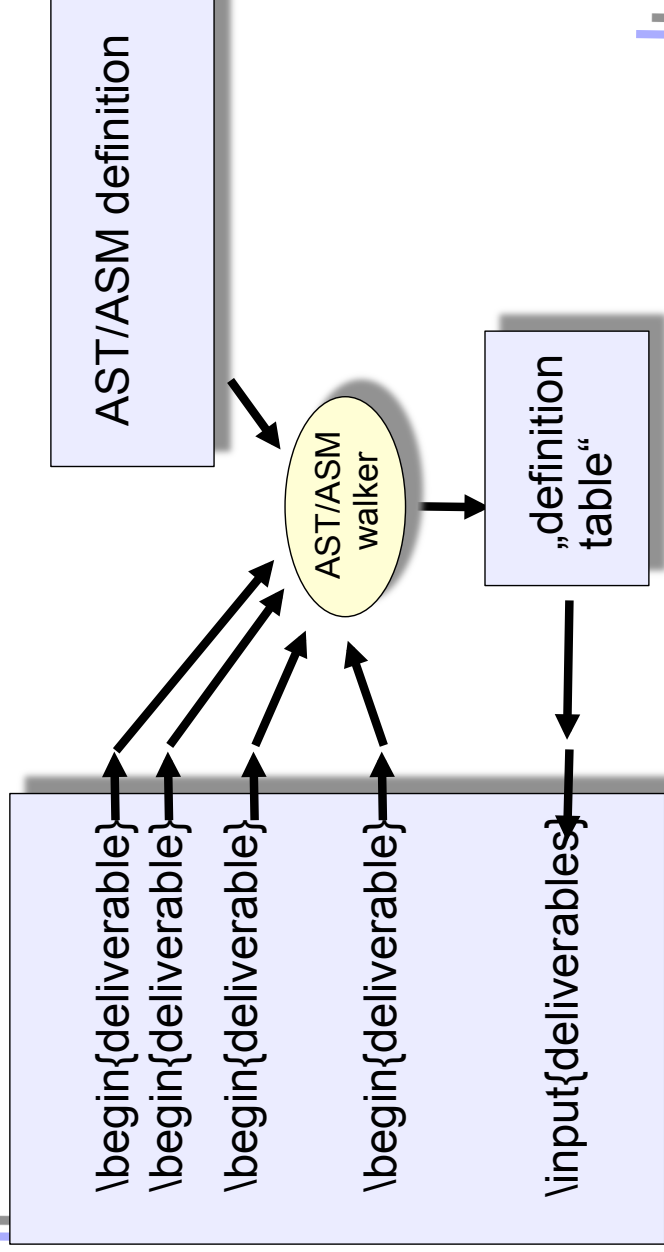

Problem 3 – A Simple Web Page, Generated By a Database

```
<html>
..
<table>
<tr> <td> Employee </td> <td> Address </td> </tr>
<tr> <td> Uwe Assmann </td> <td> Farhagsvägen 128 </td> </tr>
<tr> <td> Robert Kaminski </td> <td> Platensgatan 9 </td> </tr>
<tr> <td> Jens Gustavsson </td> <td> Stora Torget 14 </td> </tr>
</table>
..
</html>
```

- ▶ Procedure:
 - Run the embedded script of an HTML template
 - Start SQL query in MySQL
 - Transform (with XSLT) the plain text to HTML
 - Include table and replace the embedded script

- ▶ How does the architecture of that document look like?

Like This....

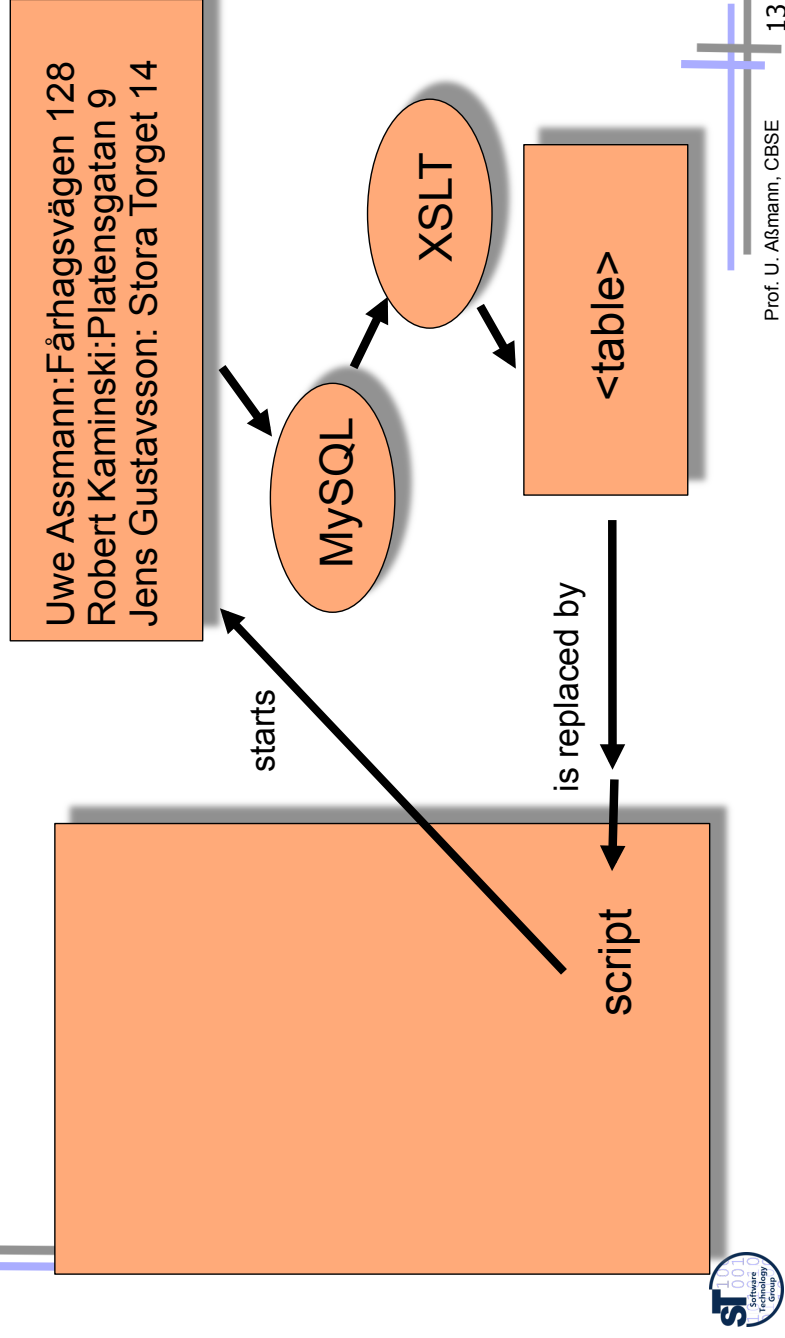

Problem 4: Electra Spreadsheet

- ▶ Used for contract negotiations about project budgets with the EC
- ▶ About 10 summary pages, generated from participant figures
- ▶ 4 pages per participant
- ▶ No architecture available....



Conclusion

- ▶ Why don't we define document architectures?
 - That allows for extracting the architecture and separating it from „components“
- ▶ Software architecture and composition have been successful for
 - Developing in the large
 - Software reuse
- ▶ Why don't we define a *document architecture language*?
 - That allows for expressing the coarse grain structure of documents?
 - And unify it with software architecture / software composition?



But An Architectural Language For Documents is Difficult..

- ▶ Well, connectors as binding elements between components don't suffice
 - It must be composition operations or other mechanisms (such as AG) that glue the components together
 - We need composition languages for uniform composition
- ▶ There are some other problems...
 - Invasiveness
 - Transconsistency

41.2) Invasive Composition of Active Documents

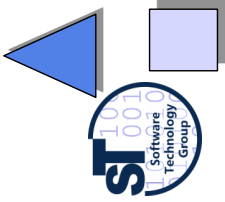

CBSE, © Prof. Uwe Alsmann

17

The Elements of Composition

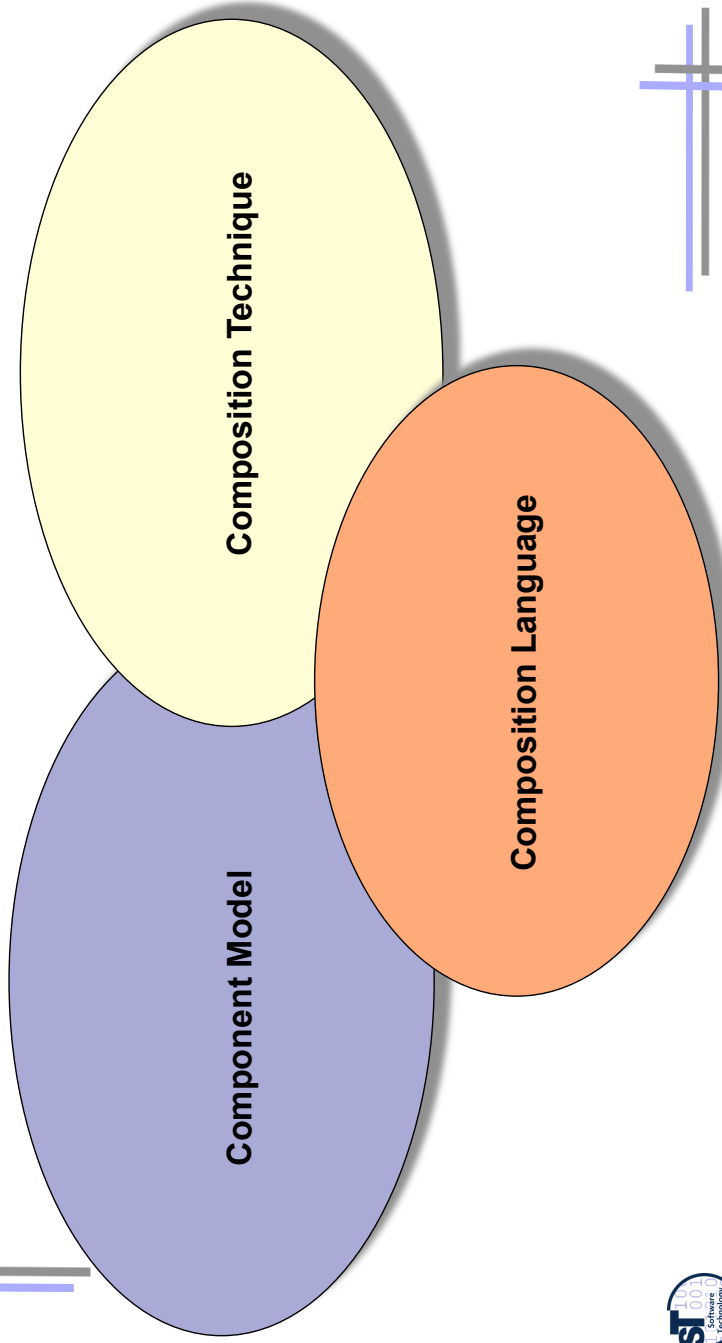

Prof. U. Alsmann, CBSE

18

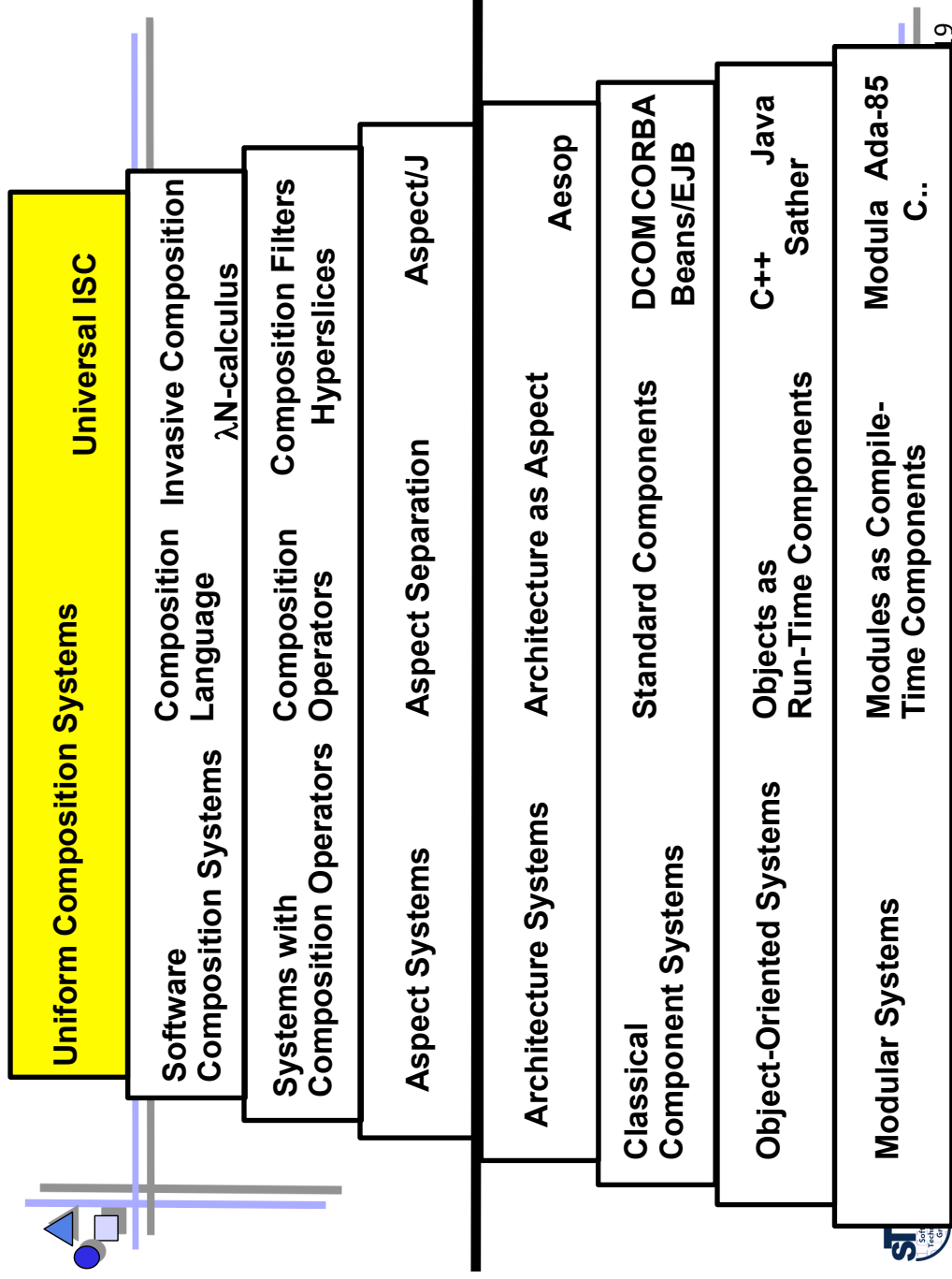

For Active Documents, We Need Invasiveness

- ▶ Active documents require invasive patching
- ▶ If some parts are changed, others need to be updated
- ▶ Question: are there invasive component models?
- ▶ Answer: yes

41.3) Invasive XML Composition

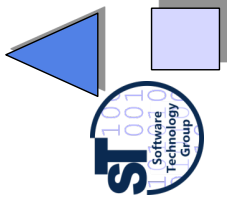

CBSE, © Prof. Uwe Alsmann

21

A Greybox Component Model For Uniform XML Composition

Invasive document composition adapts and extends document fragment components at hooks by transformation

- ▶ A document fragment component is a fragment group of a document language
 - OpenOffice XML, Word XML, AbiWord, many others
- ▶ Uniform representation for
 - Text
 - Pictures
 - Sheets

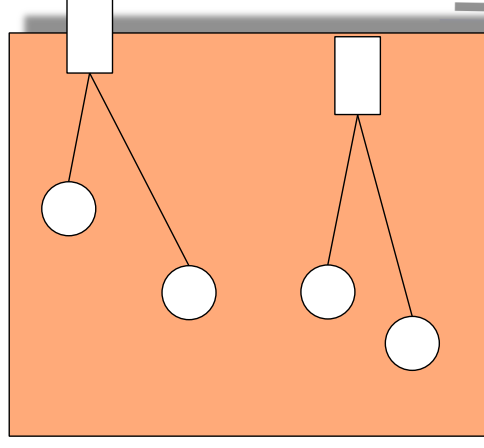

Implicit Hooks For XML

- ▶ A **hook (extension point)** is given by the document language
 - ▶ In XML given by the DTD or Xschema
- ▶ Hooks can be *implicit* or *explicit (declared)*
 - We draw implicit hooks *inside* the component, at the border
- ▶ Example List Entry/Exit

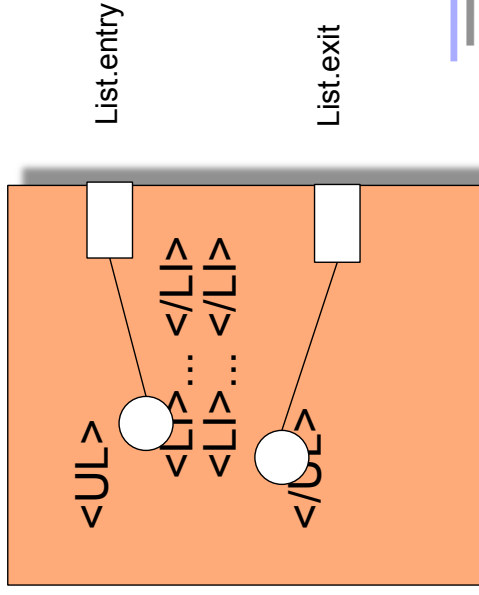

The Composition Technique of Invasive Composition

- ▶ A composer is a tag transformer from unbound to bound hooks
composer: box with hooks --> box with tags

Invasive Document Composition
parameterizes and extends
document components
at hooks
by transformation

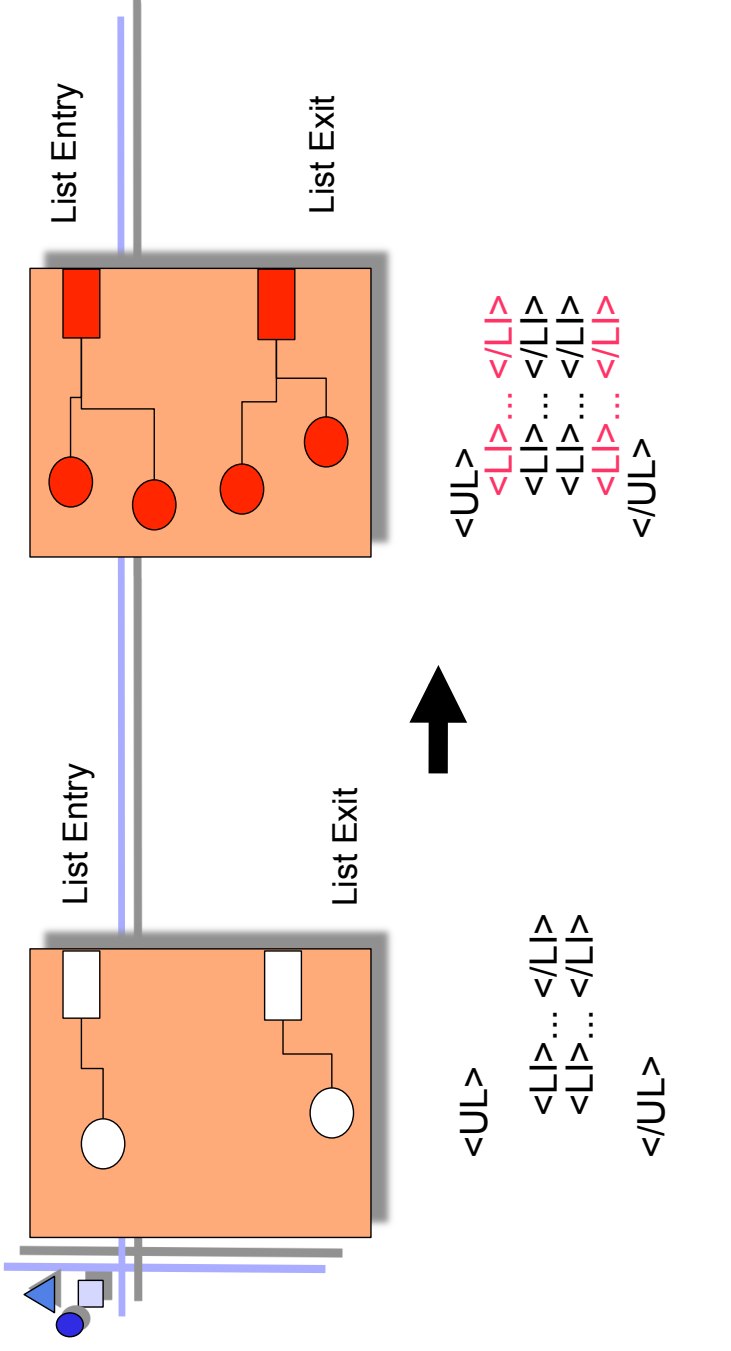

```

box.findHook(„ListEntry“).extend(„<LI>... </LI>“);
box.findHook(„ListExit“).extend(„<LI>... </LI>“);

```

Invasive XML Composition

- ▶ Invasive Composition works uniformly over code and data
- ▶ Allows to compose XML documents uniformly
- ▶ Extend operation implements what we need for document architectures

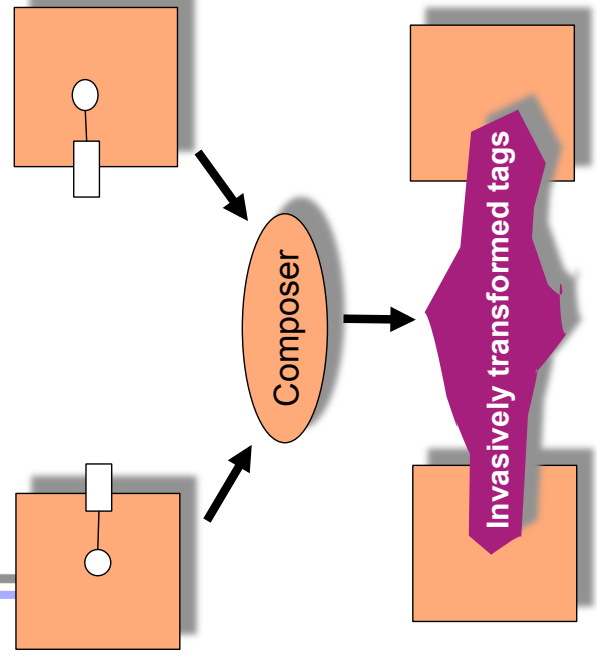



Basic Operations on XML Hooks

- ▶ bind (parameterize)
- ▶ extend
- ▶ rename
- ▶ copy



41.3 Extraction Operators

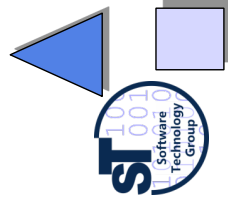



Documents Must be Decomposed

- ▶ For architecture of active documents, we need *fragment composition* and *decomposition*
- ▶ For fragment-based composition of documents, other documents need to be decomposed
- Fragment extraction with an extraction operator
 - Fragment selection or query
 - Fragment component search
 - A *fragment query language* is needed
- ▶ In the simplest case, components export all fragments (white-box)
 - Visibility can be controlled by *fragment export languages* forming export interfaces



Fragment Query Languages

- ▶ A *exported fragment* (provided fragment) is defined by a component of an active document and exposes to the external world
- ▶ The programmer declares the exported item in
 - a *fragment export language*
 - a markup language (explicit definition, embedded)
 - Often the explicit specification of exports of fragments is too cumbersome
 - a *fragment query language*
 - a extract language (implicit definition, embedded), to select fragments from a component
 - a query language (implicit definition, embedded)
 - a position addressing language (implicit, embedded)
- ▶ In whitebox reuse, fragment export and query language coincide



Extract Operator with Query Language 1

- ▶ Basic Operation to Extract Fragments:
- ▶ Extract: `ExprInQueryLanguage` → `ExportedDefinitions`

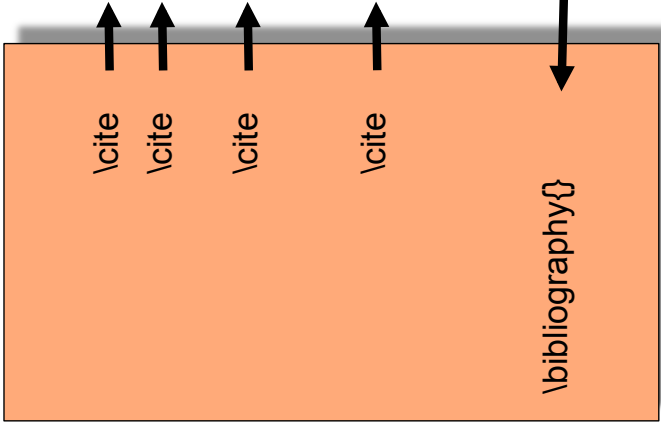

Example 1:
Query language
Regular expressions like
`\cite{.+}`

Extract Operator with Query Language 2

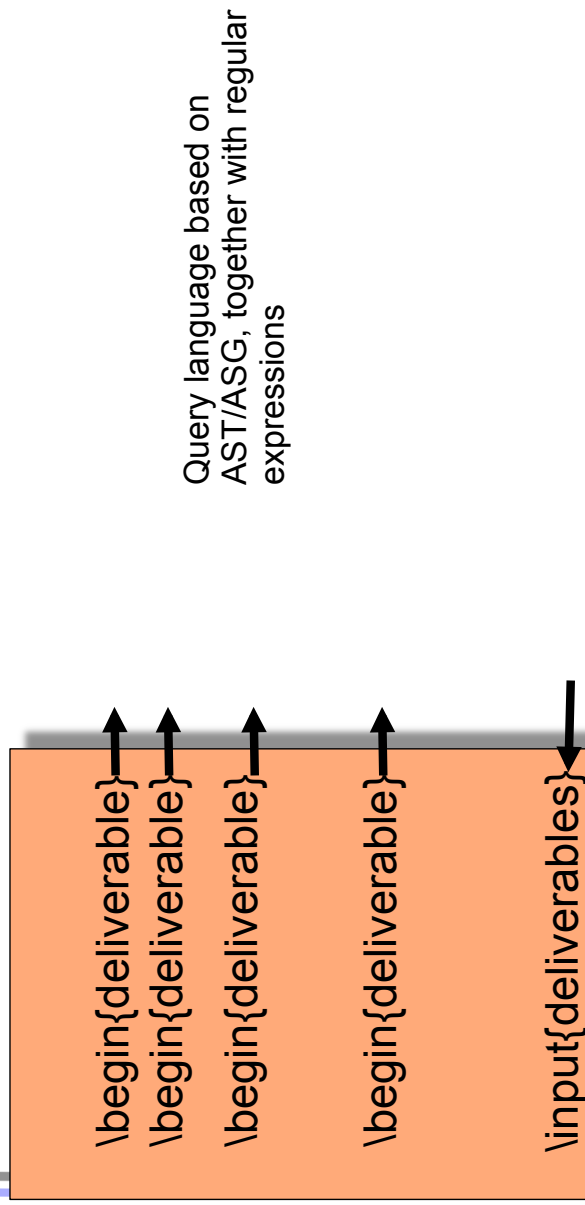

Query language based on
AST/ASG, together with regular
expressions

Extract Operator with Query Language 3

Uwe Assmann:Fårhagsvägen 128
Robert Kaminski:Platensgatan 9
Jens Gustavsson: Stora Torget 14

Query language:
Relational algebra,
started by script

Another query Language is XSLT

```
<html>
..
<table>
<tr>
<td>Employee</td>
<td>Address</td>
</tr>
<tr>
<td>Uwe Assmann</td>
<td>Fårhagsvägen 128</td>
</tr>
<tr>
<td>Robert Kaminski</td>
<td>Platensgatan 9</td>
</tr>
</table>
</html>
```

XSLT

Basic Operations on Hooks of Active Documents

- ▶ bind (parameterize)
- ▶ extend
- ▶ rename
- ▶ copy
- ▶ extract



41.3 Explicit Invasive Architectures for Active Documents

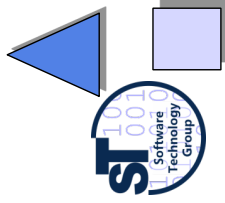

The Architecture of Case 1 `\cite` in LaTeX

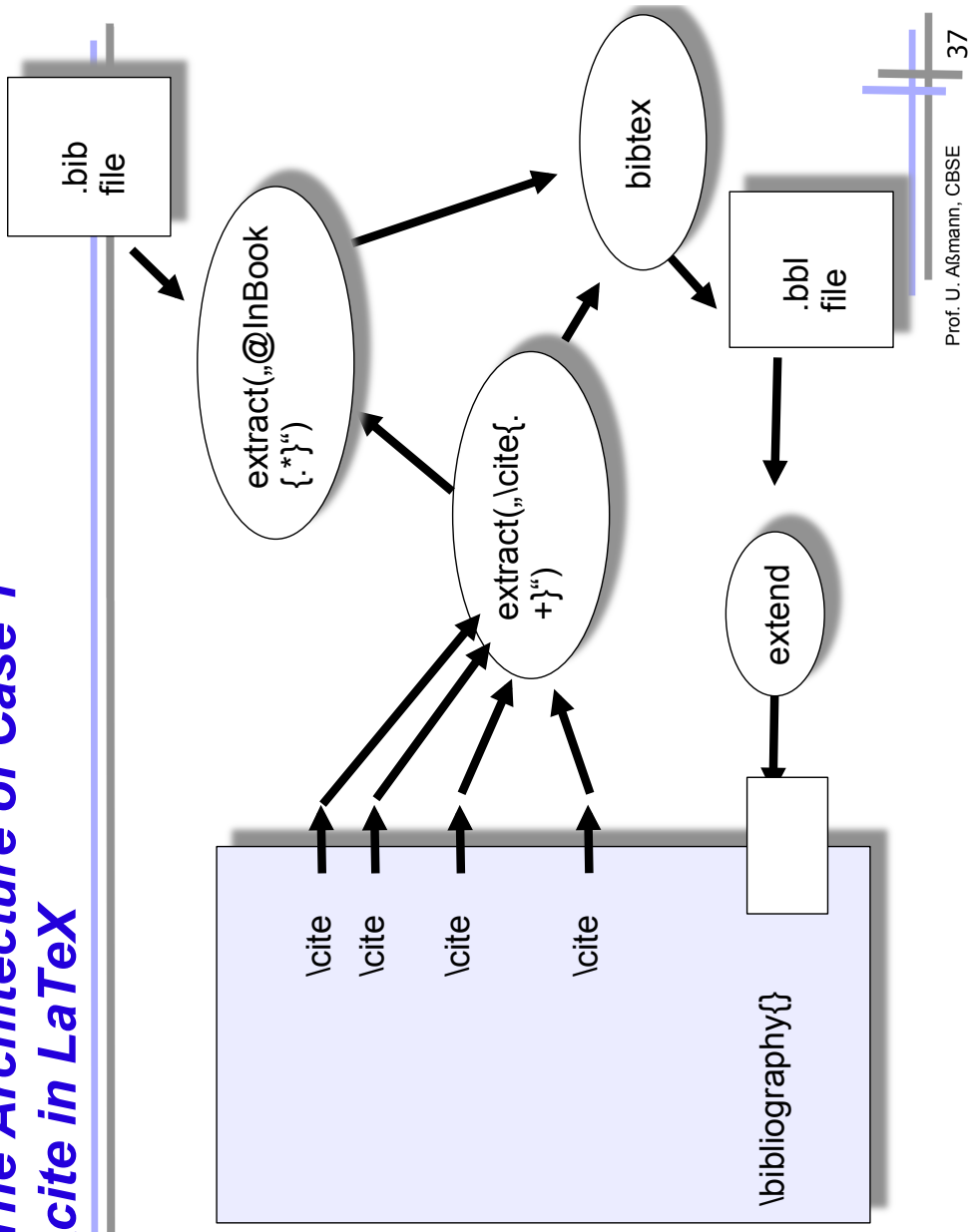

The Architecture of Case 1 With Multiple Components

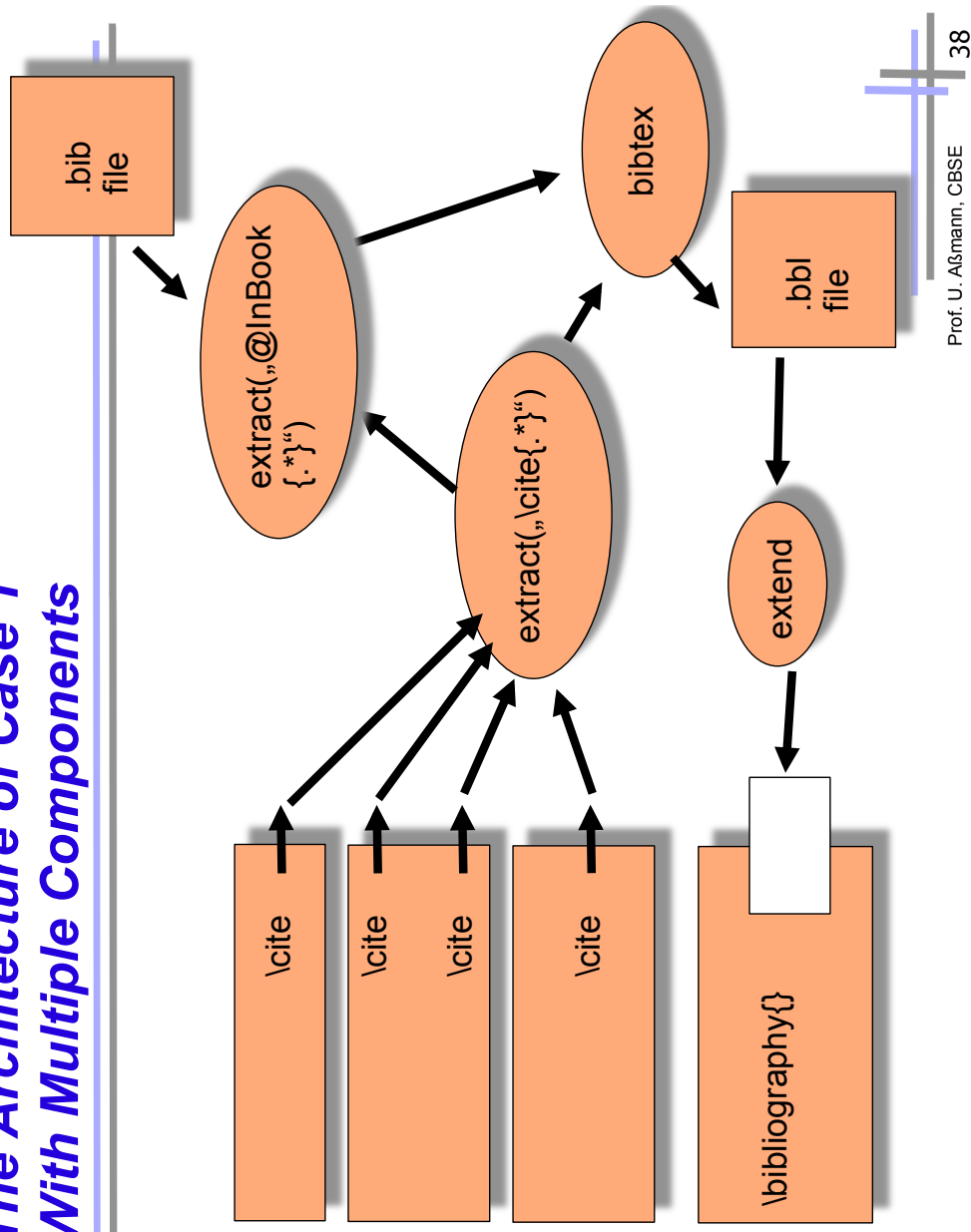

Advantages of Export Declarations For Example 1

- ▶ We have extracted the document's architecture
- ▶ LaTeX becomes simpler
 - query is separated into the composition level
- ▶ Standard language to write the compositions
 - no architectural language required
- ▶ Documents are real components, with a composition interface

The Architecture of Case 2 Deliverables

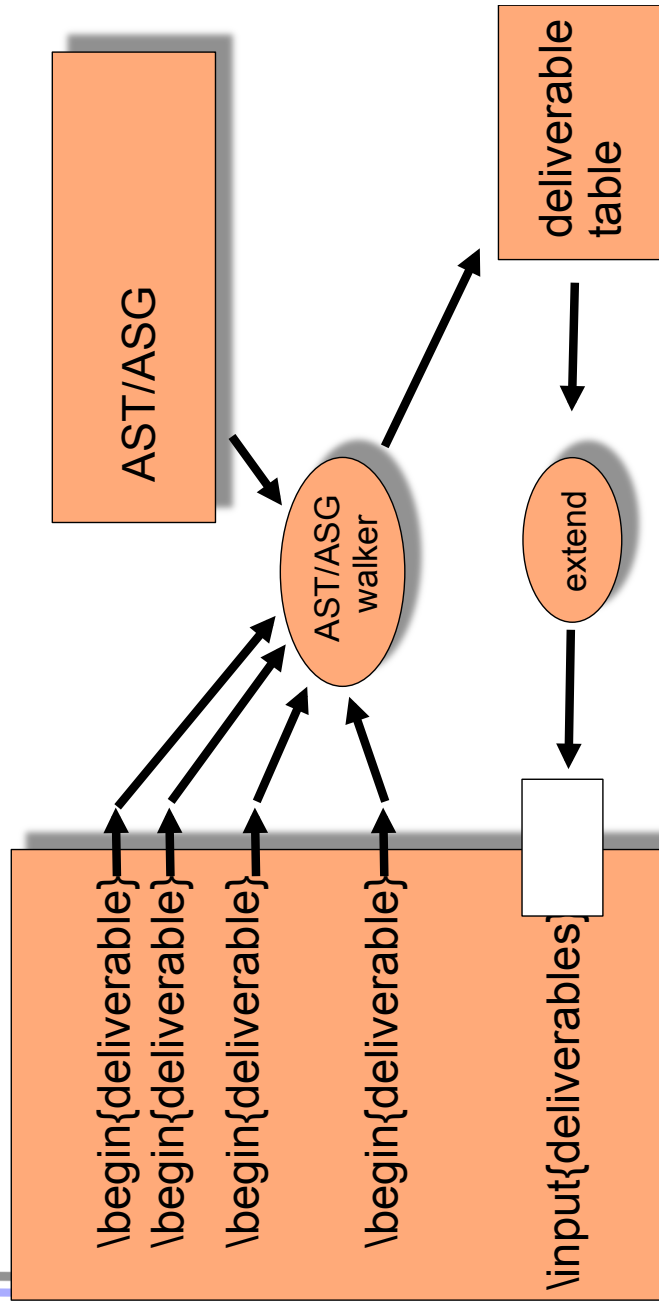

Advantages for Example 2

- ▶ LaTeX cannot interpret the AST
 - and cannot treat relational algebra either
- ▶ We can employ many different definition (query, markup) languages
- ▶ We can employ many different connection and composition languages
 - and write connectors with them
- ▶ Flexible composition approach

The Architecture of Case 3 Database-driven Web Document

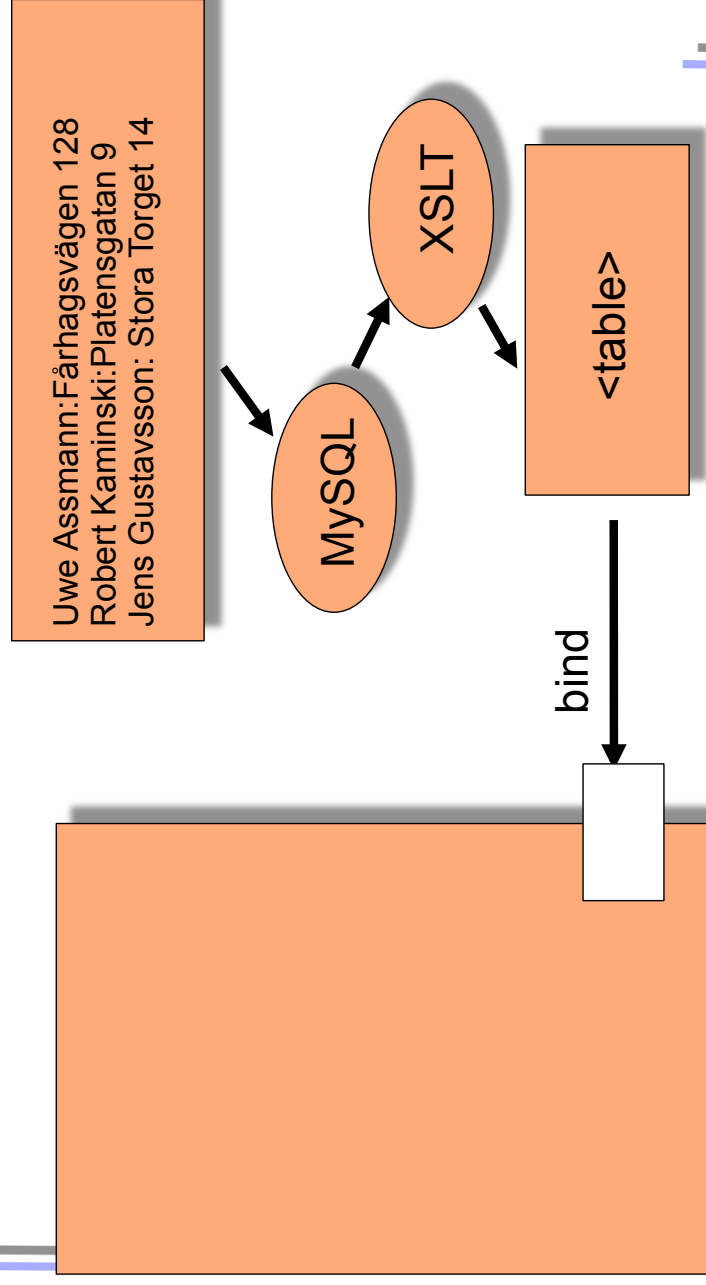



Advantages of Architectures for Active Documents

- ▶ Better reuse
 - Scripts are removed from HTML pages
 - The template can be reused in other contexts where the table expansion is not required
- ▶ A lot of embedded scripts in HTML is composition code
 - let's move it out!
- ▶ Simplifying web engineering



Afterthought: What Flows Through an Active Document

- ▶ In contrast to a software architecture, in active documents document fragments flow
 - Like in a spreadsheet, the dataflow graph is acyclic (spreadsheet-documents)
 - Generation and modification of values are modeled with export declaration languages (script languages)
- ▶ In contrast to a software architecture, the values only change when the user changes a component
 - Pushed once through that graph, the document is updated
 - Transclusion works for dataflow graphs!
- ▶ **Requirements for Active Document Architectures**
 - *Fragment queries* or export definitions
 - *Invasive embedding* of results
 - *Hot update* of all computations (aka transconsistency)

41.4) Transconsistency – A New Architectural Principle for Hot Update in Composed Active Documents

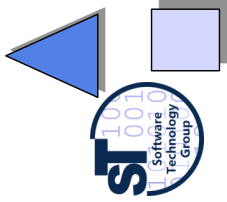

CBSE, © Prof. Uwe Alsmann

45

Transclusion



▶ Transclusion is *embedded sharing of document components in distributed edits*

- Invented by Ted Nelson, the inventor of hypertext
- ▶ „hot update“ (incremental update)
 - Every change in a definition is immediately shared by all uses
 - Realized by reference and special edit protocols
 - Semantics is between call by name and call by value
- ▶ Nelson says: “That’s what the computer is all about”

[http://xanadu.com.au/
ted/](http://xanadu.com.au/ted/)

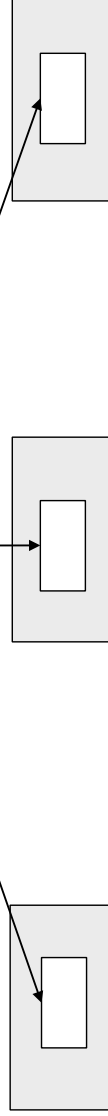

Prof. U. Alsmann, CBSE

46

Hot Update is Necessary in Active Documents

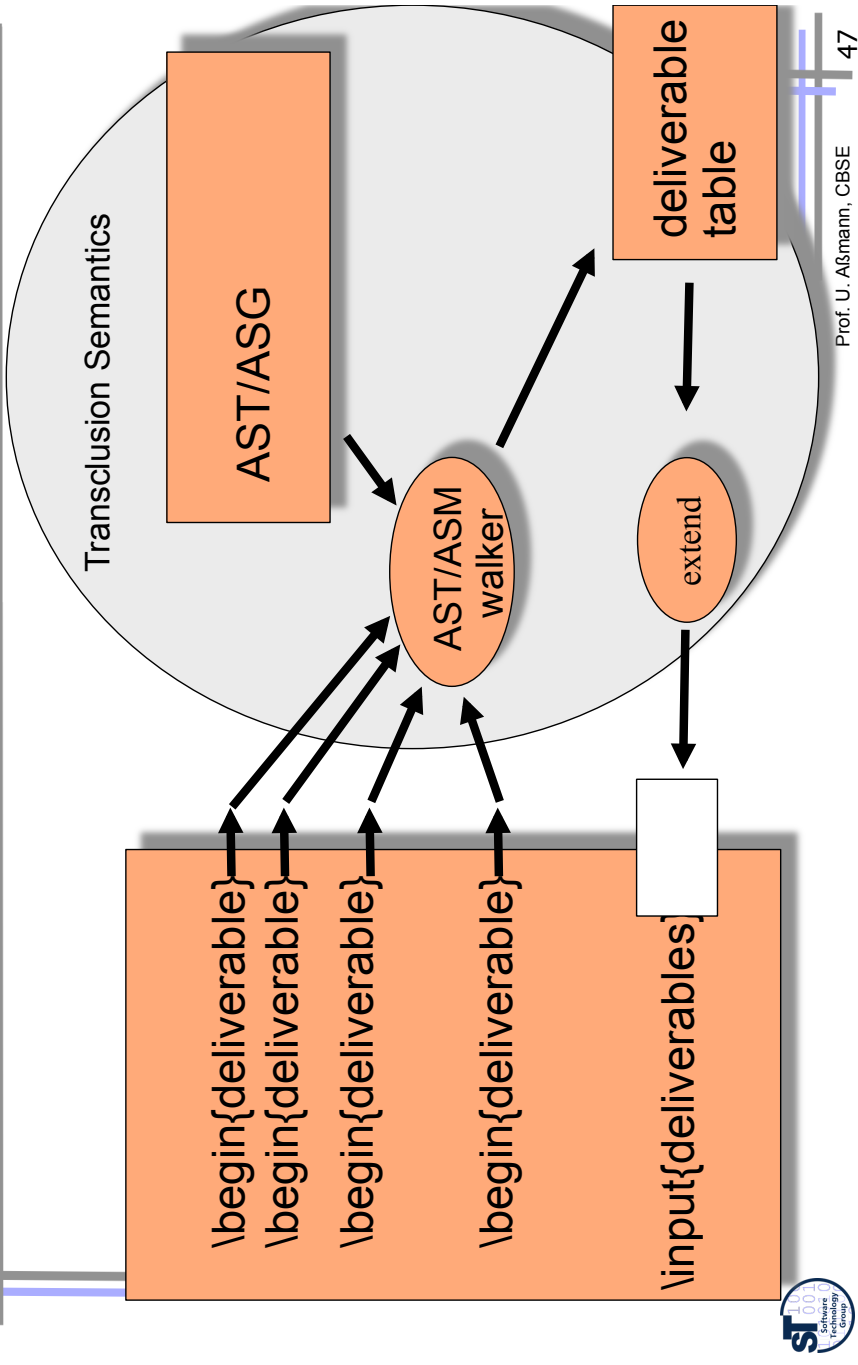

Transconsistency of Active Documents (Immediate Update)

- ▶ The architecture of an active document should obey *immediate (hot) update (transconsistency)*
 - Transclusion only deals with equality of hooks, but does not treat operations or modifications
 - Dependent components must be updated immediately
- ▶ For transconsistency, transclusion is a basis
 - Transconsistency requires a data-flow graph over operations in the document, i.e., a data-flow-based architecture
 - Whenever the input of a slice of the data-flow graph changes, recompute the result by reevaluating the slice
- ▶ Transconsistency requires *invasive embedding*
 - The component model of an active document must be graybox, otherwise embeddings are not possible

41.4.1. A Graph-Theoretic Definition of Transconsistency

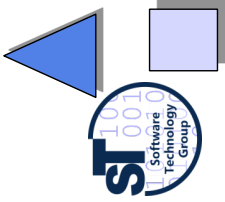

Transclusion in Flow Graphs of Embedding Operations

- ▶ Let D be a dataflow graph of *embedding operations*, a bipartite graph of EmbeddingOperations and Values.
- ▶ D is called *transclusive*, if:
 - If an input value changes, all dependent values are declared inconsistent immediately, until they are reembedded

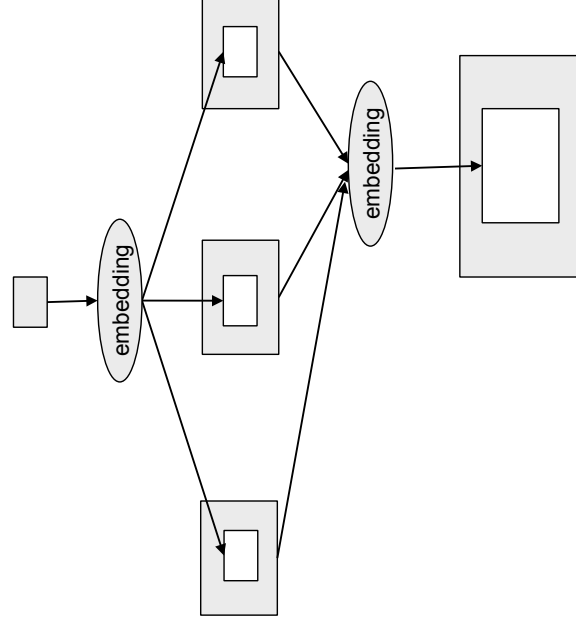



Transconsistency in Data Flow Graphs

- ▶ Let D be a dataflow graph, a bipartite graph of Operations and Values.
- ▶ D is called *transconsistent*, if the *hot update condition* is true:
 - If an input value changes, all dependent values are declared inconsistent immediately, until they are recomputed

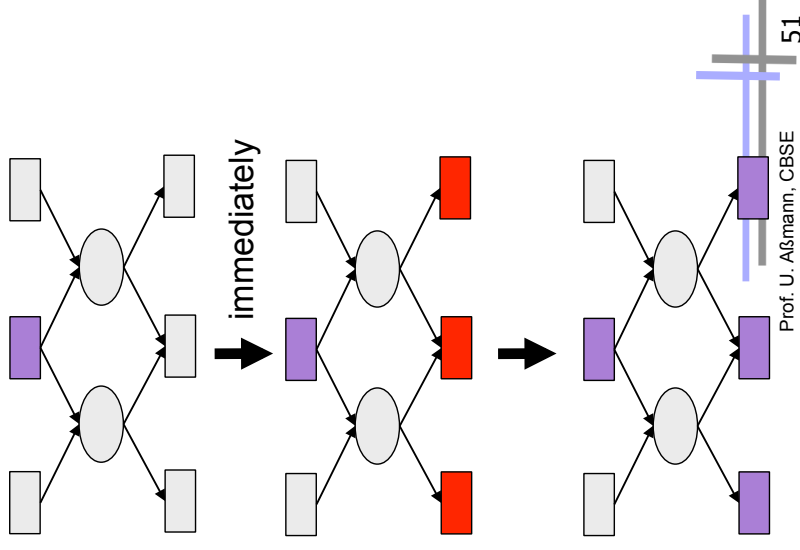

Transconsistency in Active Documents

- ▶ Let A be an active document with an underlying dataflow graph D for document parts.
- ▶ Then, D is called the *architecture* of A .
- ▶ A is called *transconsistent*, if D is transconsistent

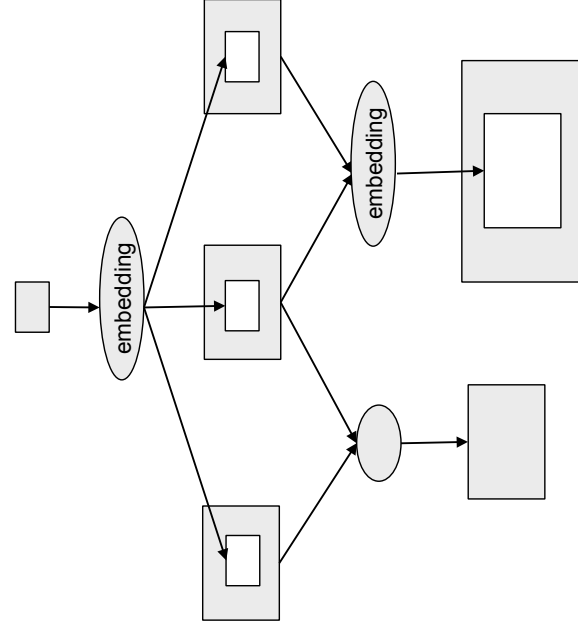

Transclusion and Transconsistency

Transclusion
=
Invasive Embedding +
Incrementality (hot update)

Transconsistency
=
Transclusion +
Data flow graph

Transconsistent Architecture
=
Transconsistency + Architecture

Transconsistency Goes Beyond Transclusion

- ▶ Transclusion only treats embedding and hot update
- ▶ It does not treat
 - Operations beyond embedding
 - Data flow graphs of these operations
 - Components





Examples for Transconsistency

Spreadsheets: A spreadsheet relies on a dataflow graph (pipe-and-filter)

- It is a set of slices, i.e., a set of expressions, or scriptlets
 - A scriptlet describes a dataflow graph of operations
 - Every slice is independent, i.e., can be recomputed independently
- ▶ Spreadsheets are simple active document with transconsistency, i.e., immediate update
- ▶ Spreadsheets do not have architecture
- No component model nor composition interface

Web Documents: Servlet-based documents rely on re-expansion if users change forms or templates

- ▶ The servlets span up a data flow graph
- Templates and form inputs are the inputs
 - Result pages the output
- ▶ The regeneration is an implementation of transconsistency



41.4.2 Transconsistent Architecture:



Uniform Composition of Active Documents with Staging
and Transconsistency

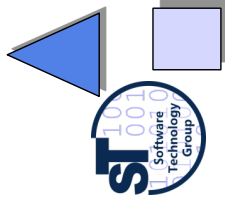



Transconsistent Documents

- ▶ *Transconsistent documents* are active documents with explicit *transconsistent architecture*
 - Like spreadsheets, but with explicit architecture
 - Based on a
 - Dataflow graph
 - Graybox component model (invasive embedding)
 - Incrementality (Hot update)
- ▶ **Purpose of Transconsistent Architectures**
 - Transconsistency copes interactive editing
 - This is fundamentally different to the so-far batch-oriented style of software construction, software build, and software execution
 - Transconsistency is needed in software editing, too



41.5 Transconsistent Architectural Styles



Composition of Active Documents with Staging and Transconsistency

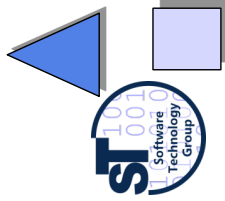

Web Form Processing with JSP

- ▶ Should be transconsistent...

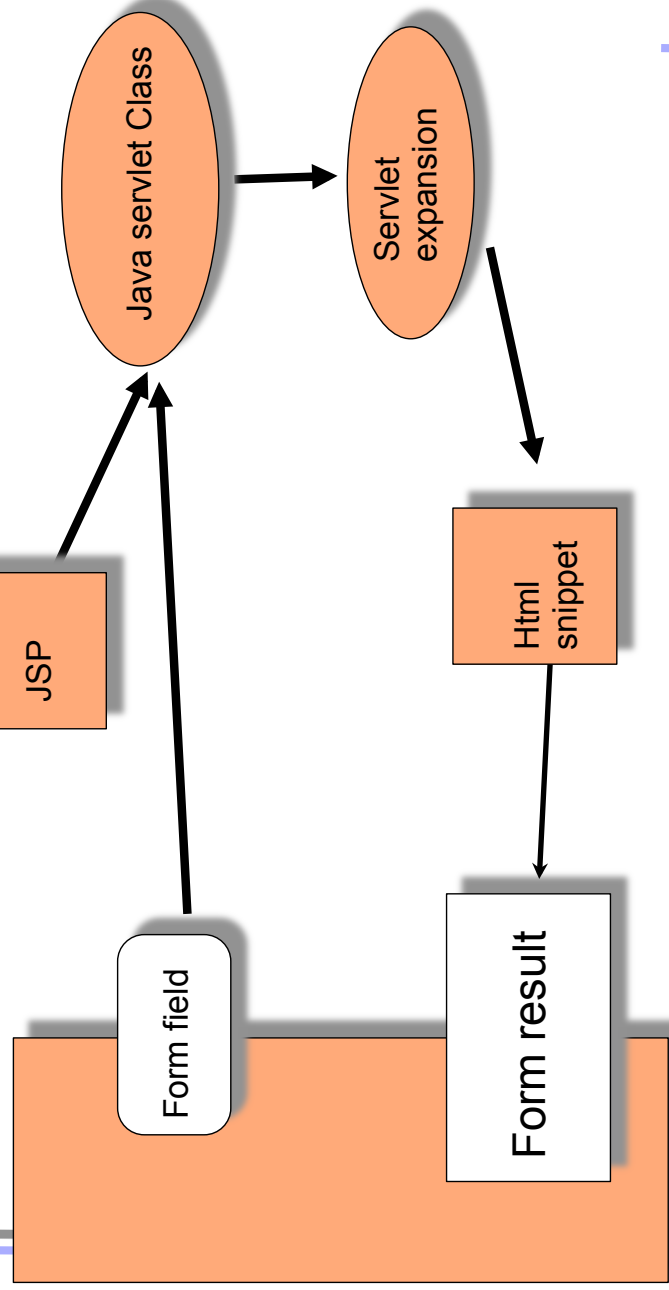

Spreadsheet-documents and Pipe-And-Filter Architectures

- ▶ **Spreadsheet-Documents:** A spreadsheet-document is an active document with a pipe-and-filter architecture
 - Resembles spreadsheets
 - The question is how often the filter architecture is evaluated for transconsistency
 - A web form (e.g., JSP) is a *distributed spreadsheet-document*



2-Pass Transconsistent Documents

- ▶ Transconsistent documents underly a dependency graph for their update
 - This dependency graph must be acyclic
- ▶ Evaluation classes for transconsistent documents
 - 1-pass problems along the document (all definitions before uses)
 - 2-pass (backpatch problems) along the document
 - Statically orderable along the dependencies (similar to wavefront or OAG)
 - Form processing

Citations and Bibtex (2-Pass-Document)

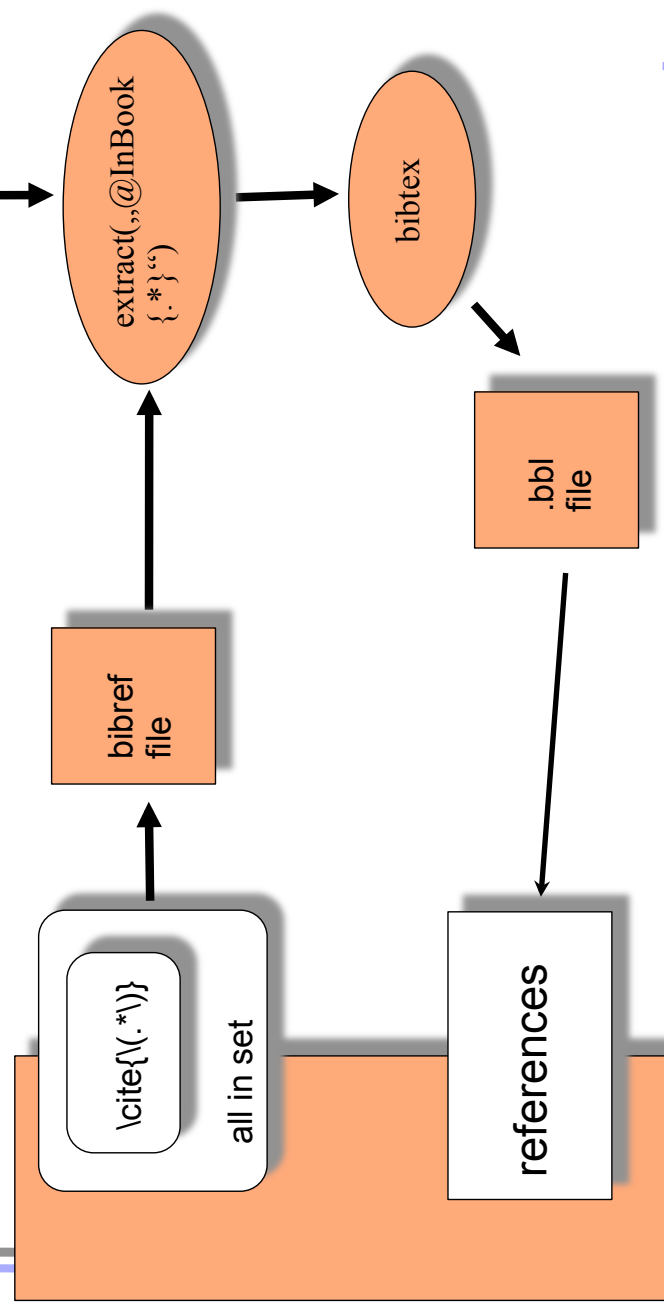

References (2-Pass-Document)

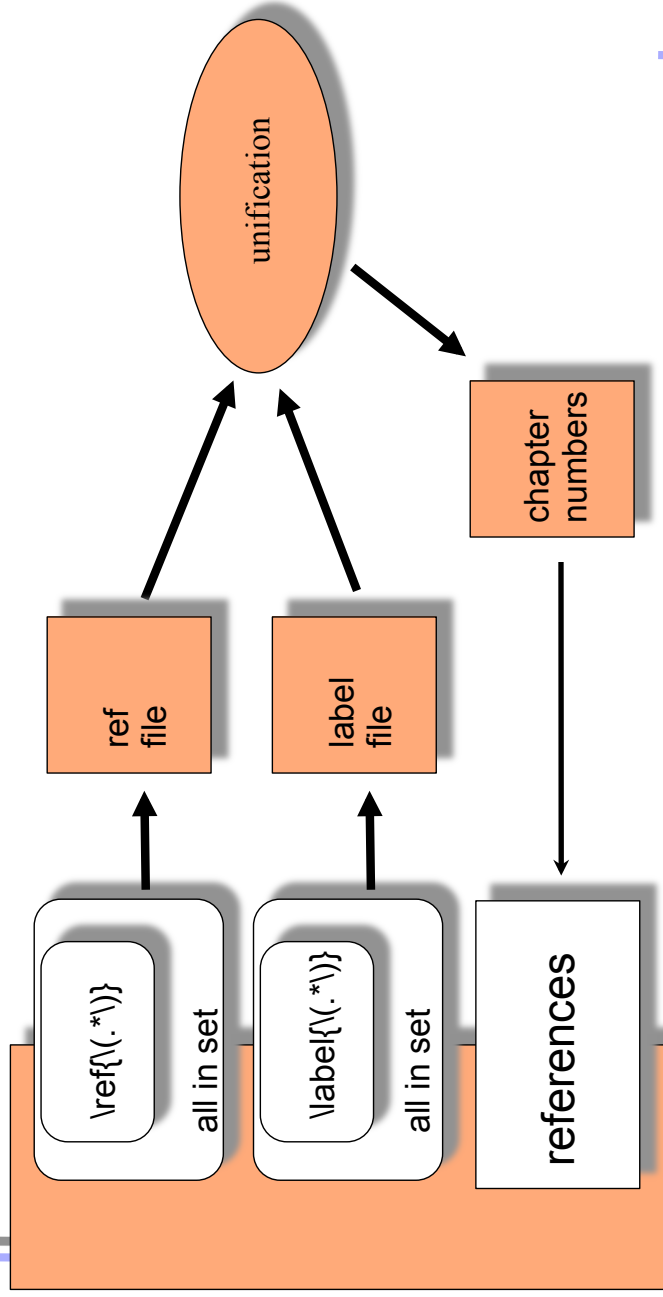

Central Tables (2-Pass-Document)

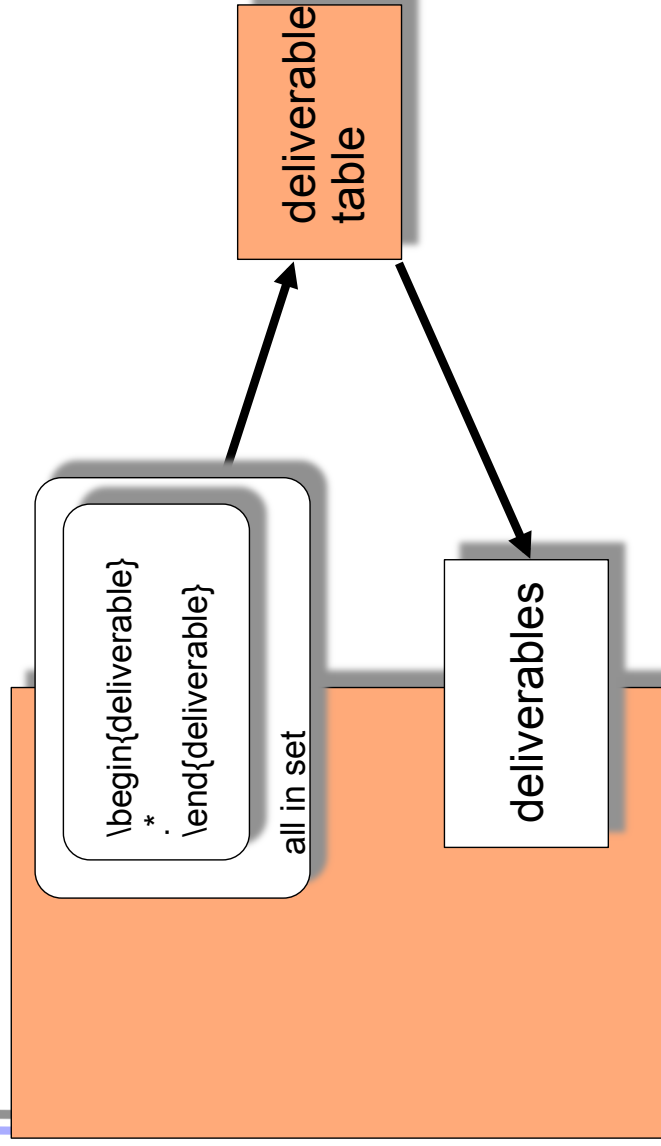

Person Cost Calculation Central Tables (2-Pass-Document)

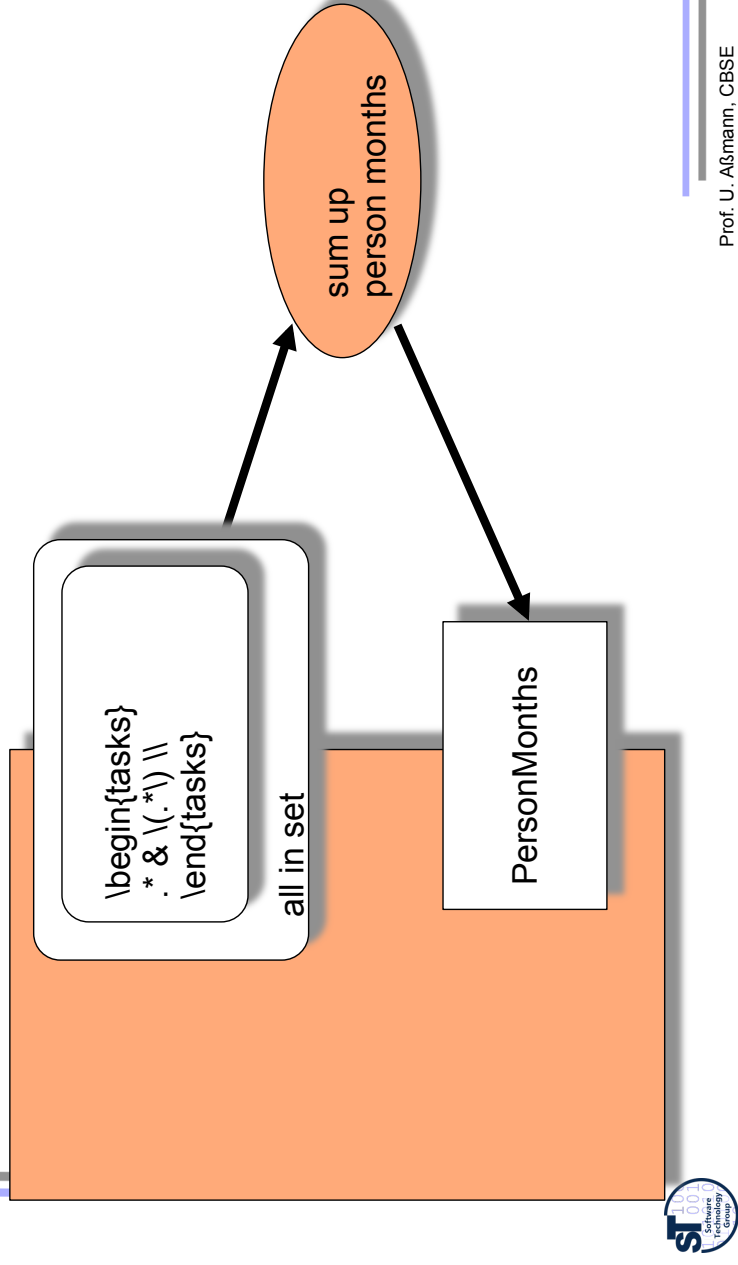

Prof. U. Alsmann, CBSE

65

Stream-Documents (Spreadsheet Documents with Pipe Ports)

- ▶ Instead of being a closed document, spreadsheet-documents can be open in the sense that they take in data streams over stream ports
 - START submission phase
 - START reviewing phase
- ▶ Such a change corresponds to a document extension, but works via communication channels/connectors
- ▶ User changes and sends via ports are the similar effects
 - User change: change component values
 - Send via ports: change from external world

Transconsistent Documents: Roundtrip Engineering Documents

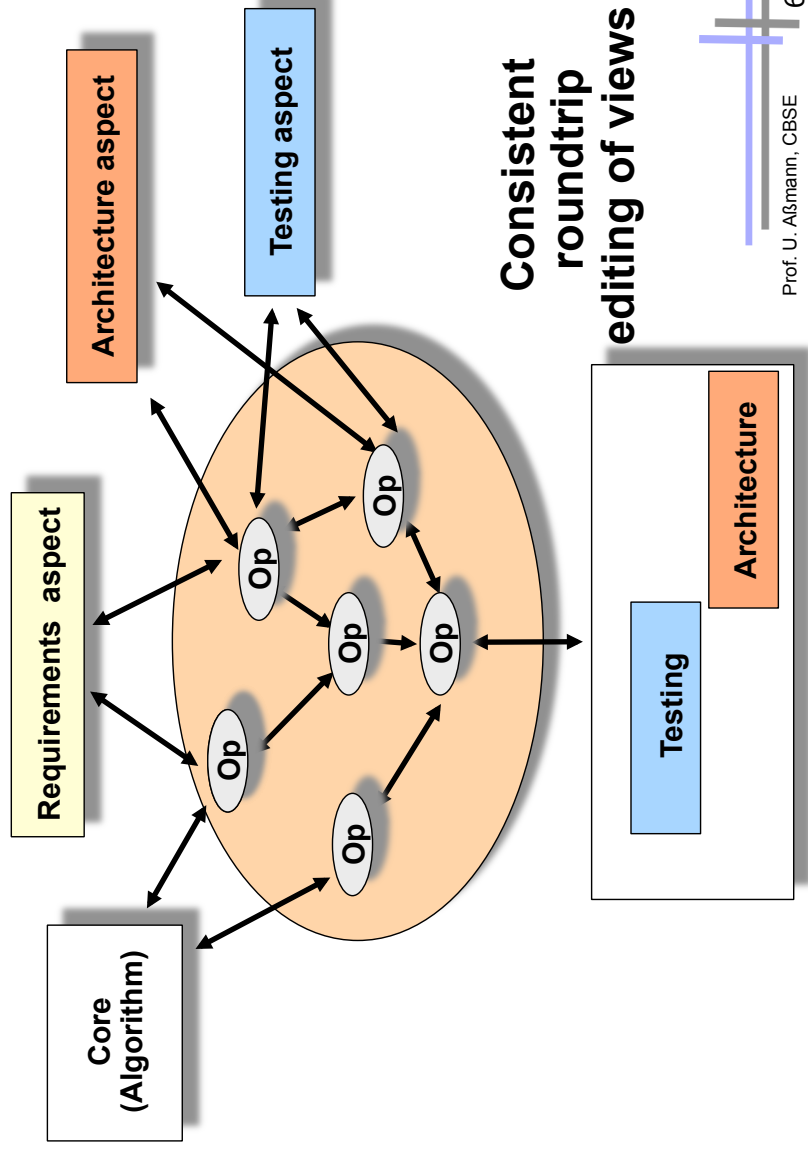

Transconsistent Architectural Styles for Active Documents

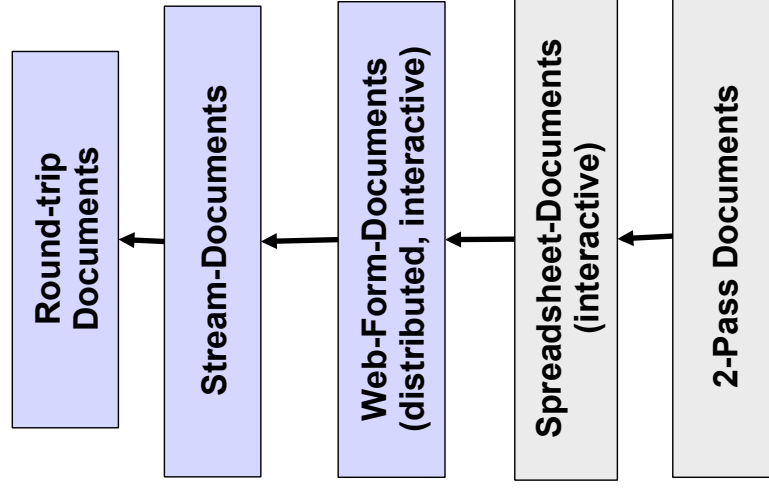

Benefit of Transconsistent Architectures For Active Documents

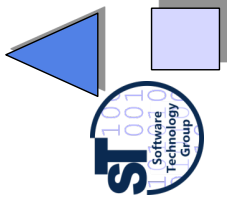

CBSE, © Prof. Uwe Alsmann

69

Advantages of Transconsistent Active Documents

- ▶ **Beyond standard document models (such as OLE):**
 - Explicit distinction between architecture and content
 - Better reuse
 - Can be combined with staged composition for Web engineering
- ▶ **Beyond spreadsheets:**
 - Full table and sheet extension, not only value transconsistency (table extension hot update)
- ▶ **Beyond template-based documents:**
 - Decentralized definition of databases/relations
- ▶ **Benefits for Web Engineering**
 - Transconsistent active documents provide a first unified model for web- and document engineering
 - Beyond simple approaches such as JSP, ASP
 - Improvement of quality:
 - Documentative due to architecture
 - Gets rid of the spaghetti code in web engineering



Summary

- ▶ For engineering of active documents, explicit distinction of architectures is important
 - Invasive embedding is required
 - Data flow graphs are required
- ▶ Transconsistent architectures are an important architectural styles for active documents
 - Rely on an extended concept of transclusion
 - Cope with streams of interactive input



The End

