

11. Transparency Problems and the Decorator-Connector Pattern

A Design Pattern appearing in all classical component systems

Prof. Dr. Uwe Alßmann
Technische Universität Dresden
Institut für Software- und
Multimediatechnik
<http://st.inf.tu-dresden.de>
Version 13-1-0, May 2, 2013

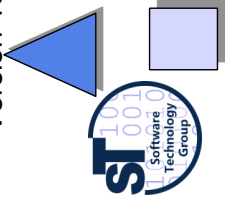

1. Transparency Problems
2. Decorator-Connector Pattern
3. Interface Definition Languages
4. Location Transparency
5. Name Transparency and Trading
6. Optional:
 1. Example YP Service
 2. Generic Skeletons

CBSE, © Prof. Uwe Alßmann

1

Service-Oriented Architecture

- When the Object Management Group (OMG) was formed in 1989, **interoperability** was its founders primary, and almost their sole, objective:

A vision of software components working smoothly together, without regard to details of any component's location, platform, operating system, programming language, or network hardware and software.

Jon Siegel

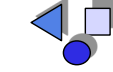

Risks of using other people's legacy libraries ***<http://catless.ncl.ac.uk/Risks/27.23.html#subj17>***

Phil Nasadowski pnasadowski@pcsintegrators.com Mon, 25 Mar 2013 22:37:34 -0400
We recently ran into a situation where I work, where a vendor's (a large, well-known, multinational company with a two letter abbreviation for it's name) piece of software was not fully compatible with Windows 7, 64bit. In particular, a portion of the UI that's very, very useful for looking at variables, is broken.

Being that the software in question was a development package for their programmable logic controllers, and the widespread use of Windows 7 / 64 bit in our office, a call to the vendor was in order. The vendor replied that they were *not* going to update the package for 64 bit operating systems and there was *no* workaround.

A bit of pressing and a few nasty emails later, we got the full story:

Apparently the software uses a library developed by an outside firm. That firm went bankrupt and is no longer in business. There is no copy of the source code to the library. The library is not 64 bit compatible. Thus, the vendor is forced to rewrite a portion of his software in house. Or seek another library. Or something.

We are stuck with a piece of broken software for the mean time. They say maybe 6 months to a year to fix it. I doubt we're alone.

I'm sure this isn't the first time this has happened. I'm sure it won't be the last. It's a risk of relying on someone else's library to do something. If they go away, you may be stuck with incompatible software. And your customers won't be happy about it.



Philip Nasadowski, Project Engineer, PCS Integrators

- 3

11.1. Transparency Problems ***for COTS***

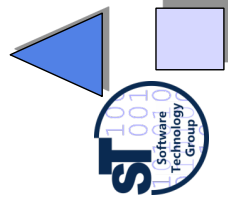

Transparency Problems (Middleware Concerns)

- ▶ A transparency problem describes software concerns that should be transparent (invisible, hidden) when you write, deploy a component.
 - ▶ To solve a transparency problem, the component model requires different secrets
- ▶ **Content secrets**
 - ▶ **Language transparency:** interoperability of components using different programming languages
 - ▶ **Persistence transparency**
 - Hide whether server has persistent memory
 - ▶ **Lifetime transparency**
 - Hide whether server has to be started
- ▶ **Connection secrets**
 - ▶ **Location transparency:** distribution of programs
 - Hiding, where a program runs
 - ▶ **Naming transparency:** naming of services
 - Hiding, how a service is called
 - ▶ **Transactional transparency**
 - Hide whether server is embedded in parallel writes
 - ▶ **Security scaling**
 - Plug-in authentication

Idea: Encapsulate Transparency Problems

- ▶ **Components encapsulate content secrets**
 - ▶ Ports abstract required and provided interface points of components (event channels, methods)
 - ▶ Ports specify the data-flow into and out of a component
- ▶ **Connectors are special communication components encapsulating connection secrets**
 - Connectors are attached to ports
 - Connectors abstract from the concrete communication carrier
 - Can be binary or n-ary
 - Connector end is called a *role*
 - A role fits only to certain types of ports (typing)

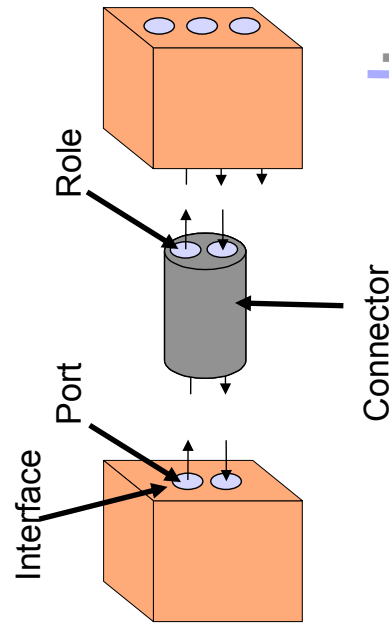

11.2 The Decorator-Connector Pattern

Connectors can hide implementation issues for connection transparency problems

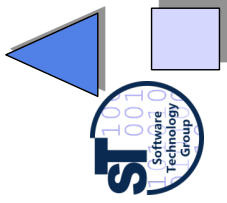

CBSE, © Prof. Uwe Alsmann

7

Language Transparency With the Connector Pattern

▶ The Connector Pattern (Double-Decorator Pattern, n -Decorator Pattern) can be used in a standard object-oriented language to implement connectors for classes and objects

- Stub: Proxy of the client (decorator of the skeleton)
 - Takes calls of clients in language \mathcal{A} and sends them to the skeleton
- Skeleton: Proxy (decorator) of the server
 - Takes those calls and sends the component implementation in language \mathcal{B}

▶ Language adaptation in Stub or Skeleton (or both)

- Adaptation deals with calling concepts, etc. (see above)
- Based on a mapping of language constructs from both languages, defined by an Interface Definition Language (IDL)

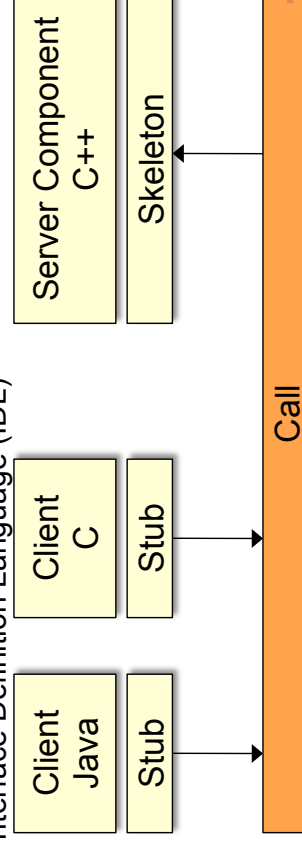

Basic Idea: Stubs and (Static) Skeletons as Decorators

- ▶ A typical instance of the Decorator pattern: two proxies on client and server
- ▶ Stub decorates skeleton, skeleton decorates server

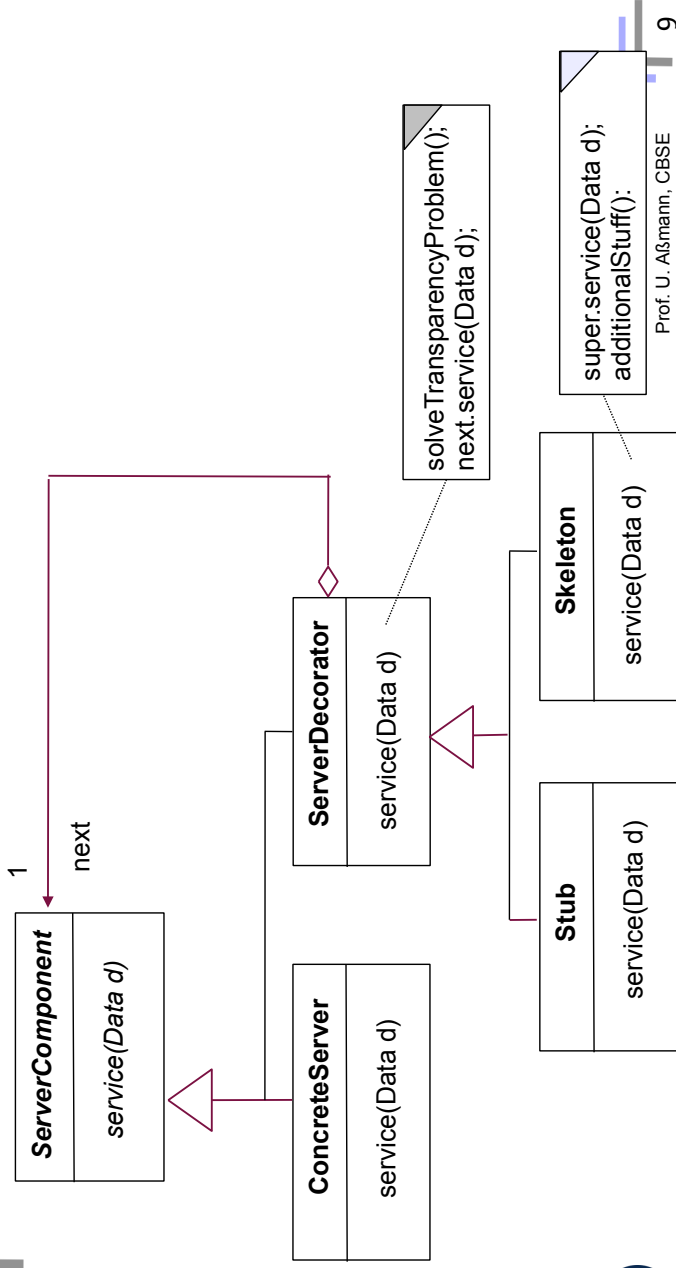

The Decorator-Connector Pattern

- ▶ Client and server are connected via a layer of stubs and skeletons (the *connector*)
- ▶ The connector consists of two decorators of the server
- ▶ Decorator chain is inherited

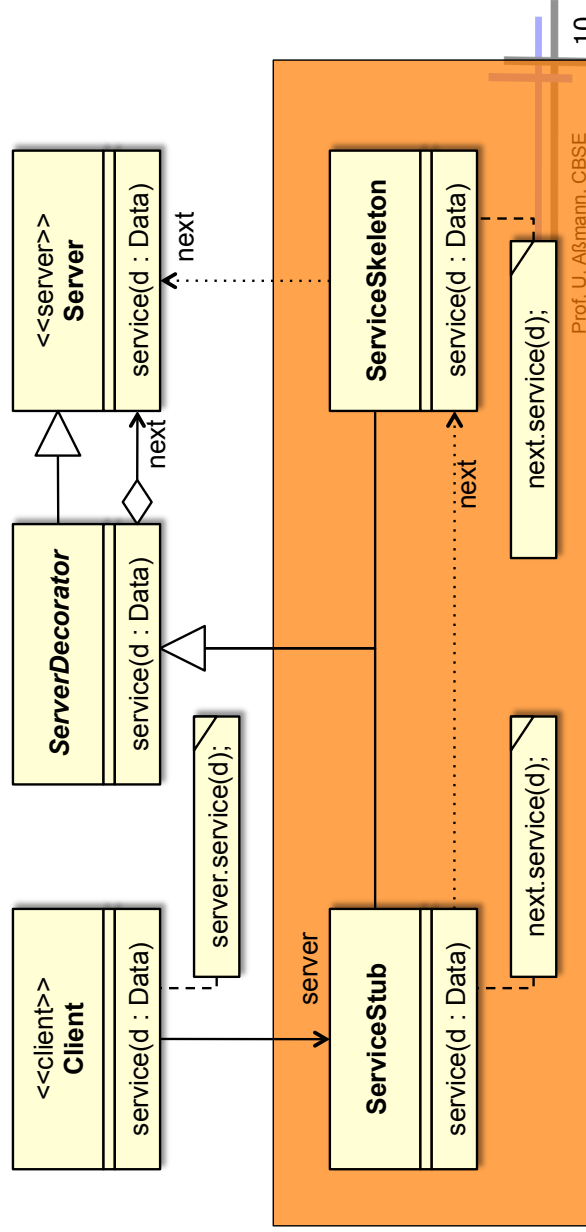

Object Diagram of Decorator-Connector Pattern

- Connector consists of a Decorator chain, in a layer

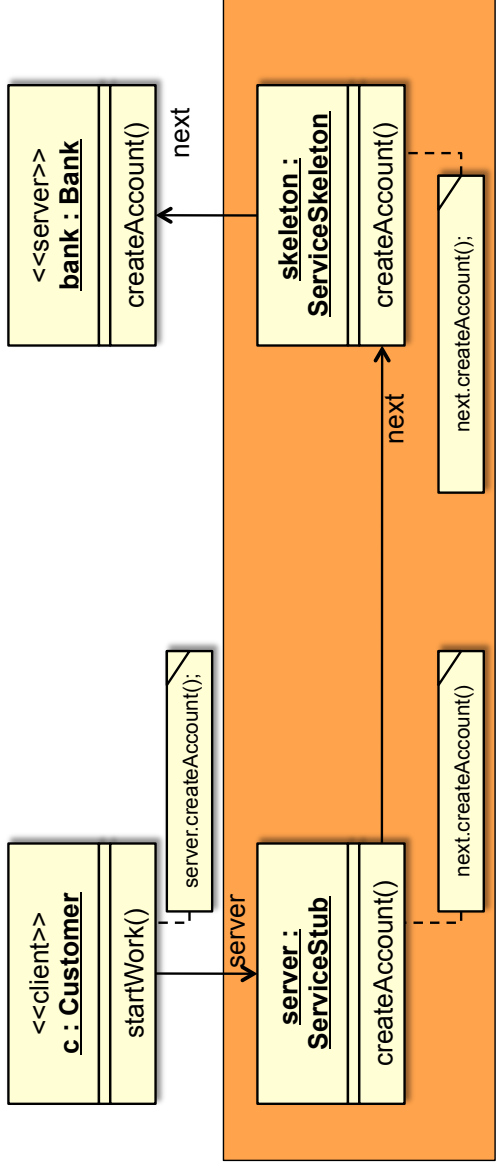

Layered Decorators (Object Diagram)

- More decorators can be stuffed into the connector in additional layers:

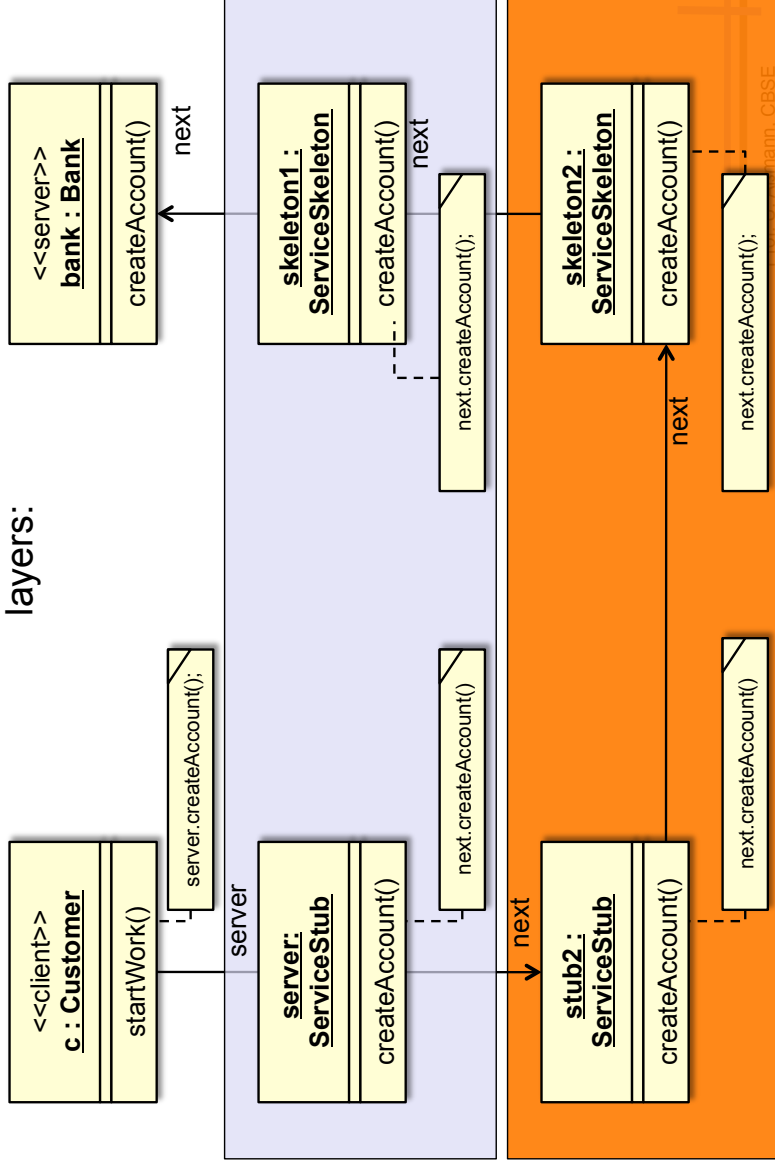



Decorator vs Proxy vs Adapters vs Chain

- ▶ Why should it be a Decorator?
 - Decorators allow for stacking of connectors (layering)
 - Proxy pattern: just *one* representative, no stacking possible
 - However, from the client and server's perspective, stub and skeletons are Proxies
 - Adapter: Adapted interface must be different from Adaptee
 - Chain: In a Chain, the processing may stop (not here..)
- ▶ However, Connectors can use all other basic “representant” patterns
 - Adapter-Connector: adapts required interface to server additionally
 - Chain-Connector: may stop processing
 - Proxy-Connector: just one layer possible



Tasks of the Layers

- ▶ In a component model, every layer of decorator-pairs is devoted to a specific task for *transparency* (*middleware concern*)
 - Language mappings (language interoperability)
 - Distribution handling (serialization, deserialization)
 - Names (name mapping, name search)
 - Persistence
 - Transactions
 - etc.
- ▶ Layers can be composed (stacked) freely



Containers – Infrastructure for all Connectors

▶ A **container** of a server component is an infrastructure for all connectors at run-time (all decorators/proxies).

- Creation (server component factories for service families)
- Transactions (begin, rollback, commit)
- Persistence (activate, passivate)

▪ The container is instance of the Façade design pattern (DPF)

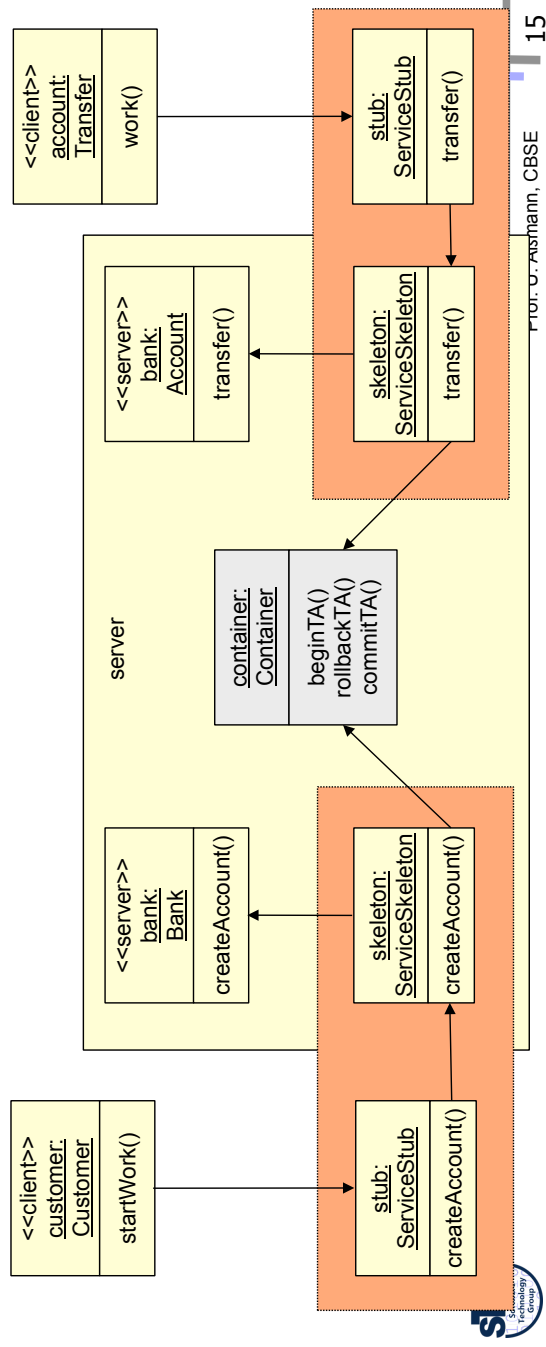

Who Realizes Stubs and Skeletons?

▶ **Programmer**

- Much handcrafting, using Decorator pattern. Boring and error prone

▶ **Generator:**

- Stub
 - Export interface is component dependent, independent of source language
 - Implementation is source language dependent
- Skeleton
 - Import interface is component dependent, independent of source language
 - Implementation is target language dependent

▶ **Idea: Generate export and import interfaces of Stub and Skeleton out of a component interface definition**

- Take generic language adapter for the implementation

11.3 Interface Definition Languages for Mapping Different Languages

Language mediation with the „star approach“

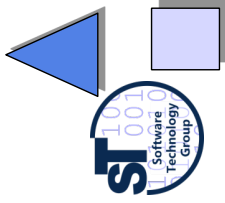

CBSE, © Prof. Uwe Alsmann

17

Transparency Problem 1: Language Transparency

- ▶ Calling concept
 - Procedure, Co-routine, Messages, ...
- ▶ Calling conventions
 - Call by name, call by value, call by reference, ...
- ▶ Calling implementation
 - Parameters on the stack, in registers, allocation and de-allocation
- ▶ Data types
 - Value and reference objects
 - Arrays, union, enumerations, classes, (variant) records, ...
 - Kind of inheritance (co-variance, contra-variance, ...)
- ▶ Data representation
 - Coding, size, little or big endian, ...
 - Layout of composite data
- ▶ Runtime environment
 - Memory management, garbage collection, lifetime ...

Language Mediation - Options In General

- ▶ Direct language mapping (full graph of language relationships):
 - 1:1 adaptation of pairs of languages: $O(n^2)$
- ▶ Mapping to common language (“star approach”):
 - Adaptation to a general exchange format: $O(n)$
 - CORBA IDL
- ▶ Compiling to common basic type system
 - .NET, WSDL

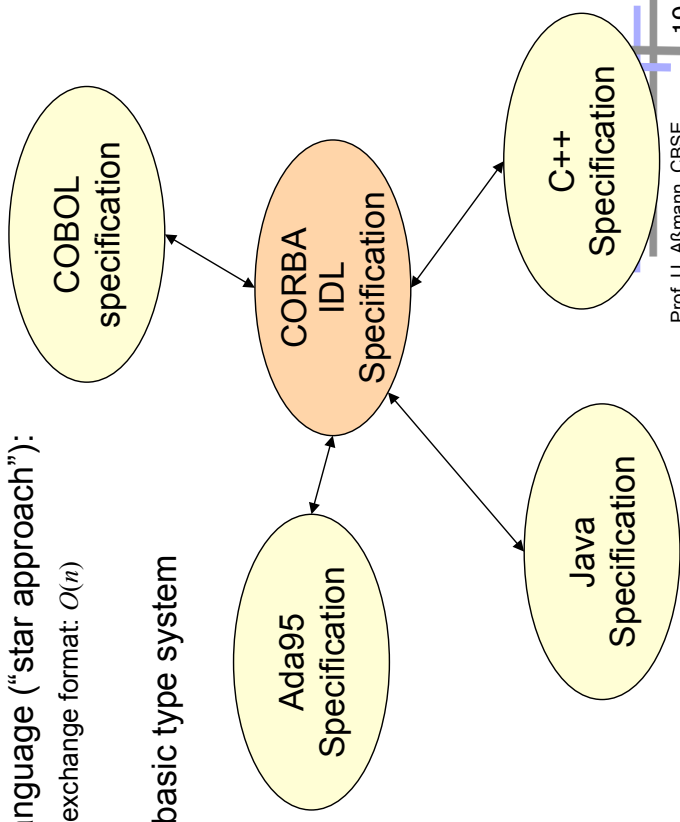

Language Mediation – Common Basic Type System

- ▶ Compiling to common basic type system:
 - Standardize to a single format (like in .NET): $O(1)$ but very restrictive, because the languages become very similar

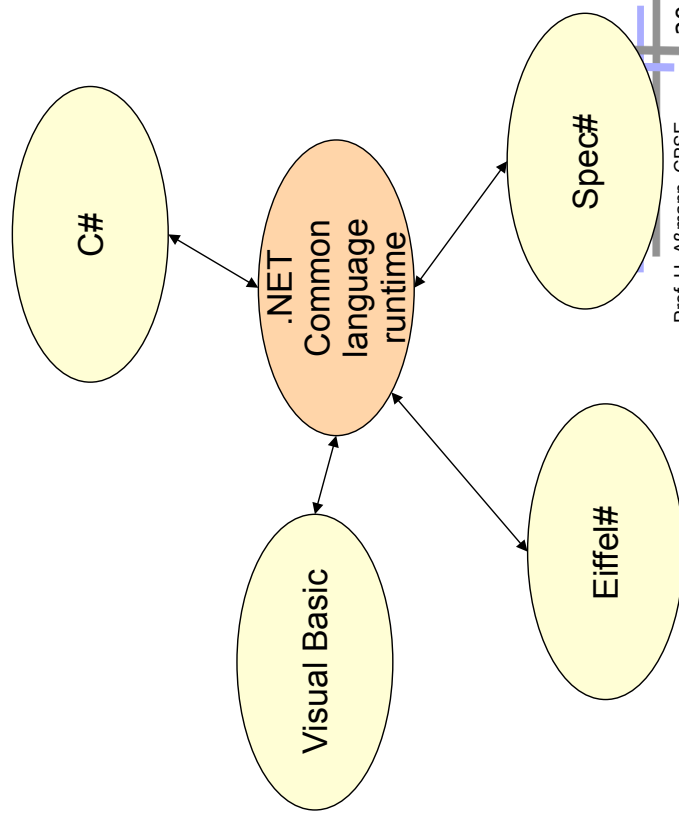

Language Mediation – WSDL

- ▶ Web Service Definition Language (WSDL) uses a similar concept as .NET, but encodes everything as XML

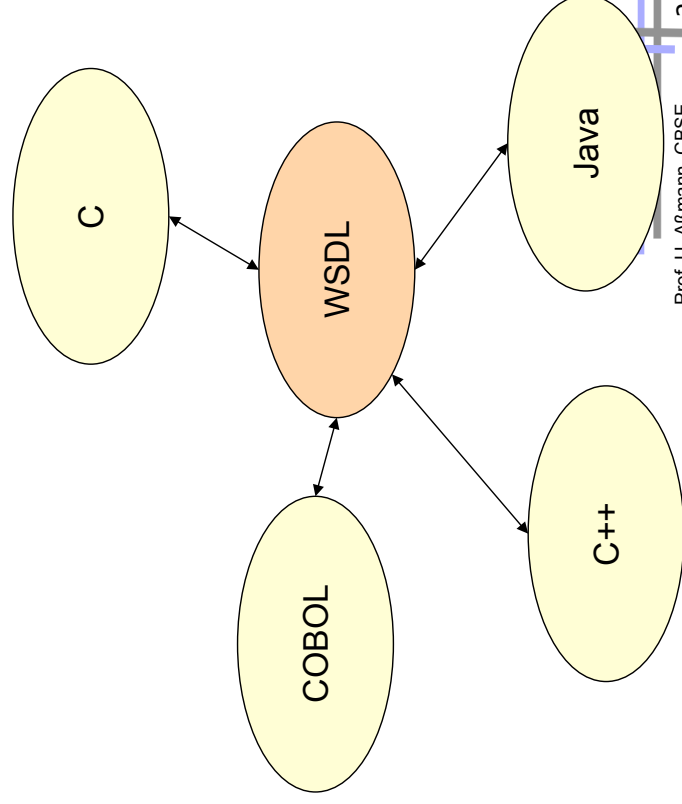

Solutions in Classical Component Systems

- ▶ **Calling concept:**
 - standardized by the communication library (RPC)
- ▶ **Calling conventions:**
 - Standardized by the communication library (EJB - Java , DCOM - C)
 - Implementation for every single language (Corba)
- ▶ **Calling implementation:**
 - Standardized by the communication library (EJB - Java , DCOM - C)
 - Implementation for every single language (Corba)
- ▶ **Data types:**
 - Standard (EJB – Java types)
 - Adaptation to a general exchange format (interface definition language, IDL)
 - CORBA IDL
 - Web Service Definition Language (WSDL)
- ▶ **Data representation:**
 - Standard (EJB – Java representation, DCOM – binary standard)
 - Adaptation to a general format (IDL 2 Language mapping)
- ▶ **Runtime environment**
 - Standard by services of the component systems

Type Mapping with the CORBA IDL

- ▶ An IDL language defines the
 - Interfaces of components
 - Data types of parameters and results
- ▶ Language independent type system
 - General enough to capture all data types in a programming language
 - IDL mediates between type systems of these languages
- ▶ Procedure of construction
 - Define component interface with IDL
 - Generate stubs and skeletons with required languages using an IDL compiler
 - Implement the frame (component) in respective language (if possible reusing some other, predefined components)

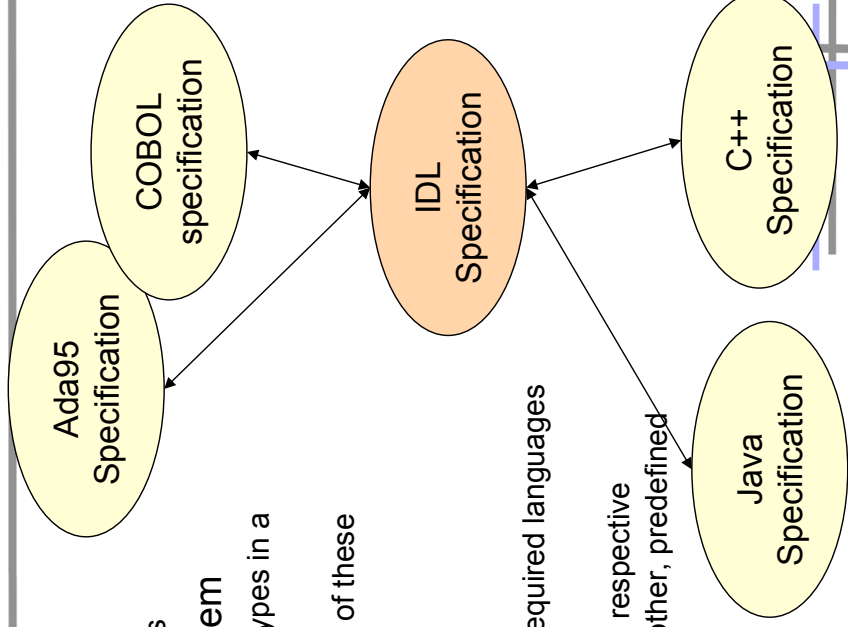

Ex.: Types in the CORBA Interface Definition Language

```
// IDL specification scheme
modules <identifier> {
  <type declarations>
  <constant declarations>
  <exception declarations>
}

// classes
interface <identifier> : <inheriting-from> {
  <type declarations>
  <constant declarations>
  <exception declarations>
  // methods
  optype <identifier>(<parameters>) {
    ...
  }
  ....
}

module HelloWorld {
  interface SimpleHelloWorld {
    string sayHello();
  };
};
```

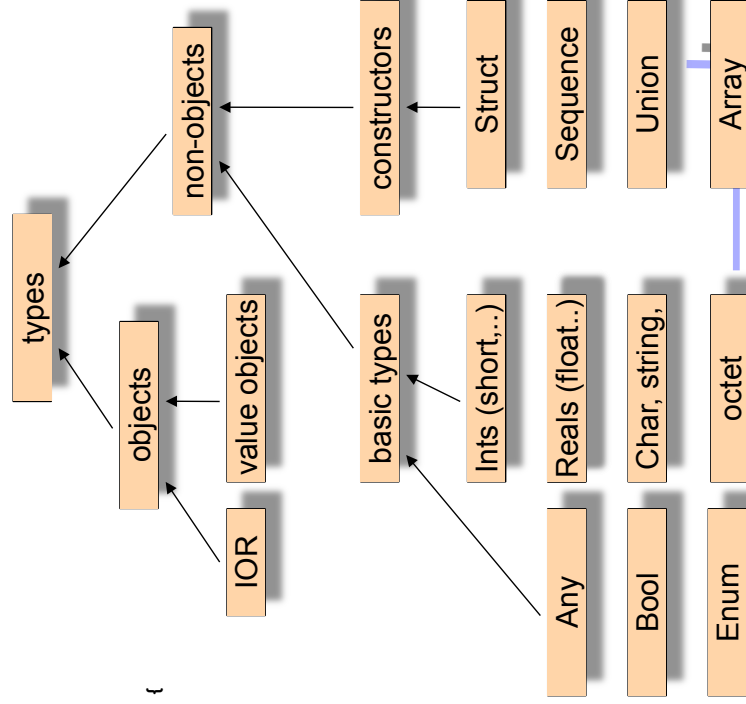

Generation of Stubs and Skeletons from CORBA IDL

- ▶ Generation is done for every involved host programming language (HPL)
- ▶ Interface Repository is queried for component interfaces (introspection)

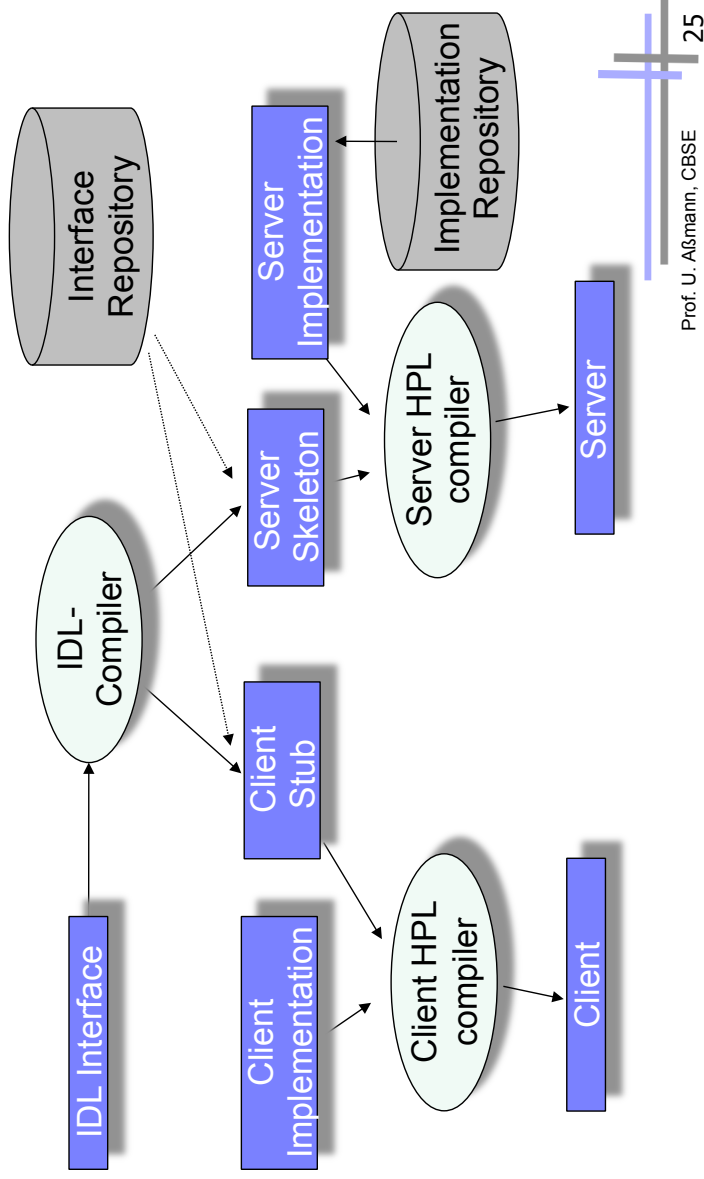

Required Formal Properties of the IDL-To-Language Mapping

- Let $\tau_{PL}: IDL \rightarrow TS_{PL}$ be the mapping from an interface definition language *IDL* to the type system *TS* of a programming language *PL*

1. Well-definedness
 $\forall PL : \tau_{PL}: IDL \rightarrow TS_{PL}$ is well defined
2. Completeness
 $\forall PL : \tau_{PL}^{-1}: TS_{PL} \rightarrow IDL$ is well defined
3. Soundness

$$\forall PL : \tau_{PL}^{-1} \circ \tau_{PL}: IDL \rightarrow IDL \text{ is } \iota_{IDL}$$

$$\forall PL : \tau_{PL} \circ \tau_{PL}^{-1}: TS_{PL} \rightarrow TS_{PL} \text{ is } \iota_{PL}$$

IDL Can Also Be Generated from Host Language

- | <i>Specification of IDL and host language</i> | <i>Specification of host language</i> |
|---|--|
| ▶ Determined language binding, standardized IDL-to-Language mapping | ▶ Retrieve the IDL out of the interface definitions (e.g., Java classes) |
| ▶ Generation of stubs and skeleton is IDL compiler independent | ▶ Have only one source of IDL compilers guaranteeing round-trip property of retrieval and generation for all languages |
| ▶ Language specific IDL compilers | ▶ Quasi standard |
| ▶ OMG Corba | ▶ Java, DCOM, .Net |

Stubs and Skeletons for Language Mediation

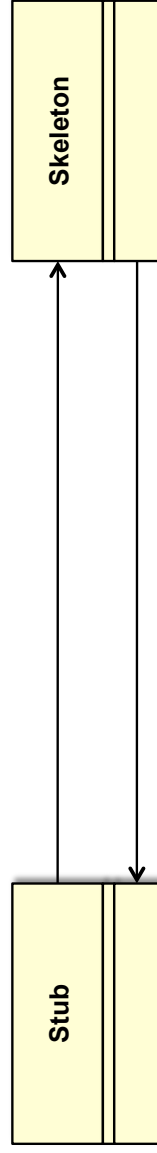

Language 1

Map data to an exchange format (IDL)

Call Skeleton

Language 2

Receive call from stub

Retrieve data from the exchange format (IDL), transform it into language 2

11.4 Location Transparency

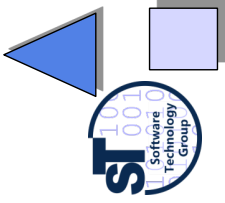

Transparency Problem 2: Distribution

- ▶ *Location transparency*: interoperability of programs independently of their execution location
- ▶ Problems to solve
 - Transparent basic communication
 - Transparently initiate a local/remote call
 - Transparently transport data locally or remotely via a network
 - Transparent references
 - Distributed systems are heterogeneous
 - Platform transparent, concurrent execution?
 - So far we handled platform transparent design of components
 - Usual aspects in distributed systems
 - Transactions
 - Synchronization
 - ...

Transparent Local/Remote Calls

- ▶ Communication over proxies/ decorators
 - Proxies redirect call locally or remotely on demand
 - Proxies always local to the caller
 - ▶ RPC for remote calls to a handler
 - Handler always local to the callee
- Déjà vu! We reuse **Stubs** and **Skeletons**

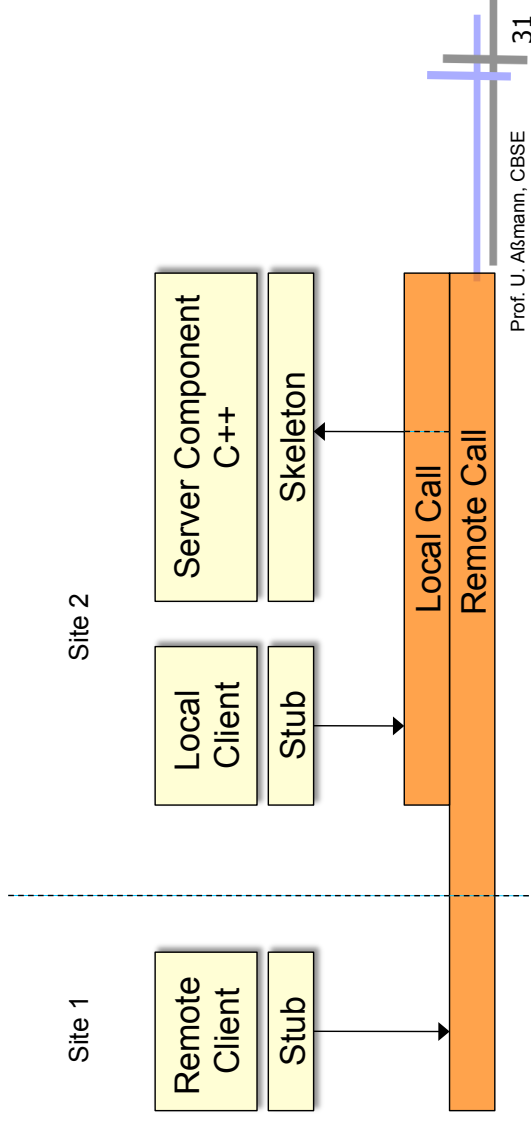

Stubs and Skeletons for Distribution

- ▶ A variant of the Connector pattern, using remote procedure call (RPC) between the decorators

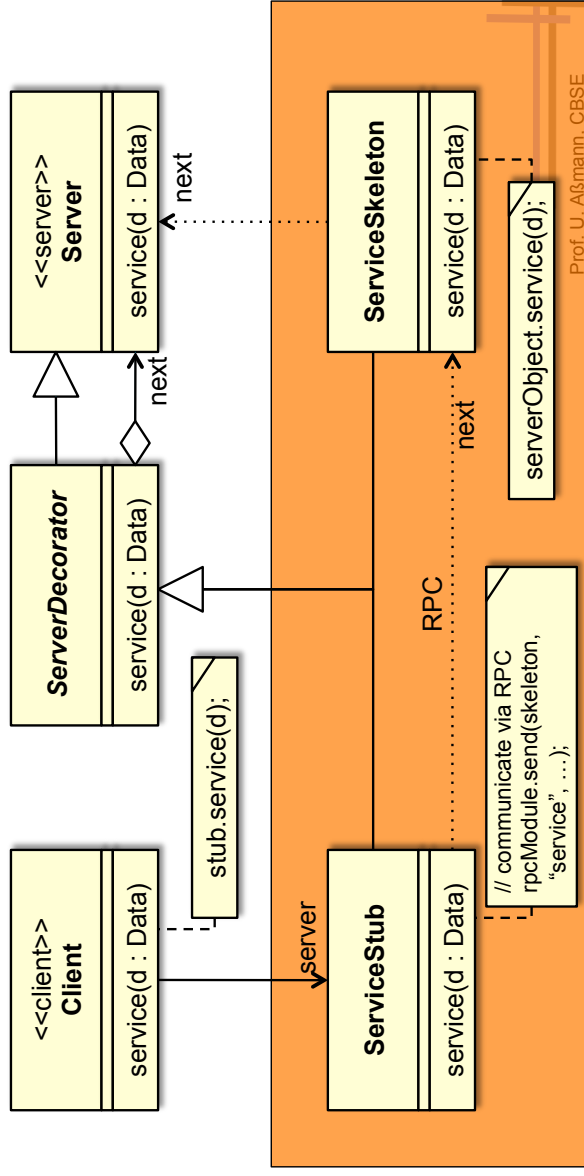

Stubs and Skeletons for Distribution

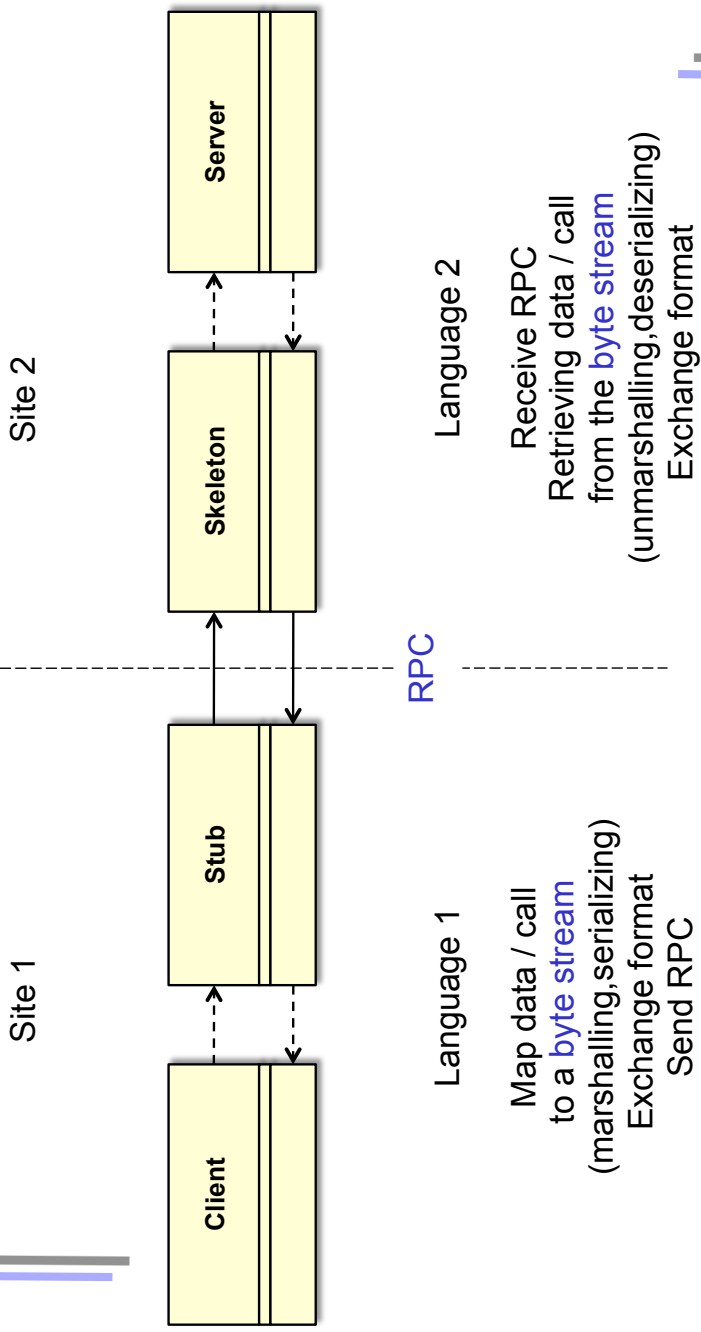

Stubs, Skeletons, and Serializers

▶ or with separate serializers/deserializers

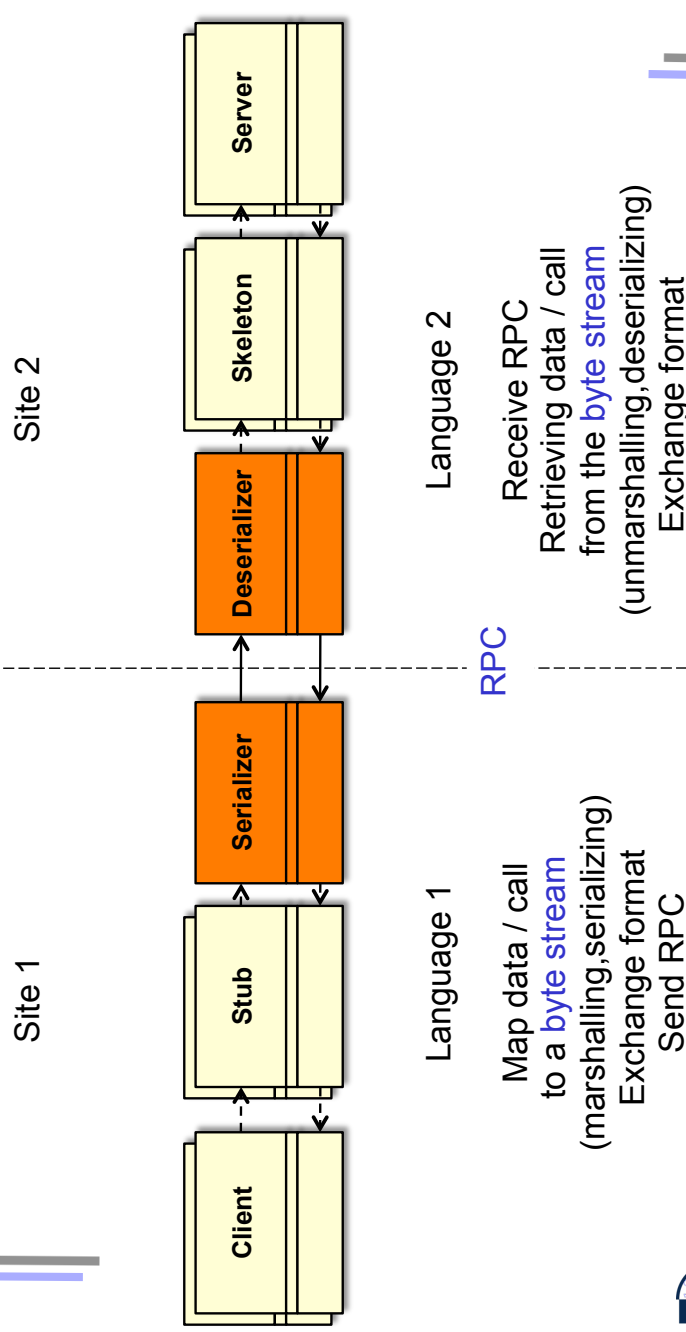

11.5 Name Transparency and Trading

Mapping names to locations by name servers

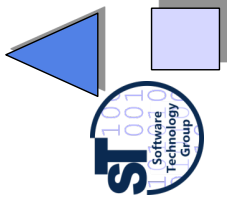

CBSE, © Prof. Uwe Alsmann

35

Transparency Problem 3: The Reference Problem (Name Transparency)

- ▶ How to reference something?
 - Target of calls (services)
 - Call by reference parameters and results
 - Reference data in composite parameters and results
- ▶ Scope of references
 - Thread/process
 - Computer
 - Agreed between communication partners
 - Net wide
- ▶ How to handle references transparently?



Approach: Global Addresses

- ▶ World wide unique *logical* addresses
 - e.g., computer address + local address
 - URL (Uniform Resource Locators), URI (Uniform Resource Identifiers)
 - CORBA IORs (Interoperable Object References)
 - Global file names, e.g., with AFS (Andrew File system)
 - Names in a global cloud file system (DropBox, Skydrive, etc.)
 - Names in a private cloud file system <http://sparkleshare.org/>
- ▶ Mapping tables for local references
 - Logical to physical
 - Consistent change of local references possible
- ▶ One server decorator per computer manages references
 - 1:n relation decorator to skeletons
 - 1:m relation skeletons to component objects
 - Lifecycle and garbage collection management
 - Identification (Who is this guy ...)
 - Authorization (Is he allowed to do this ...)



Change of Local References

- ▶ Why are you interested in a reference?
 - Need a reference to computation service (function)
 - Sufficient to have a reference to the component
 - Decorator creates or hands out an arbitrary object instance on demand
 - Need a reference to store/retrieve data service
 - Use a data base
 - Decorator creates or hands out an arbitrary object instance wrapping the accesses to the data base
 - Need a reference for transaction to leave and resume
 - Decorator must keep correct mapping logical 2 physical address
 - Problems with use of self reference inside and outside service



More Flexible Service Management

- ▶ How to spare server skeletons?
 - IDL compiler must generate code for server decorator deserializer (example code contained the service dispatcher)
 - Solution: only one server side Decorator per site – independent of client components provided
 - flexible service method with name lookup
 - the current solution prevents dynamic loading of services, because code has fixed names; requires regeneration of Decorator
- ▶ Solution: *name service*
 - Decoupling of decorator and skeletons
 - Provide a basic name service for identifying the components (skeletons) of a site, so that the number of services is dynamically extensible
 - Server components register in a service directory (name service) with name and reference
 - Generic adapter looks up, creates, and provides the appropriate service

Name Service

- ▶ Name to Location
- ▶ Located in the container as an associative array (map)

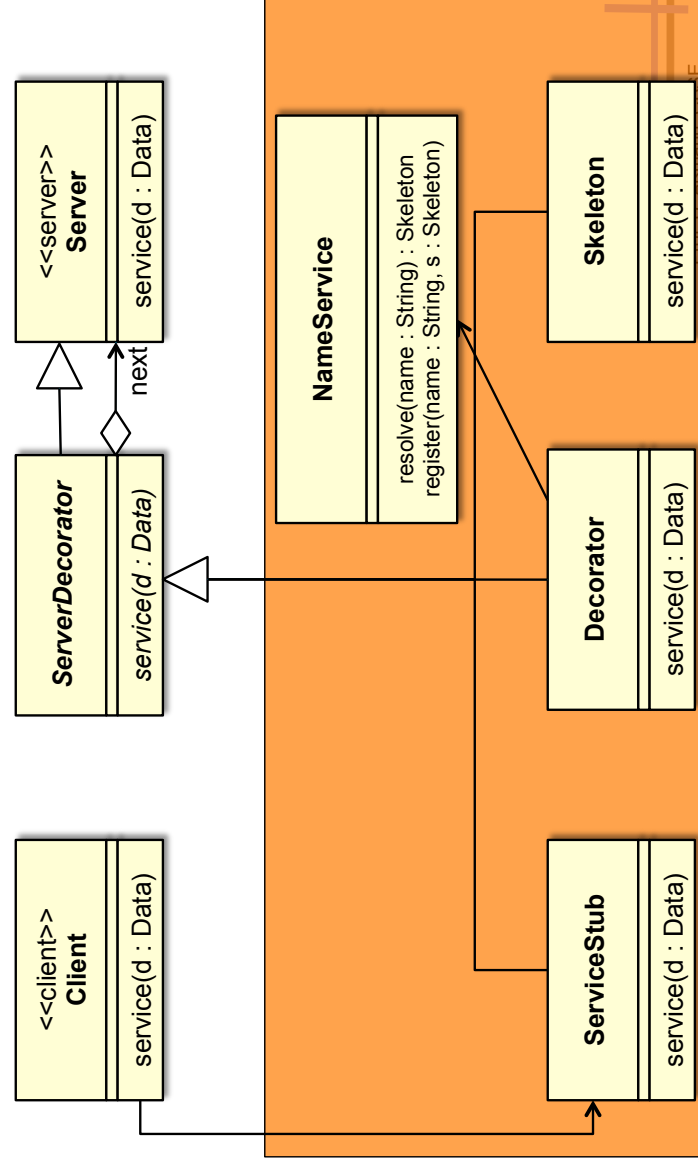

Name Service Generalized (1)

► *Distributed name service (name to location):*

- If name of server is known, search for the right site providing a desired component

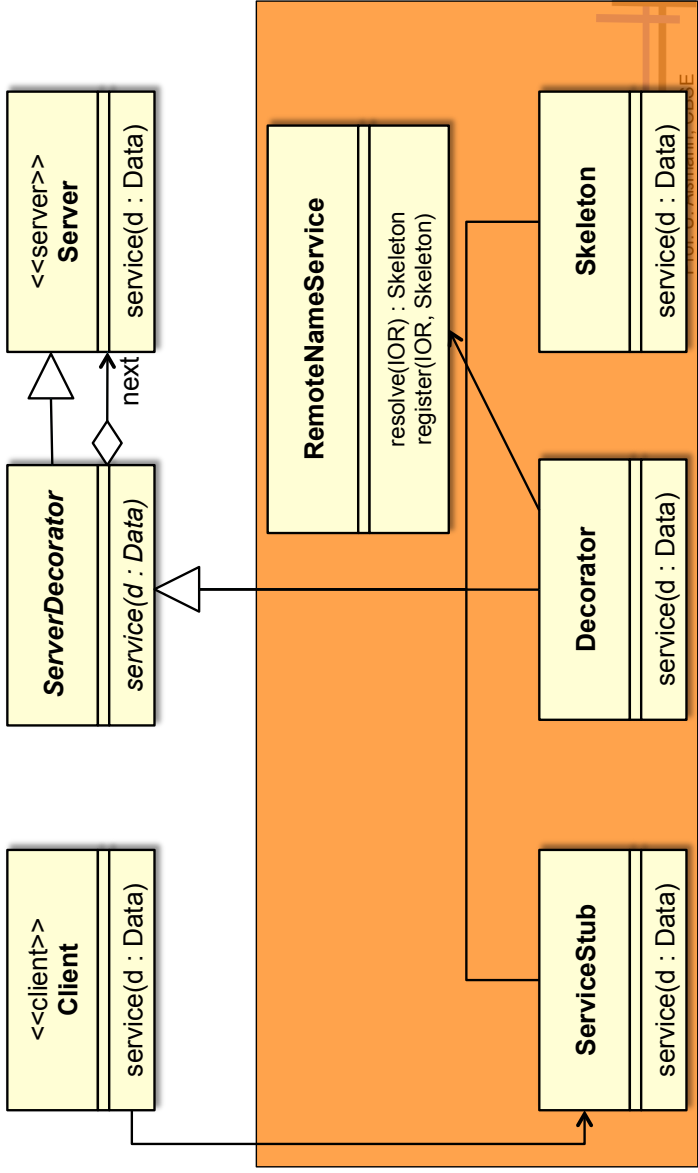

Name Service Generalized (2)

► *Extended name service, dynamic call:*

- If name of server is **not** known, search for the right service with faceted feature description

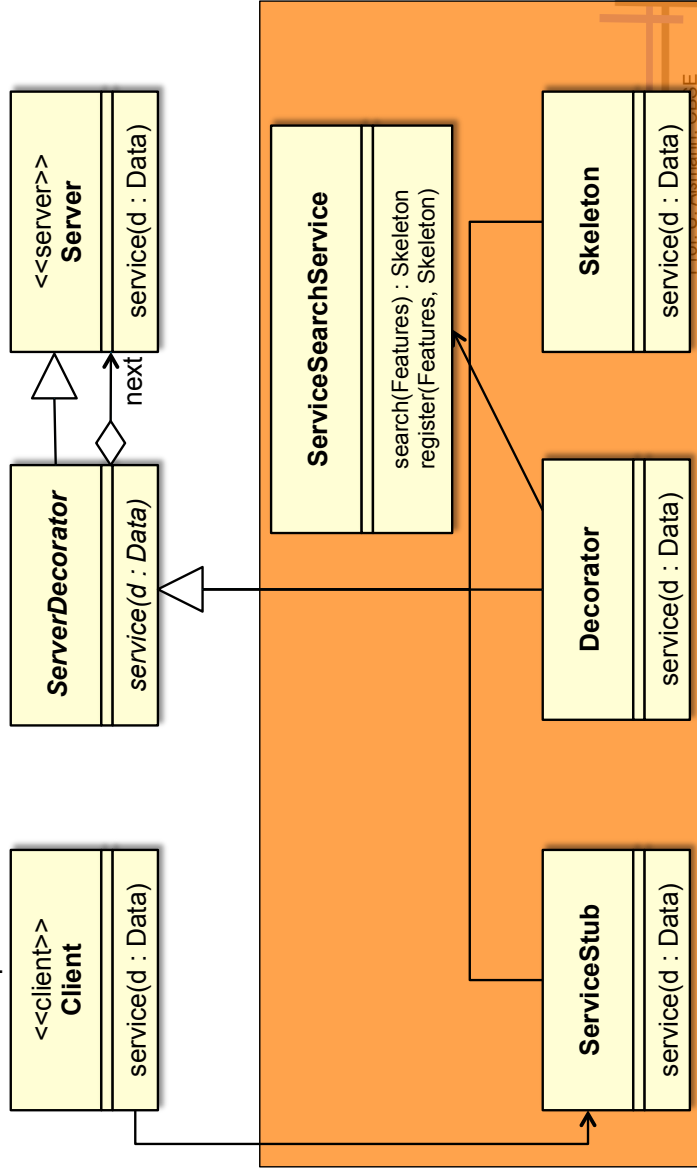



Traders as Generalized Name Servers

▶ **Trader service, traded call** map properties to name or properties to location

- Search for a server component with known properties, but *unknown* name
- Server components register at a *trader* with name, reference, and lookup properties (metadata)
 - The trader has a component repository (*registry*)
 - Instead of names, lookup of service matches properties (metadata)
 - Return reference (site and service)
- Matching relies on standardized properties
 - Terminology, Ontology in facets (see “Finding components”)
 - Functional properties (domain specific functions ...)
 - Non-functional properties (quality of service ...)

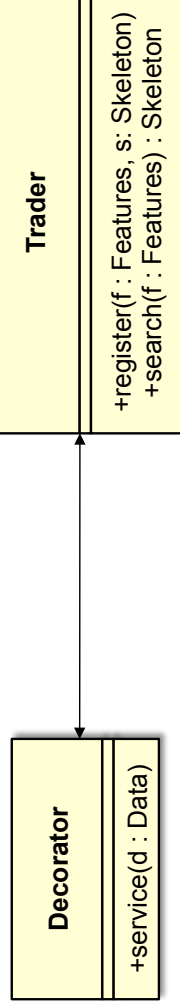

Remark: Skeletons, NameServers, and Containers

- ▶ Can be started and consulted by skeletons
- ▶ May offer many other aid functionality
- Transactions: consistent management of multiple clients and service requests
 - Security
 - Persistence
 - Interception (hooks into which new functionality can be entered)
 - Support for aspects





What Classical Component Systems Provide

- ▶ Technical support: remote, language and platform transparency
 - Stub, Skeleton
 - One per component (technique: IDL compiler)
 - Generic (technique: reflection and dynamic invocation)
 - Decorators on client and server site
 - Individual
 - Generic (technique: Name services)
- ▶ Economically support: reusable services
 - Basic: name, trader, persistency, transaction, synchronization
 - General: print, e-mail, ...
 - Domain specific: business objects, ...



Summary

- ▶ Component systems provide many component secrets
 - Location, language and platform transparency
 - Transactional, persistence, security, name service
- ▶ Component secrets are realized with the Connector Pattern (Stub, Skeleton-Pattern)
 - One pair or tuple of Decorators per component in a layer, but several layers, stacking Decorators on top of each others
 - On the server side, adapters help to make services generic
 - Decorators, Proxies, Adapters, Chains on client and server site
- ▶ Generated by IDL compiler
 - Is the IDL compiler essential?
 - No! Generic stubs and skeletons are possible, too. Technique: Reflective invocation



A More Simple Connector with Server Interface (Alt. 2, with Abstract Interface)

- ▶ Client and server are connected via a layer of stubs and skeletons (the *connector*)
- ▶ Server, Stubs and Skeletons inherit from same interface (not a Decorator!) → this cannot be layered

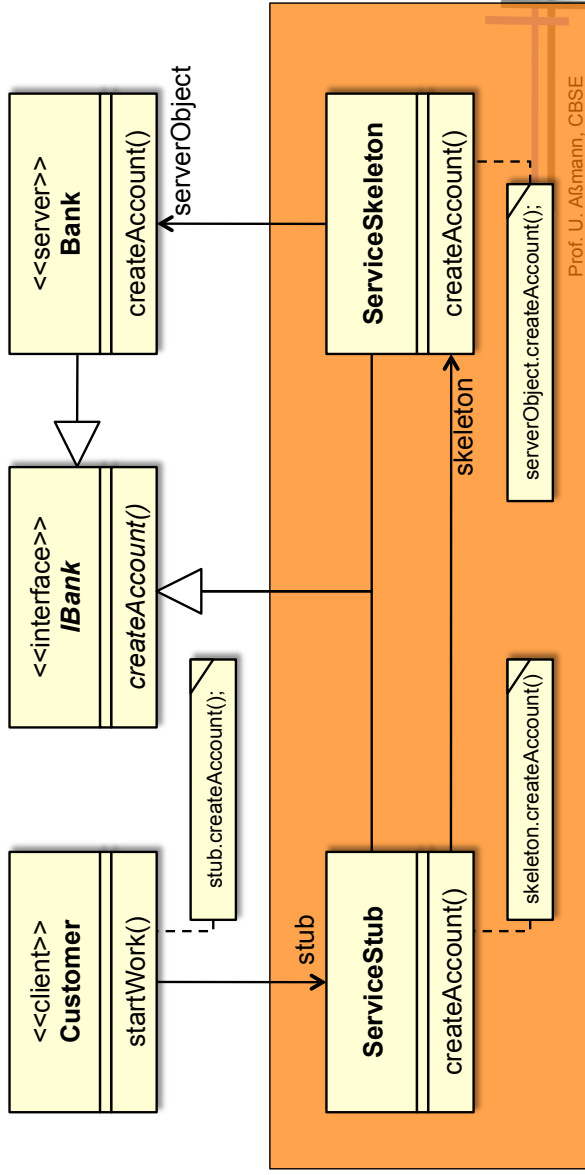

Appendix Example: A Remote Yellow Page Service

with remote access, serialization

For your own study

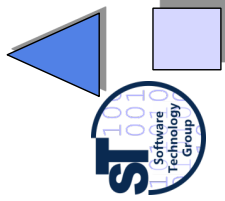



Remote Yellow Page Service

- Basic design without Serialization/Deserialization

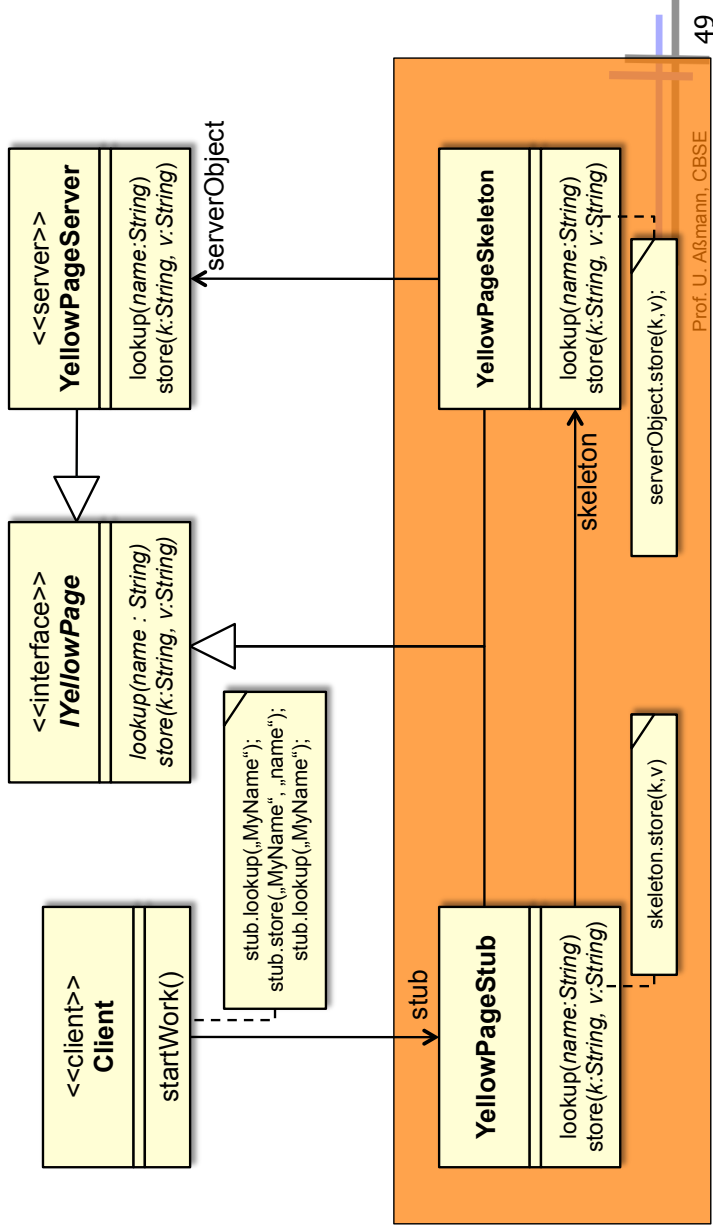

Remote Yellow Page Service

- With Serialization/Deserialization

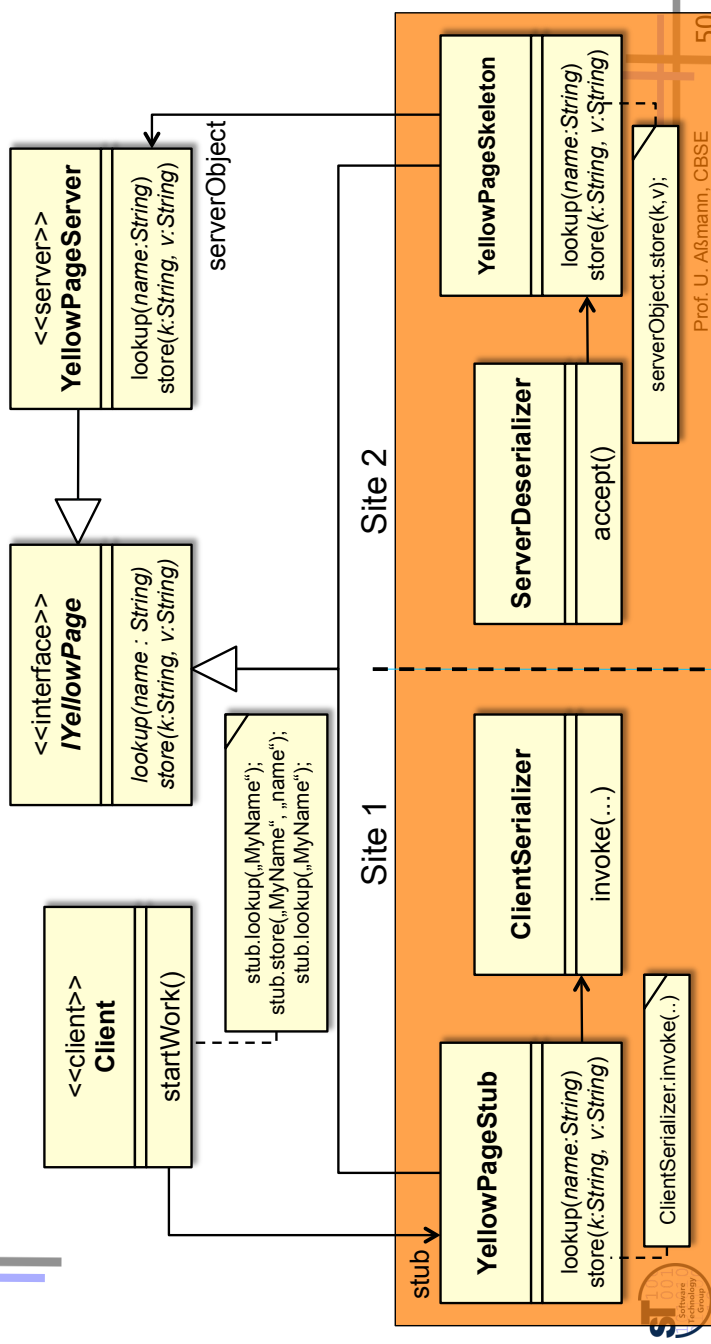



Service Interface

```
interface IYellowPageService {  
    String SERVICE_NAME = "Yellow Pages";  
    String lookup(String name);  
    void store(String name, String value);  
}
```



Service Implementation

```
class YellowPageService implements IYellowPageService {  
    private Hashtable<String, String> cache =  
        new Hashtable<String, String>();  
  
    private DataBaseis db = ...;  
  
    public String lookup(String name) {  
        String res = cache.get(name);  
        if (res == null)  
            res = db.lookup(name);  
        if (res != null) {  
            cache.put(name, res);  
        }  
        return res;  
    }  
  
    public void store(String name, String value) {  
        cache.put(name, value);  
        db.store(name, value);  
    }  
}
```



Client

- ▶ Wants to transparently use the Yellow Page service

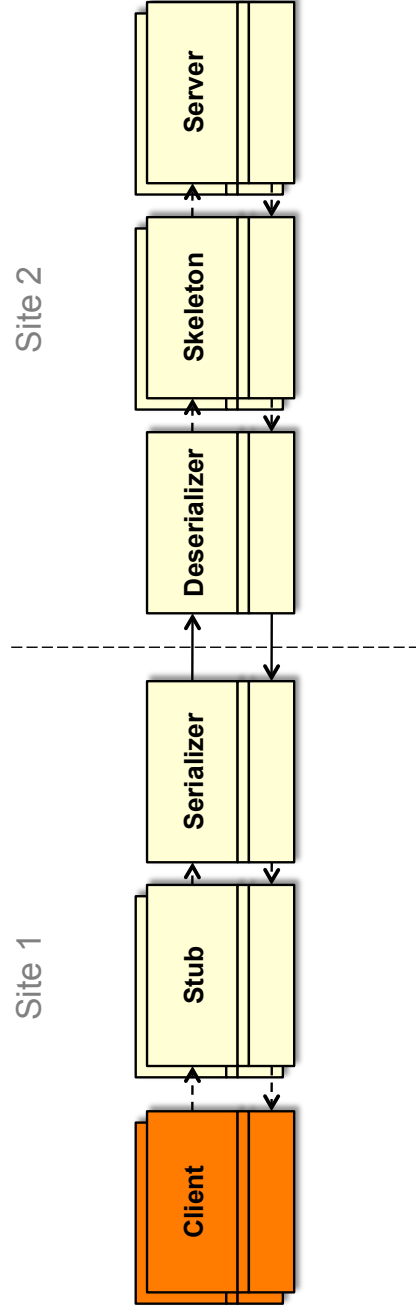

Example Client

- ▶ Client calls stub with service interface:

```
class Client {  
    ...  
    // returns client stub  
    IYellowPageService yps =  
        YellowPageFactory.create();  
    ...  
    String res = yps.lookup("MyName");  
    ...  
}  
  
class YellowPageFactory {  
    public IYellowPageService create() {  
        return new YellowPageStub ();  
    }  
}
```



Stub (client side)

- ▶ Realizes 1:1 mapping of client to service component
- ▶ Uses 1:1 mapping of clients to stubs

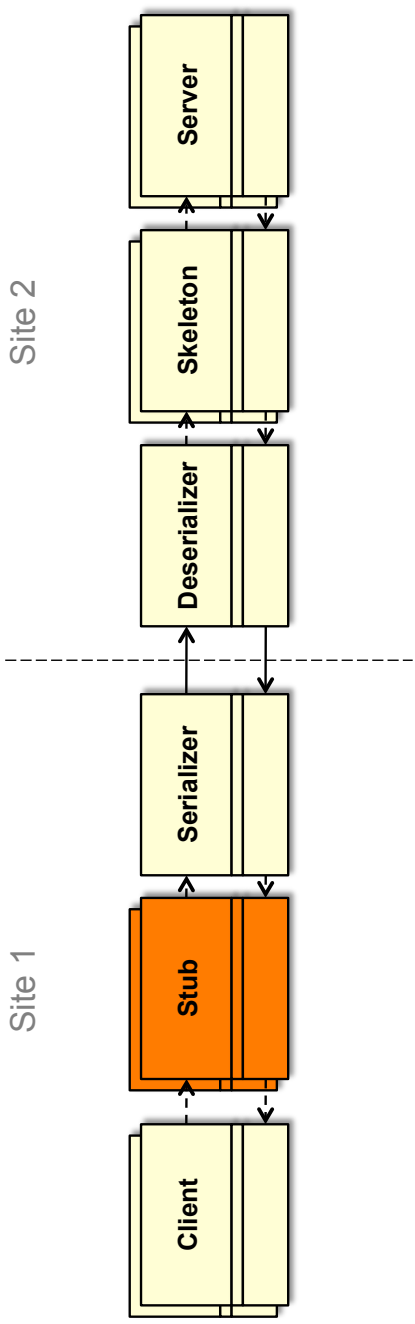

Example Client Stub - Implementation

```
class YellowPageStub implements IYellowPageService {
    private Integer logicalAddress = new Integer(-1);

    public YellowPageStub () {
        logicalAddress = (Object) ClientSerializer.invoke (
            IYellowPageService.SERVICE_NAME, logicalAddress, "new", null);
    }

    public String lookup (String name) {
        Object res = ClientSerializer.invoke (IYellowPageService.SERVICE_NAME,
            logicalAddress, "lookup", new Object[] {name});
        return (String) res;
    }

    public void store (String name, String value) {
        ClientSerializer.invoke (IYellowPageService.SERVICE_NAME,
            logicalAddress, "store", new Object[] { name, value });
    }
}
```

Scenario with Second Stub (client site)

- ▶ By using the Decorator pattern, stubs can be stacked onto each other
- ▶ Every stub solves another transparency problem (middleware concern)

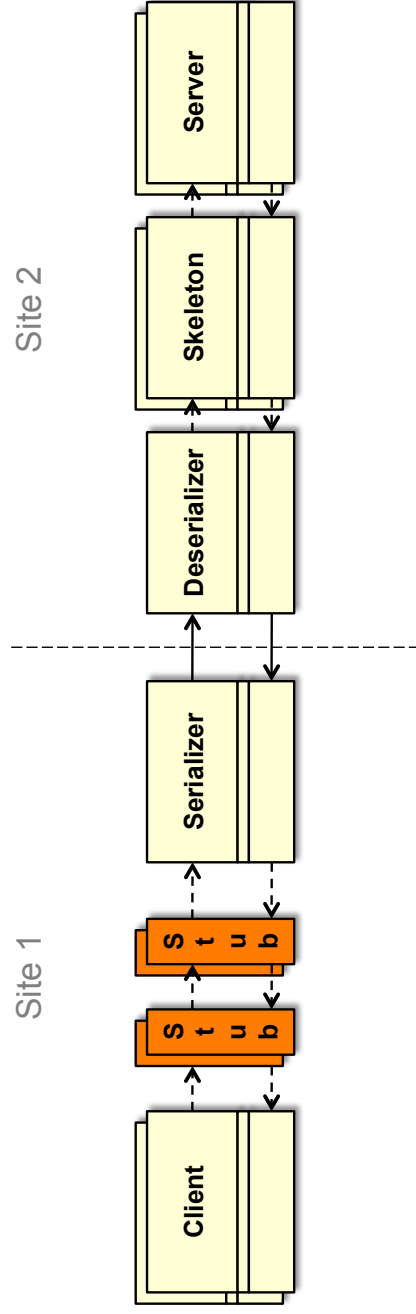

Client Stub 1 – This Time with Decorator Chain Implementation

```
// new stub: encryption decorator
class YellowPageStubEncryption implements IYellowPageService {
    private IYellowPageService clientDec;

    // Security: encryption, decryption
    private String encrypt(String name);
    private String decrypt(String name);

    // client-side constructor
    public YellowPageStubEncryption() {
        clientDec = new YellowPageStub();
    }

    // lookup function, with encryption, decryption
    public String lookup(String name) {
        String res = clientDec.lookup(encrypt(name));
        return decrypt(res);
    }

    // store
    // ...
}
```

Client-side Serializer

- ▶ Manages the basic communication on client side
- ▶ Is called from the client stubs
- ▶ Can be hidden in a Decorator (1:1), but can be also shared by all stubs

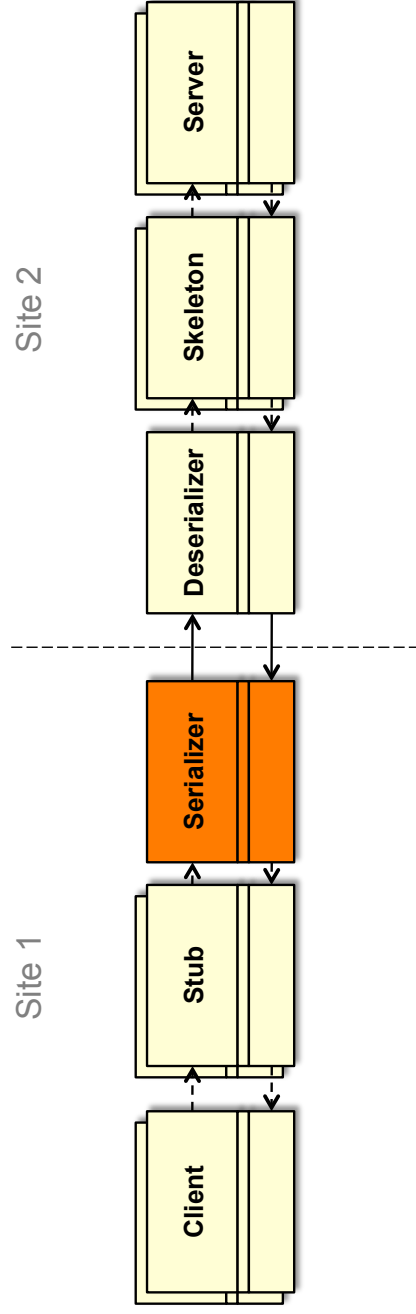

Example Client Serializer

```
class ClientSerializer {
    public static Object invoke(String service, Integer address,
                               String method, Object[] args) {
        Socket s = new Socket("yp-st.inf.tu-dresden.de", 1234);
        ObjectOutputStream os = new ObjectOutputStream(s.getOutputStream());
        ObjectInputStream is = new ObjectInputStream(s.getInputStream());
        os.writeObject(service);
        os.writeObject(address);
        os.writeObject(method);
        if (args != null) {
            os.writeObject(args);
        }
        os.flush();
        Object result = is.readObject();
        s.close();
        return result;
    }
}
```

Server-side Deserializer

- ▶ Manages the basic communication on server side
- ▶ Calls the service skeletons (1:n mapping)

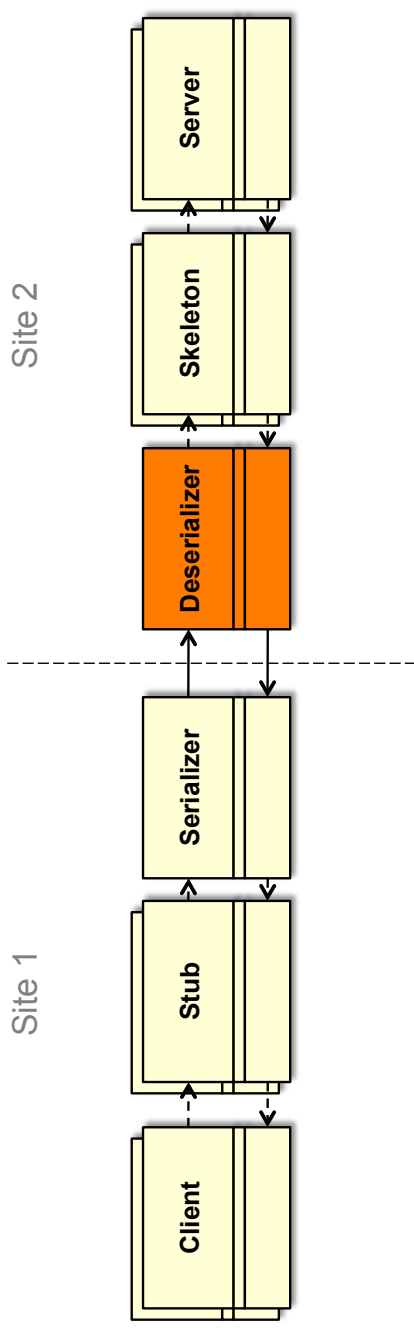

Example Server Deserializer (1)

- ▶ Deserializer listens on the network is shared between different services
 - interprets incoming service names
 - can create/invoke several service skeletons (yellow page, phone book, ..)
 - lives always, but hides lifetime of the server

```
class ServiceDeserializer {
    public void run() {
        ServerSocket server = new ServerSocket(1234);
        while (true) {
            Socket client = server.accept();
            ObjectInputStream is = new ObjectInputStream(client.getInputStream());
            ObjectOutputStream os = new ObjectOutputStream(client.getOutputStream());
            String service = (String) is.readObject();
            if (service.equals(IYellowPageService.SERVICE_NAME)) {
                handleYellowPage(os, is);
            } else if (service.equals(IPhoneBook.SERVICE_NAME)) {
                handlePhoneBook(os, is);
            } else {
                System.err.println("Unknown service.");
            }
        }
    }
}
```

Example Server Deserializer (2)

```
private void handleYellowPage(ObjectOutputStream os, ObjectInputStream is) {
    Integer address = (Integer) is.readObject();
    if (address == -1) { // creation of the service
        YellowPageSkeleton skeleton = new YellowPageSkeleton();
        os.writeObject(skeleton.getLogicalAddress());
    } else { // service query: interpretation of the symbolic service name
        IYellowPageService yp = new YellowPageSkeleton(address);
        String method = (String) is.readObject();
        Object[] args = (Object[]) is.readObject();
        if (method.equals("lookup")) {
            String res = yp.lookup((String)args[0]); // finally: call the service
            os.writeObject(res);
        } else if (method.equals("store")) {
            yp.store((String)args[0], (String)args[1]);
            os.writeObject(null);
        } else
            System.err.println("Unknown service method.");
    }
    os.flush();
}}
```

Skeleton (Server side)

- ▶ Manages service components of server on server side
- ▶ 1:1 mapping to service component

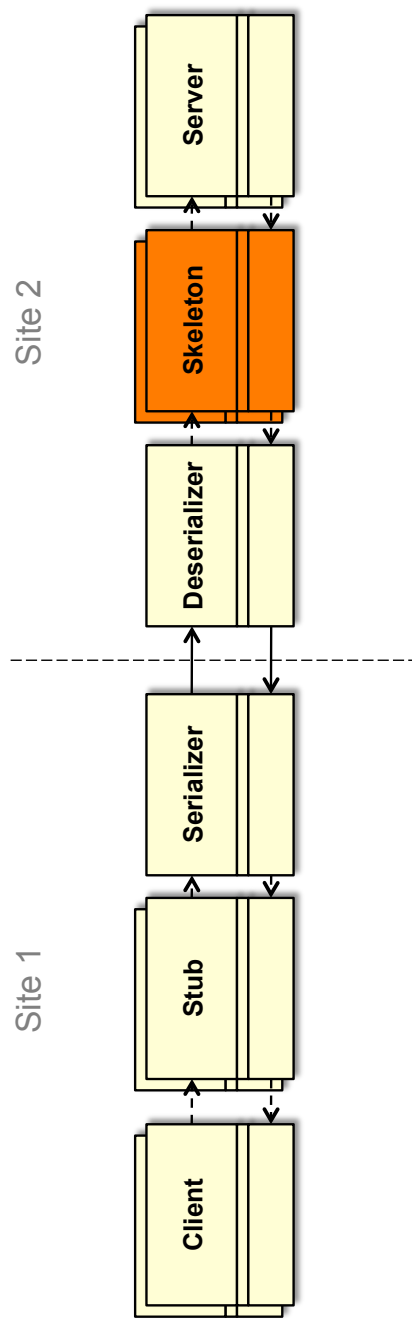

Example Yellow Pages Server Skeleton (Service Lookup and Call, Adapter)

```
public class YellowPageSkeleton implements IYellowPageService {
    private static Hashtable<Integer, IYellowPageService> yellowPageServices =
        new Hashtable<Integer, IYellowPageService>();
    private Integer logicalAddress;
    public YellowPageSkeleton() {
        this(new Integer(yellowPageServices.size()));
        yellowPageServices.put(logicalAddress, new YellowPageService());
    }
    public YellowPageSkeleton(Integer address) {
        logicalAddress = address;
    }
    public Integer getLogicalAddress() { return logicalAddress; }
    public String lookup(String name) {
        IYellowPageService service = yellowPageServices.get(logicalAddress);
        return service.lookup(name);
    }
    public void store(String name, String value) {
        IYellowPageService service = yellowPageServices.get(logicalAddress);
        service.store(name, value);
    }
}
```



Creation of YP Service

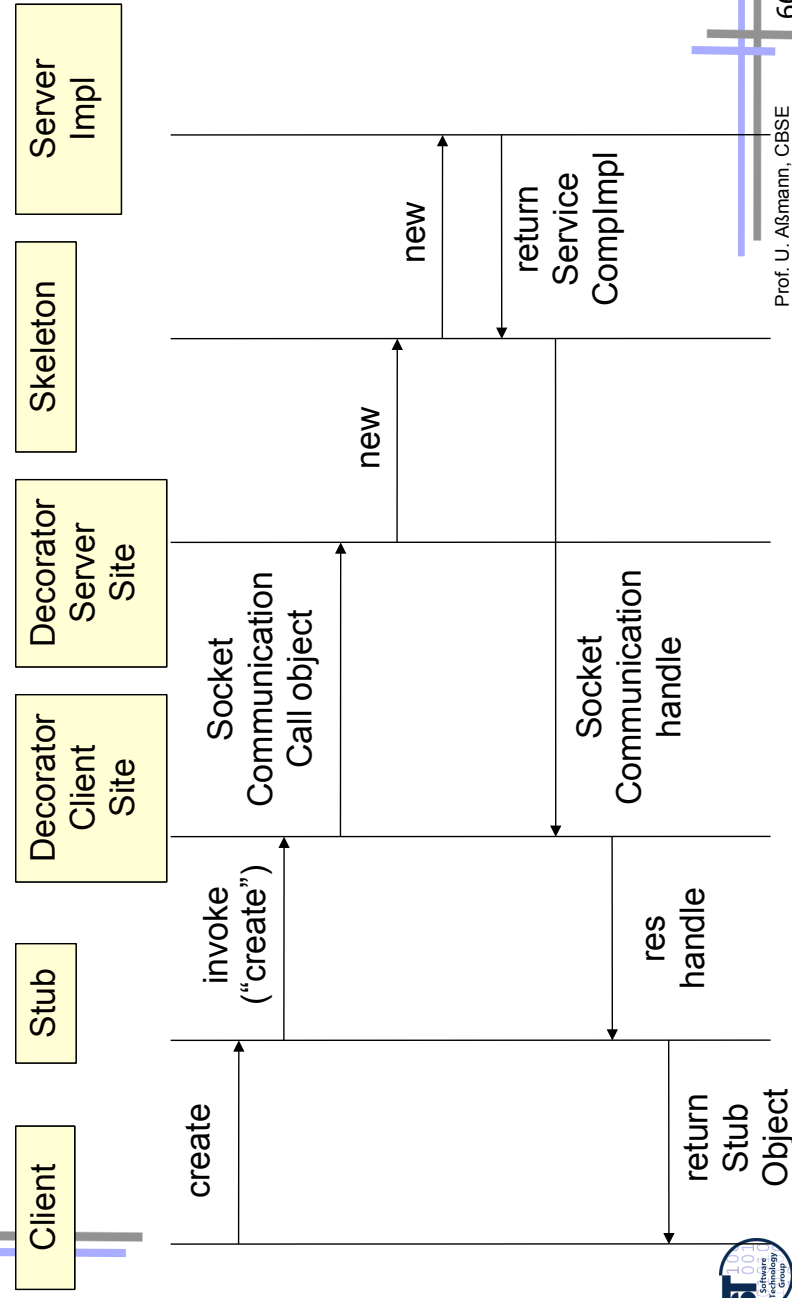

Call (Lookup) YP Service

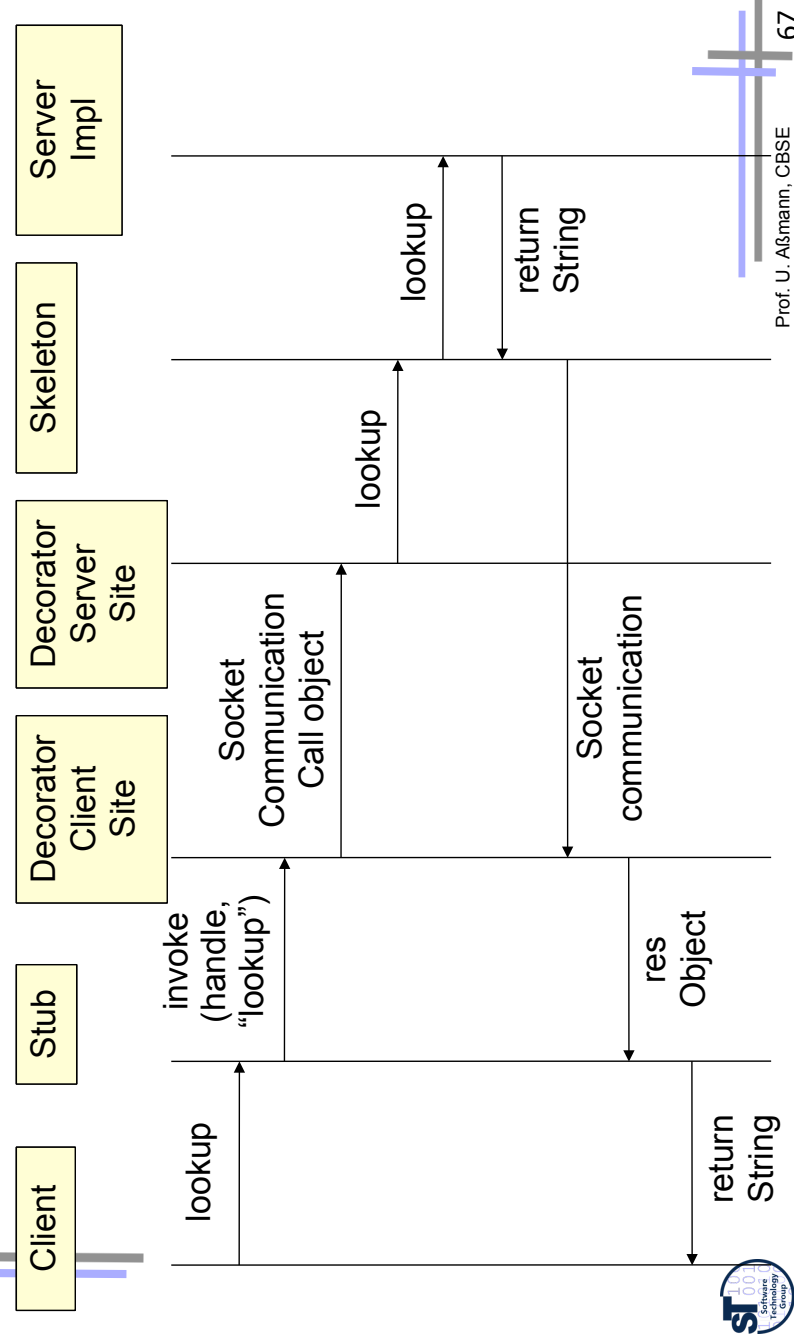

Prof. U. Alsmann, CBSE

67

Appendix B Generic Skeletons

Mapping names to locations by name servers

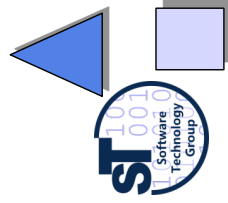

CBSE, © Prof. Uwe Alsmann

68

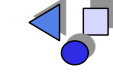

Rept.: Reflection & Reflective Invocation

- ▶ Reflection
 - to inspect the interface of an unknown component
 - for automatic/dynamic configuration of server sites
 - to call the inspected components
- ▶ Access to interfaces with IDL
 - Standardize an IDL run time representation and access
 - Define a IDL specification for IDL representation and access
 - Store IDL specifications in *interface repositories* which can be introspected



Example Generic Skeleton (Reflective Skeleton)

- ▶ A **generic skeleton** is a special case of a name service: using reflection to look up the name for a method

```
class ReflectiveSkeleton {
    // serverObjects is the server implementation repository
    static ExtendedHashtable serverObjects = new ExtendedHashtable();
    ObjectOutputStream os;
    ObjectInputStream is;

    ...
    public Object handleGeneric() { ...
        Integer addr= (Integer) is.readObject();//handler
        String mn = (String) is.readObject();//method name
        Class[] pt = (Class[]) is.readObject();//parameter types
        Object[] args= (Object[]) is.readObject();//parameters

        // get server object reference by reflective call to implementation repository
        Object o      = serverObjects.getComponent(addr);
        Method m      = o.getClass().getMethod(mn,pt); //method object by
        reflection
        Object res     = m.invoke(o,args);          //method call by
        reflection
        os.writeObject(res);
        os.flush();
    } ...
}
```



Appendix C

The Decorator Design Pattern

(Repetition from DPF in winter)

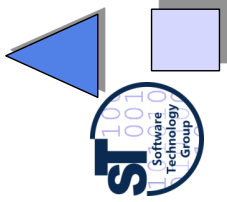

CBSE, © Prof. Uwe Aßmann

71

Decorator Pattern

- ▶ A Decorator is a *skin* of another object
- ▶ It is a 1-ObjectRecursion (i.e., a restricted Composite):
 - A subclass of a class that contains an object of the class as child
 - However, only one composite (i.e., a delegatee)
- ▶ Combines inheritance with aggregation
 - Inheritance from an abstract Handler class
 - That defines a contract for the mimiced class and the mimicing class

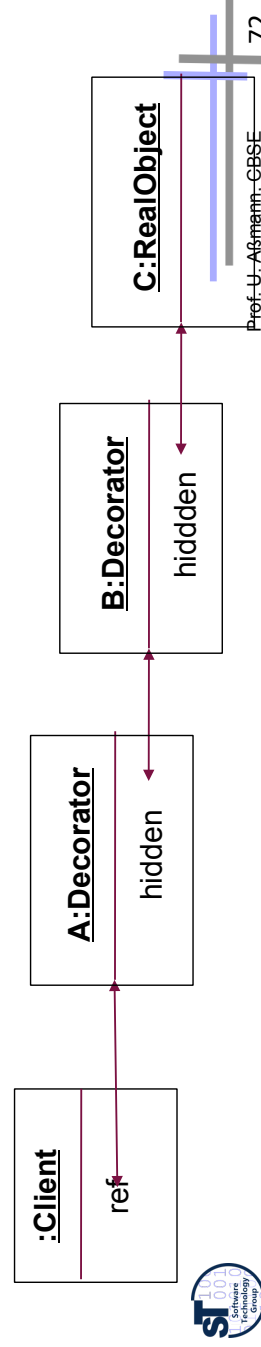

Prof. U.-Aßmann, CBSE

72

Decorator – Structure Diagram

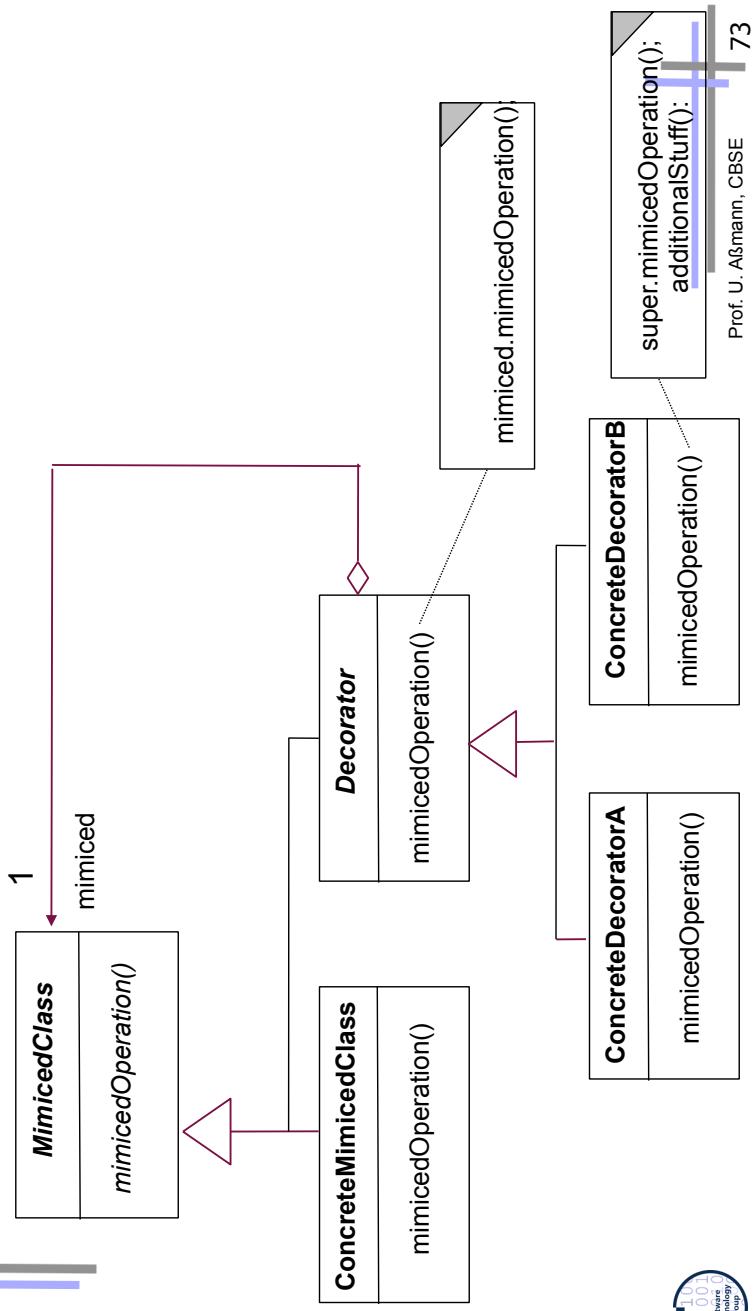

Example: Decorator for Widgets

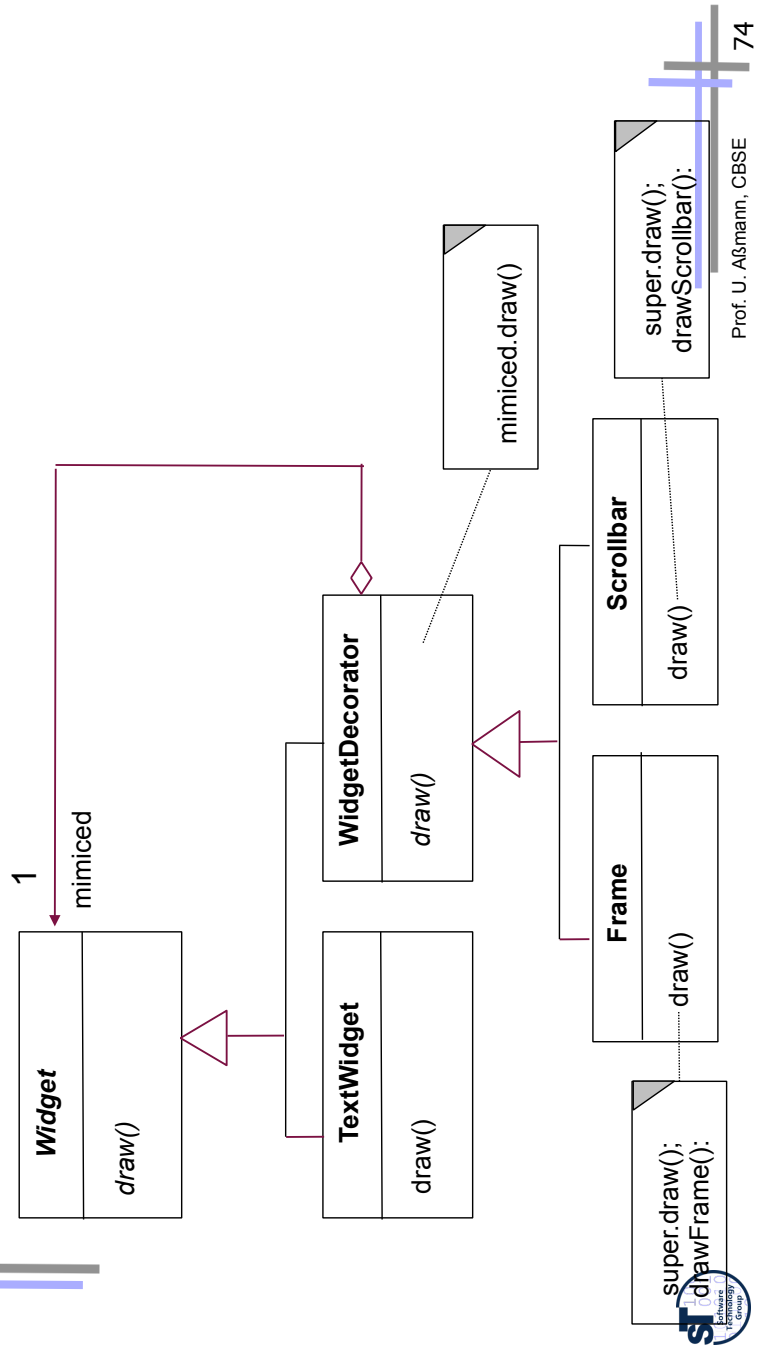

Decorator for Persistent Objects

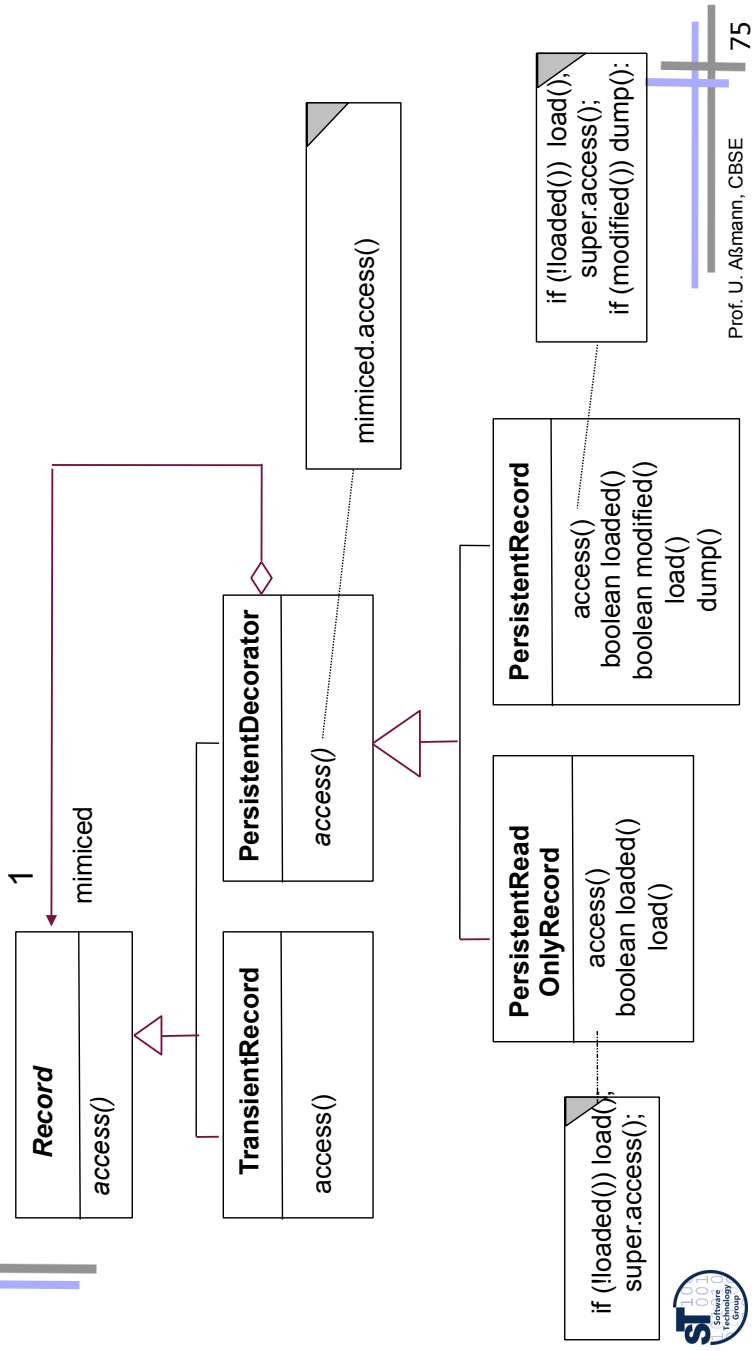

Purpose Decorator

- ▶ For extensible objects (i.e., decorating objects)
 - Extension of new features at runtime
 - Removal possible
- ▶ Instead of putting the extension into the inheritance hierarchy
 - If that would become too complex
 - If that is not possible since it is hidden in a library

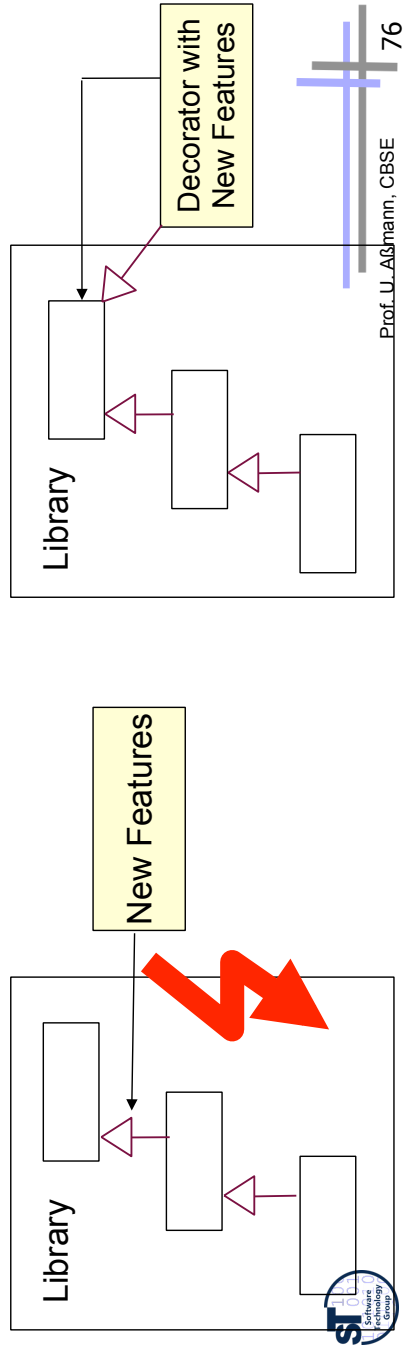

Variants of Decorators

- ▶ If only one extension is planned, the abstract super class Decorator can be omitted; a concrete decorator is sufficient
- ▶ Decorator family: If several decorators decorate a hierarchy, they can follow a common style and can be exchanged together
- ▶ Decorators can be chained to each other
- ▶ Dynamically, arbitrarily many new features can be added

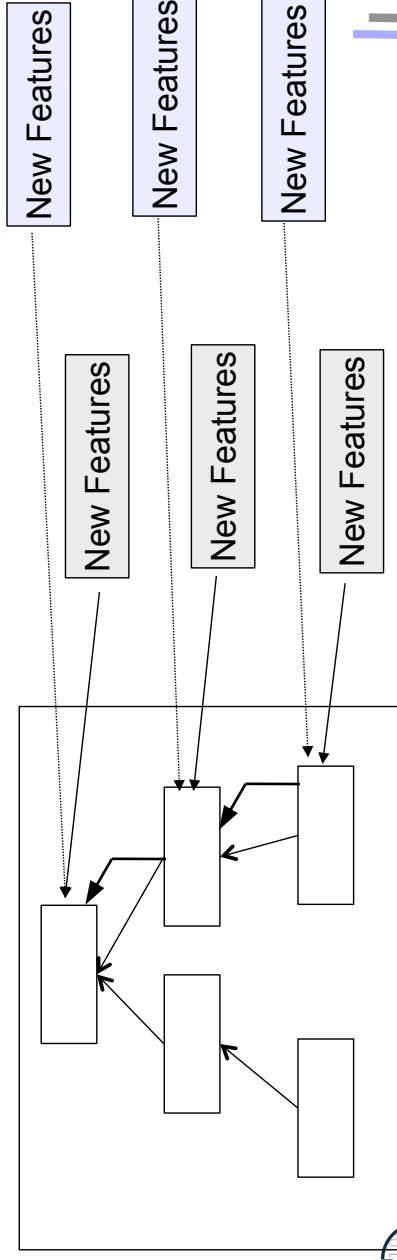

The End

- ▶ Many slides courtesy to Prof. Welf Löwe, Växjö University, Sweden.