

# 24. Entwurfsmuster für Produktfamilien

Prof. Dr. Uwe Aßmann

Lehrstuhl Softwaretechnologie

Fakultät für Informatik

TU Dresden

19-0.2, 5/11/19

- 1) Patterns for Variability
- 2) Patterns for Extensibility
- 3) Patterns for Glue
- 4) Other Patterns
- 5) Patterns in AWT

Achtung: Dieser Foliensatz ist teilweise in Englisch gefasst, weil das Thema in der Englisch-sprachigen Kurs “Design Patterns and Frameworks” (WS) wiederkehrt. Mit der Bitte um Verständnis.



# Obligatory Literature

2

Softwaretechnologie (ST)

- ▶ ST für Einsteiger, Kap. Objektentwurf: Wiederverwendung von Mustern
- ▶ also: Chap. 8, Bernd Brügge, Allen H. Dutoit. Objektorientierte Softwaretechnik mit UML, Entwurfsmustern und Java. Pearson.

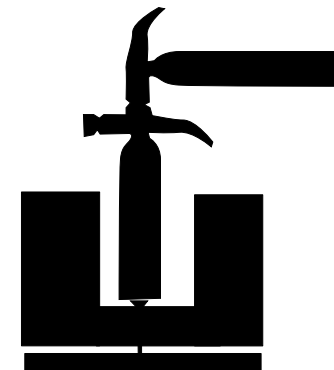
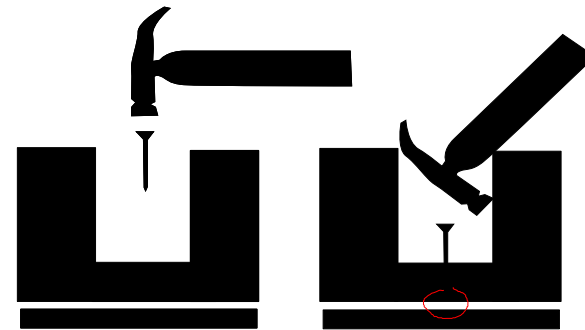

# Standard Problems to Be Solved By *Product Line Patterns*

- ▶ **Product Line Patterns** are specific design patterns about:
- ▶ **Variability: Exchanging parts easily**
  - Variation, variability, complex parameterization
  - Static and dynamic
  - For product lines, framework-based development
- ▶ **Extensibility: Add new features**
  - Software must change
- ▶ **Glue: Adapt to overcome architectural mismatches**
  - Coupling software that was not built for each other

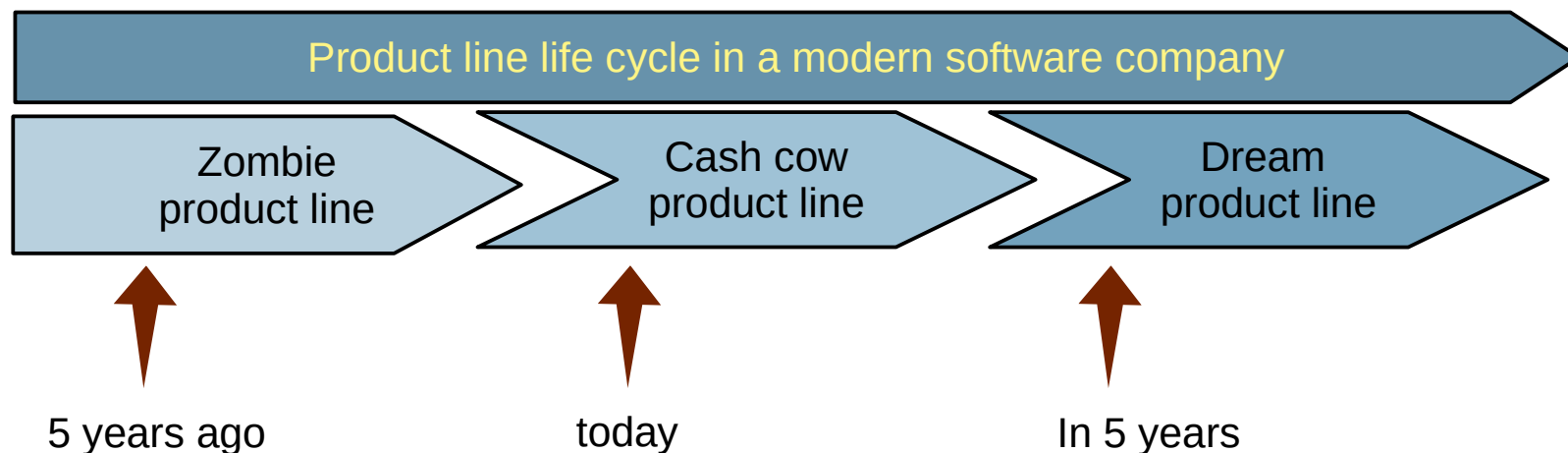

## 24.1) Patterns for Variability

Variability Pattern	# Run-time objects	Key feature
TemplateMethod	1	
FactoryMethod	1	
TemplateClass	2	Complex object
Strategy	2	Complex algorithm object
FactoryClass	3	Complex allocation of a family of objects
Bridge (DimensionalClass Hierarchy)	2	Complex object



# Commonalities and Variabilities

- ▶ A variability design pattern describes
  - Code *common* to several applications
    - Commonalities lead to *frameworks of product lines*
  - Code *different or variable* from application to application
    - Variabilities to *products* of a product line
- ▶ For capturing the communality/variability knowledge in variability design patterns, Pree invented the *template-and-hook (T&H) concept*
  - *Templates* contain skeleton code (commonality), common for the entire product line
  - *Hooks (hot spots)* are placeholders for the instance-specific code (variability)

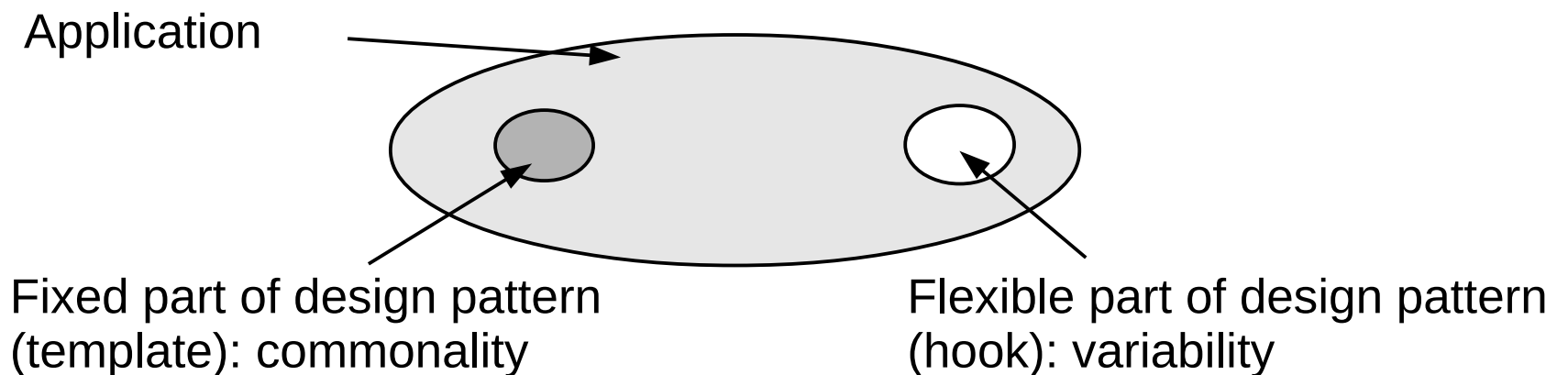

# Why Do We Need Variability?

- ▶ Functional features, packages (payed vs free use), etc
- ▶ Platforms (Hardware, operating system, database, GUI package, etc.)
- ▶ Dynamic contexts (personalization, time and location)

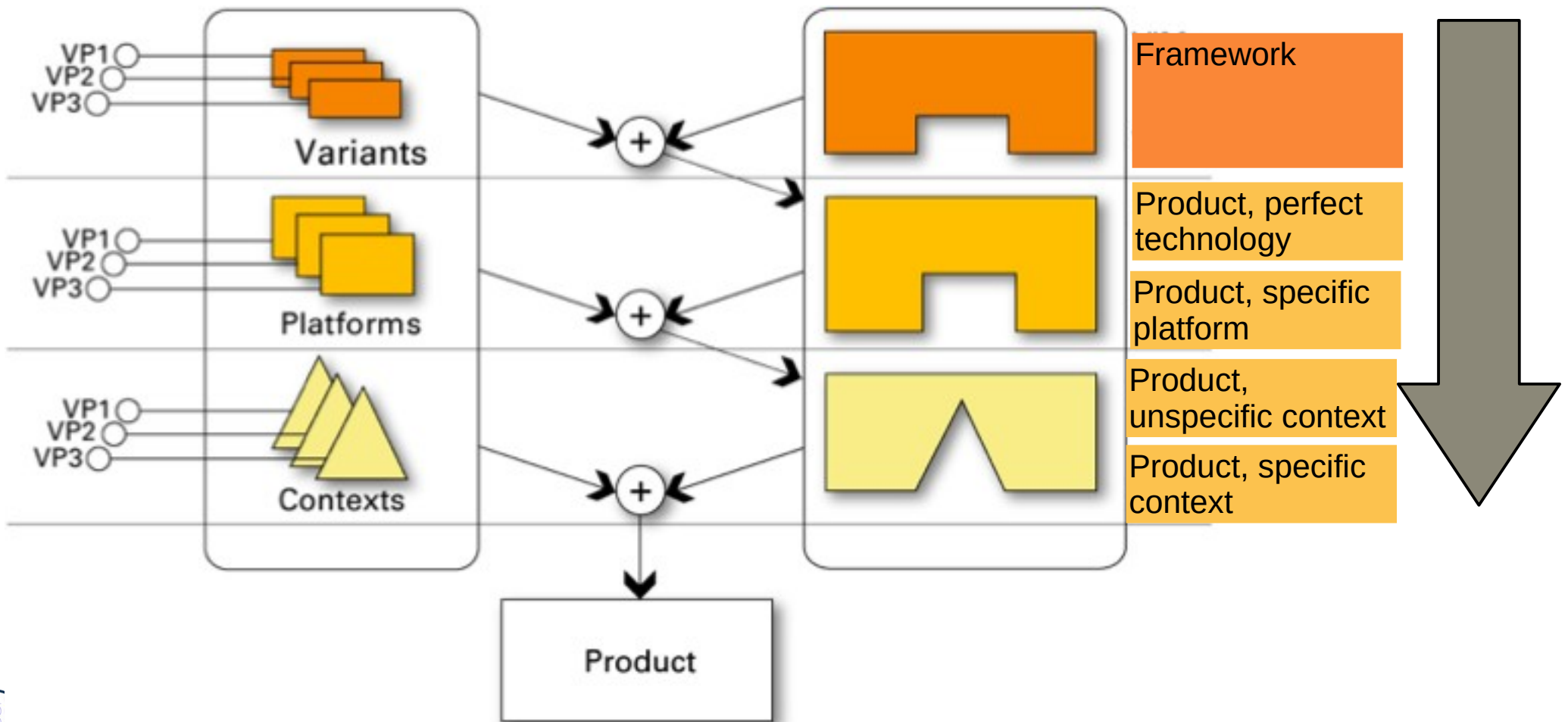

# TemplateMethod Pattern is a Variability Design Pattern (Rpt.)

- ▶ Define the skeleton of an algorithm (template method)
  - The template method is concrete
- ▶ Delegate parts to abstract *hook methods* that are filled by subclasses
- ▶ Implements template and hook with the same class, but different methods
- ▶ Allows for varying behavior
  - Separate invariant from variant parts of an algorithm
- ▶ Example: TestCase in JUnit

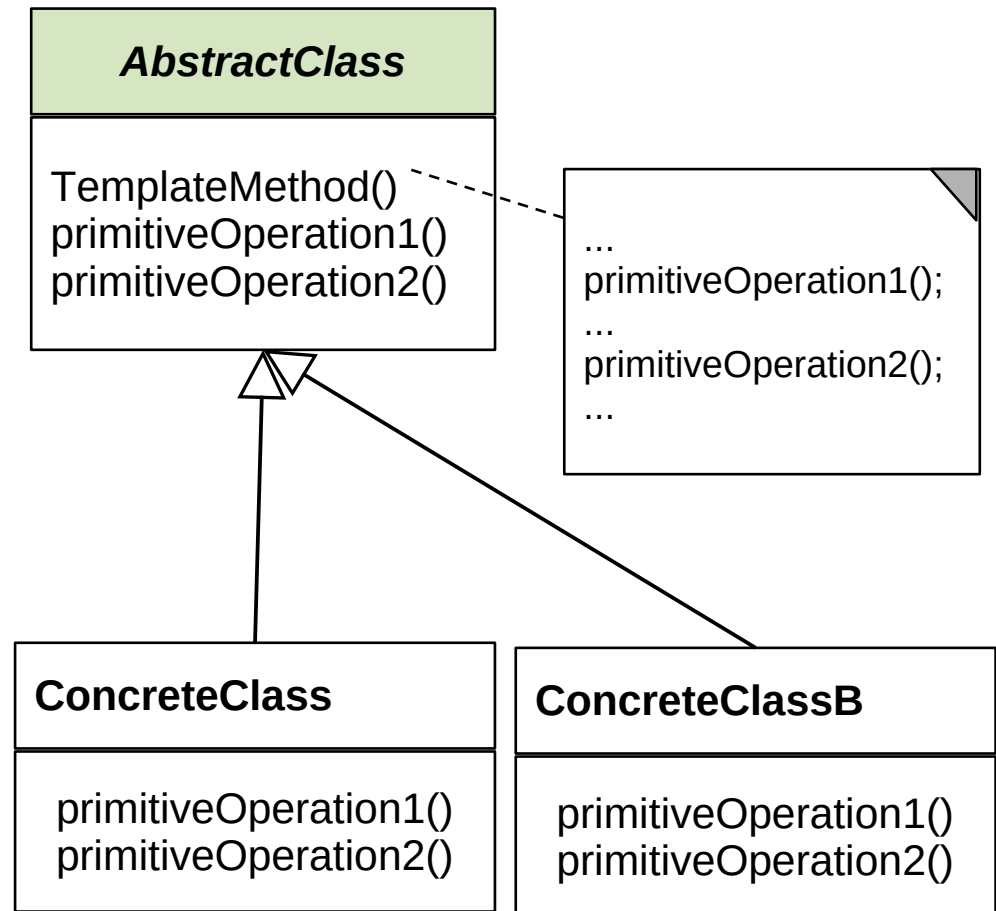

# Actors and Genres as Template Method

- ▶ Binding an Actor's hook to be a ShakespeareActor or a Comedy Actor
- ▶ The behavior visible to a client will differ in two aspects, reciting and dancing

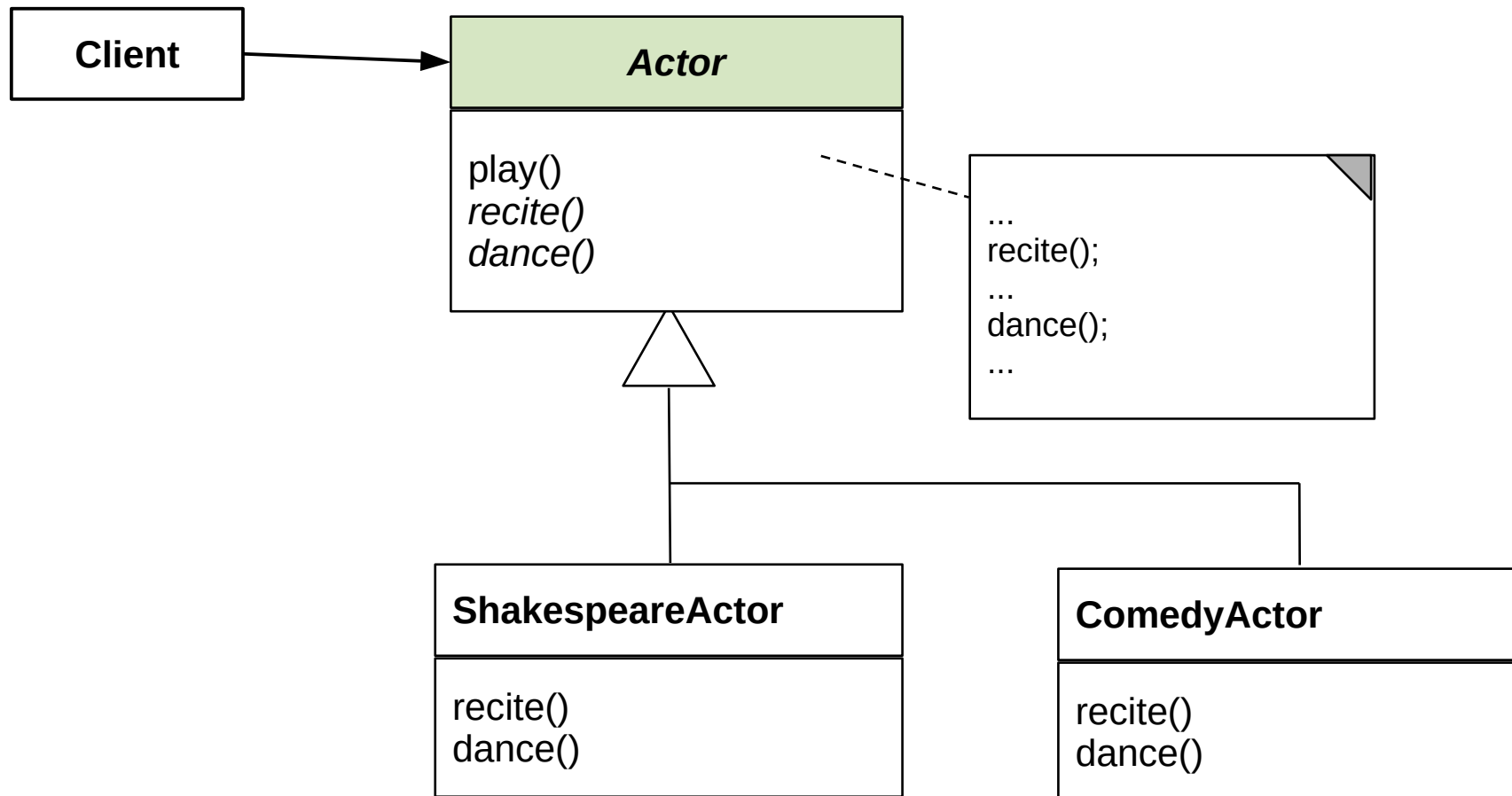



# Running Example: A Data Generator

- ▶ Parameterizing a data generator by frequency and kind of production

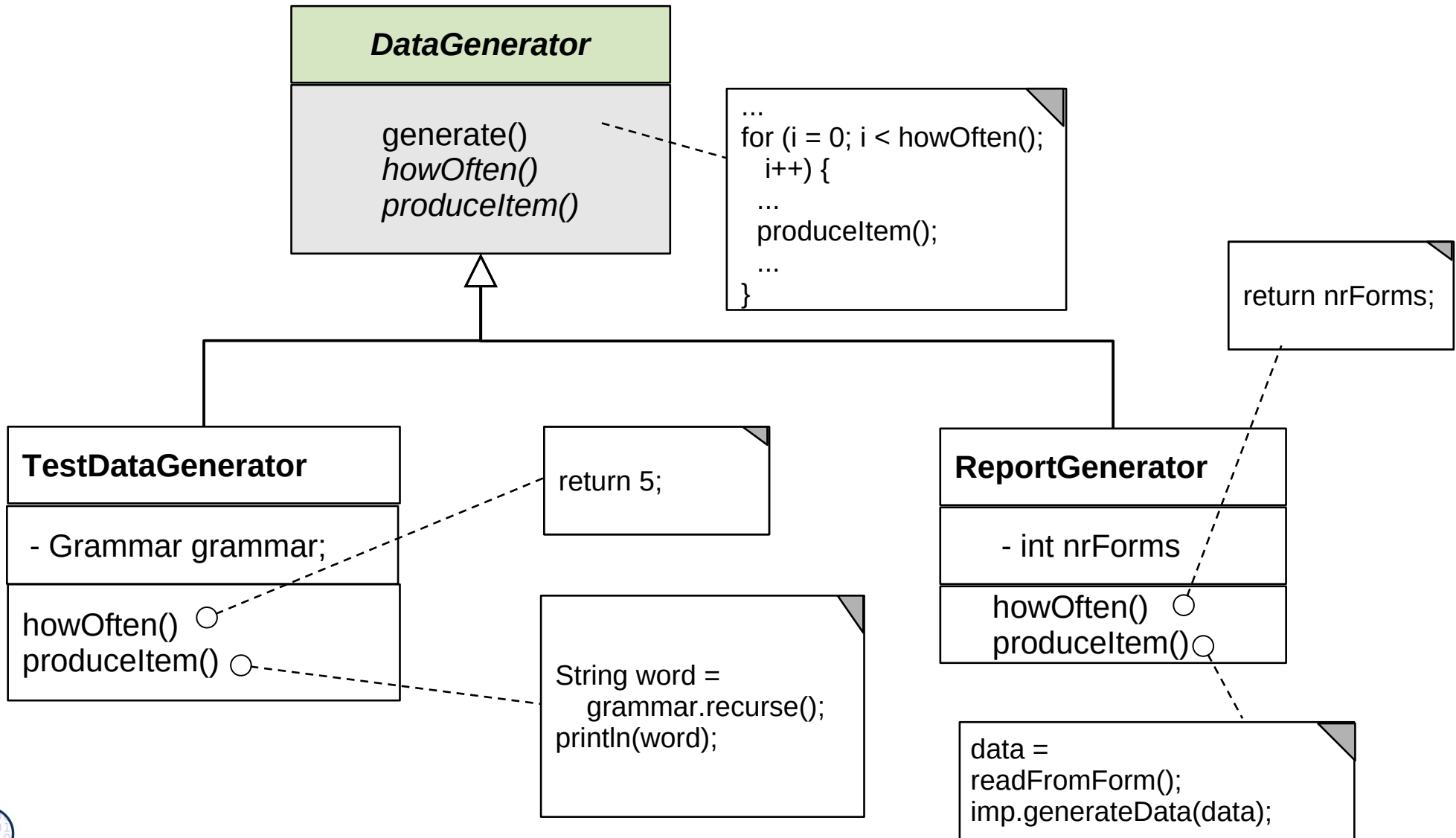

# Variability with TemplateMethod

- ▶ **Binding the hook method(s)** means to
  - Derive a concrete subclass from the abstract superclass, providing their implementation
- ▶ **Controlled variability** by only allowing for binding hook methods, but not overriding template methods

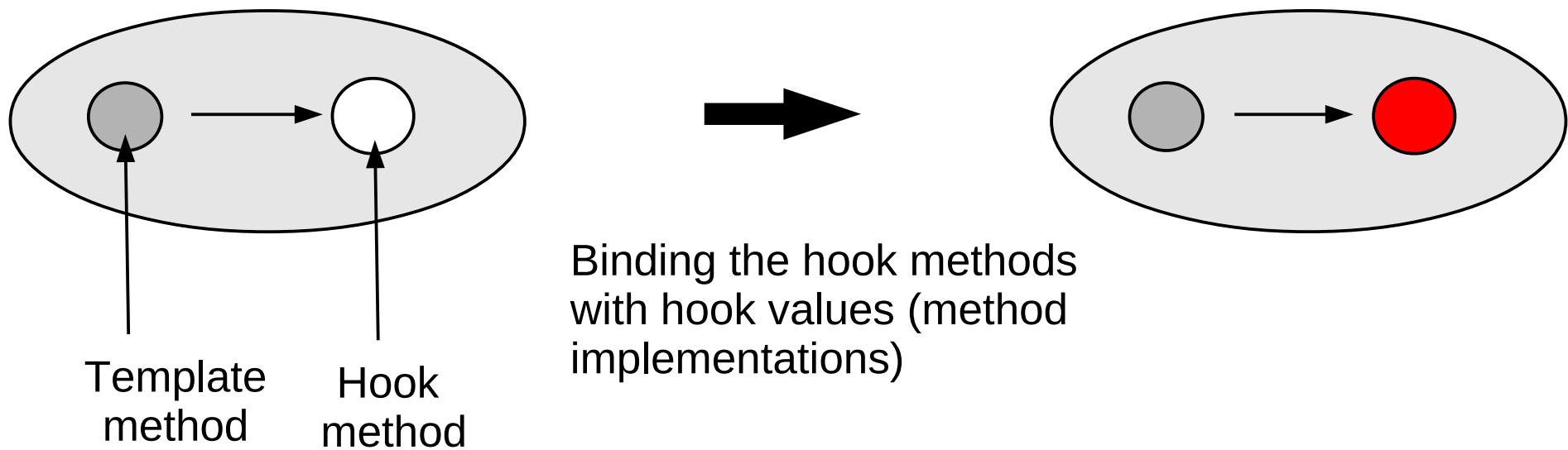

## 24.1.2 FactoryMethod (Rpt.)

- ▶ FactoryMethod is a variant of TemplateMethod
- ▶ A FactoryMethod is a polymorphic constructor

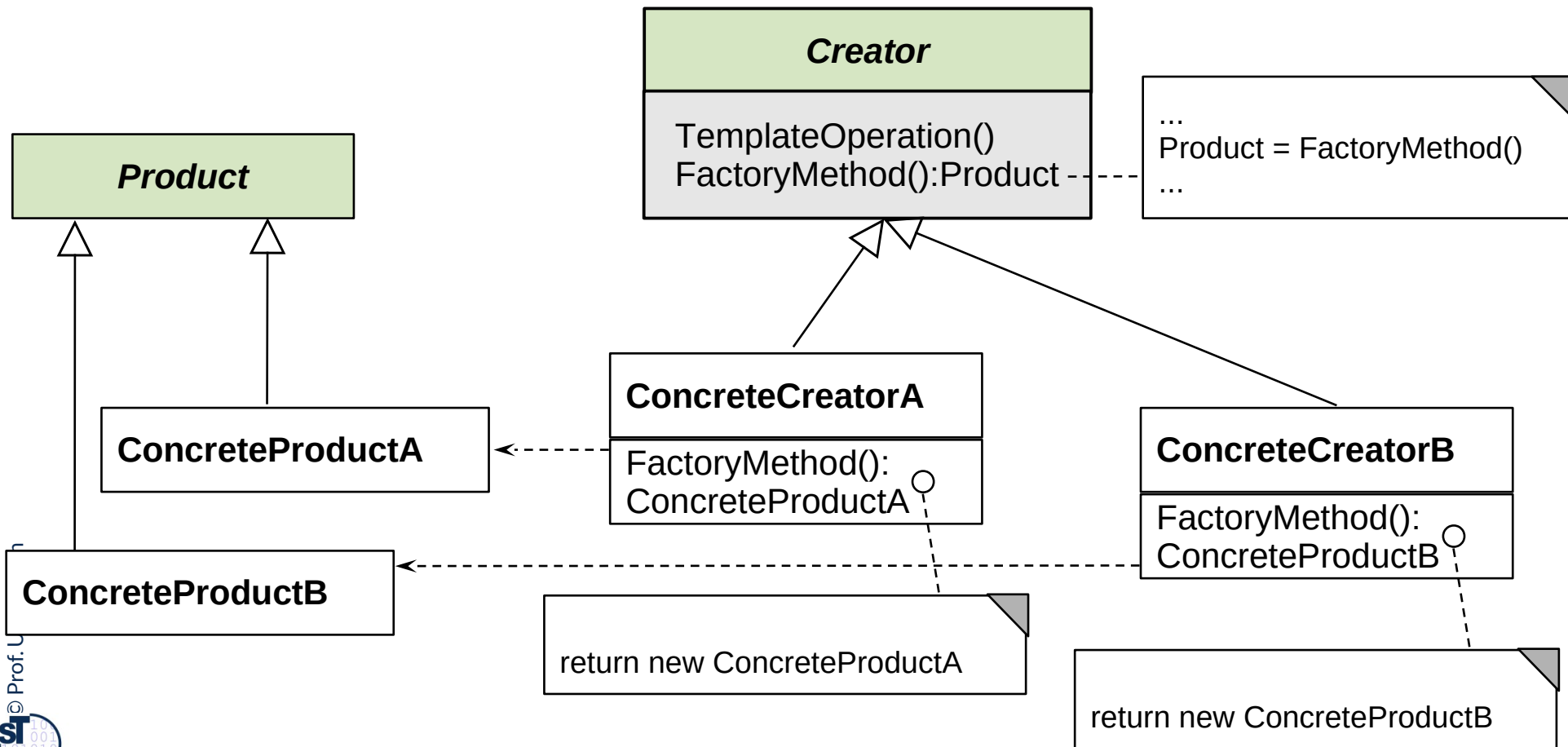

## 24.1.3 Strategy (Template Class)



# Strategy (also called Template Class)

- ▶ The template method and the hook method are found in different classes
- ▶ Similar to TemplateMethod, but
  - Hook objects and their hook methods can be exchanged at run time
  - Exchanging several methods (a set of methods) at the same time
  - Consistent exchange of several parts of an algorithm, not only one method
- ▶ This pattern is basis of Bridge, Builder, Command, Iterator, Observer, Visitor.

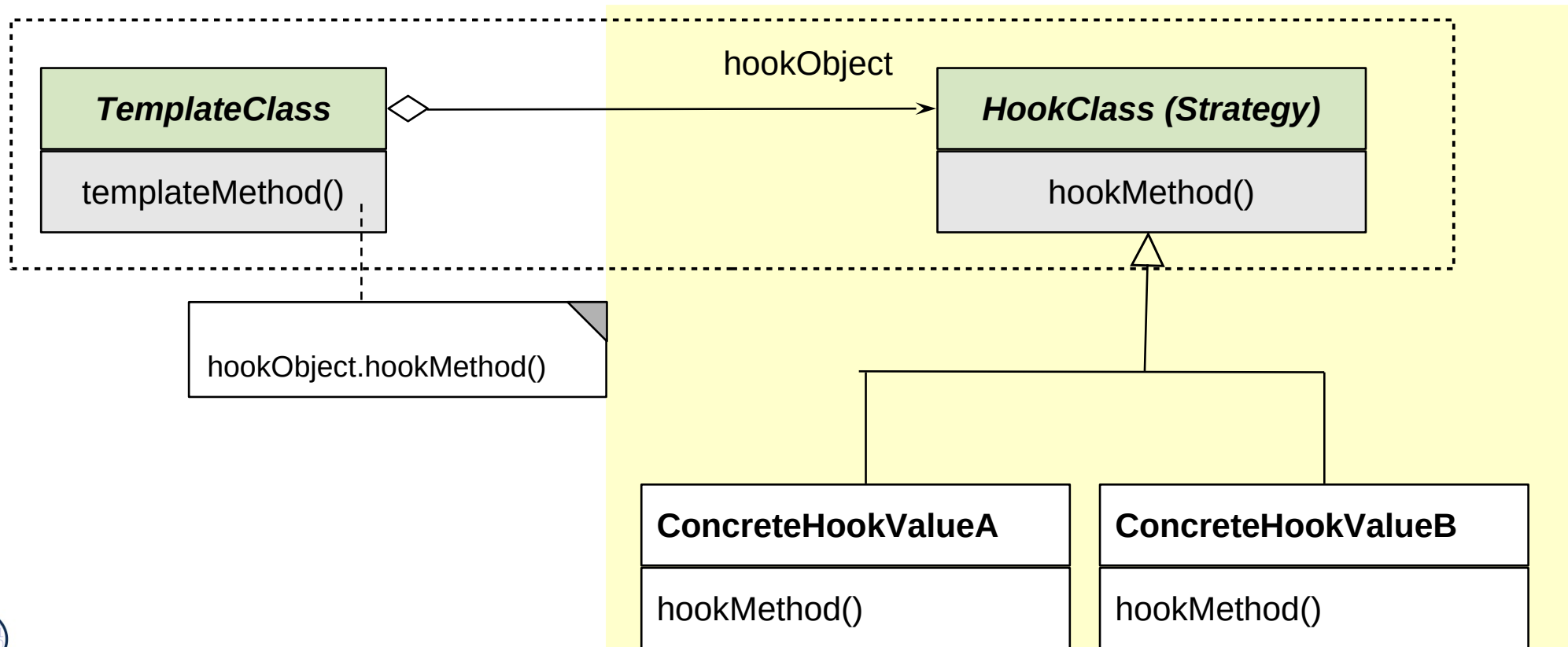

# Actors as Template Method

- ▶ TemplateMethod creates *one* run-time object; TemplateClass creates *two physical objects belonging to one logical object*

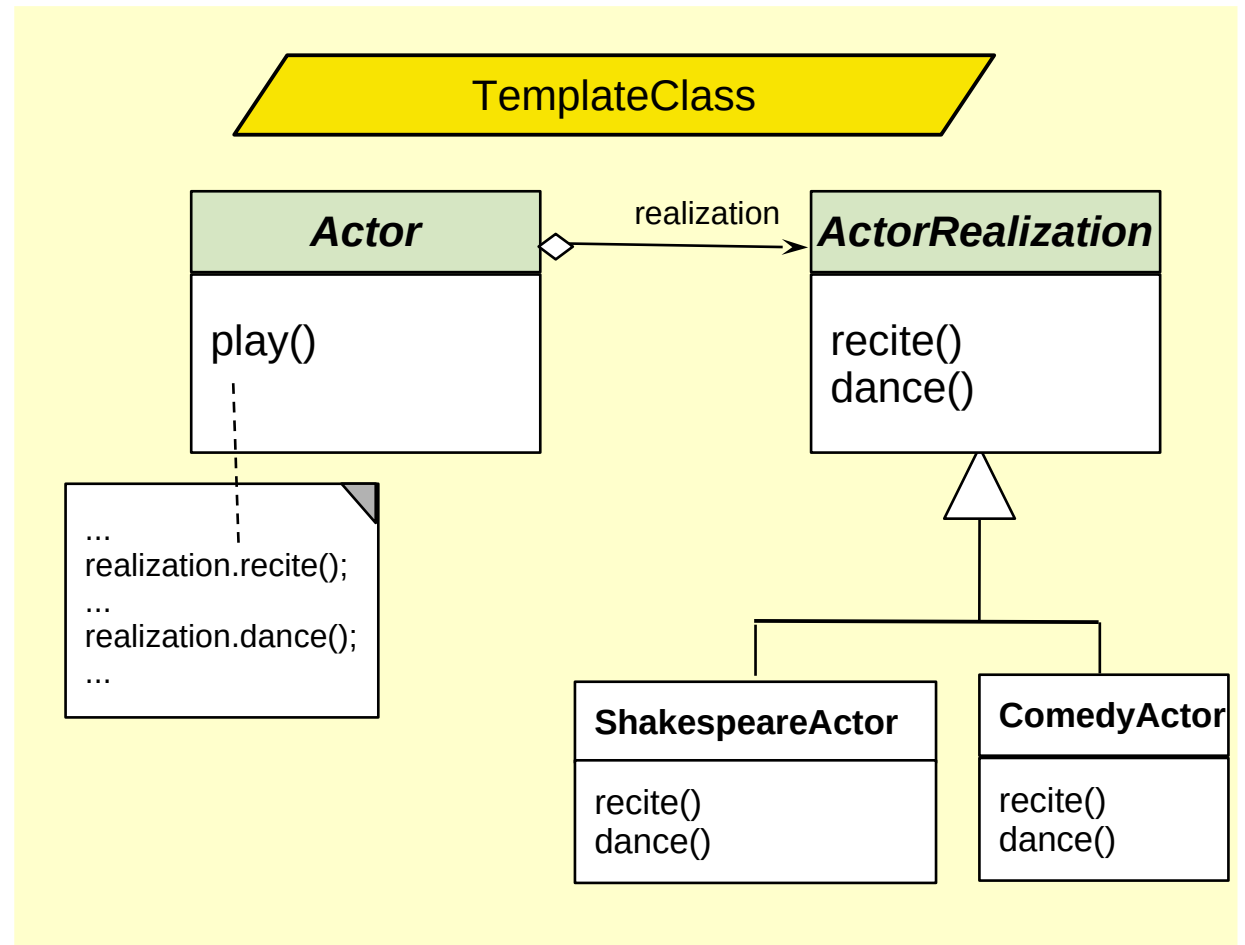
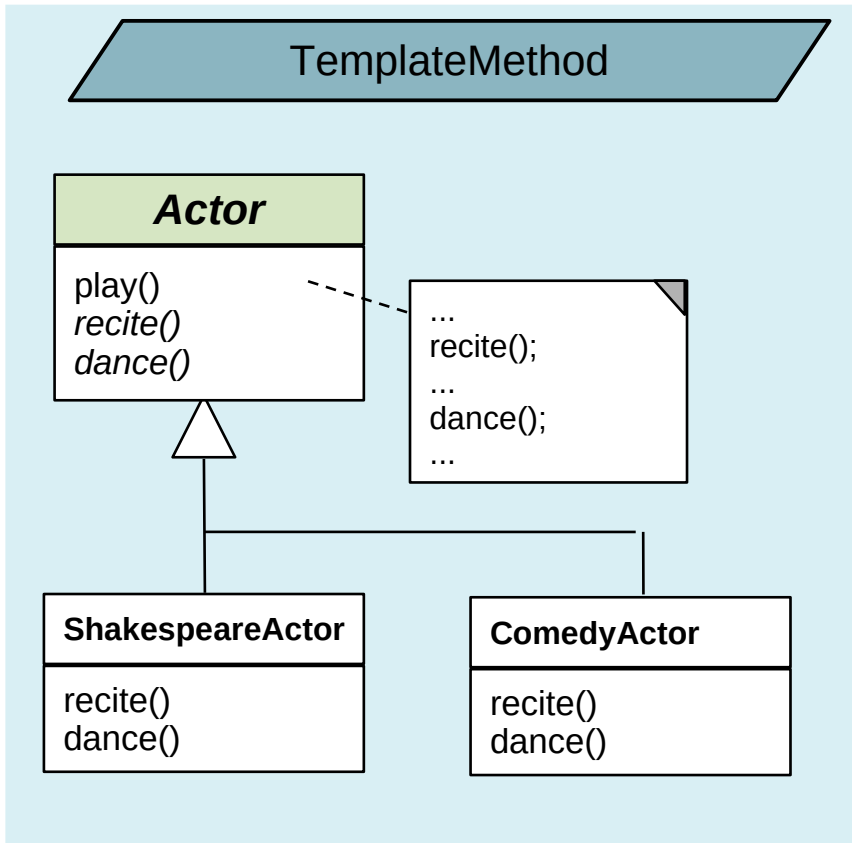

# Example for Strategy

- ▶ Strategy represents an algorithms as object (but Command calls it execute ( ))
- ▶ Ex.: complex formatting algorithm
- ▶ Strategy objects are often subobjects of complex objects

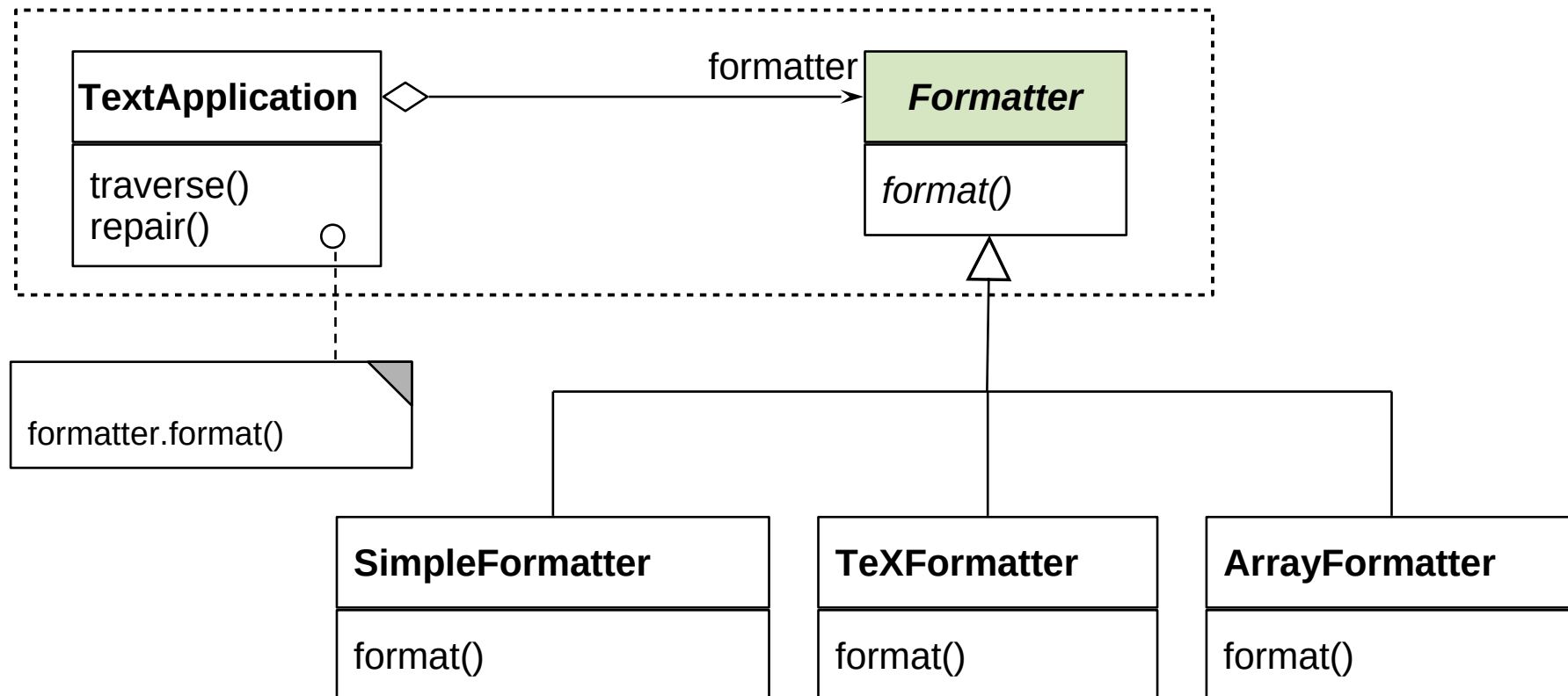

# Variability with Strategy

- ▶ Binding the hook class of a Strategy means to derive a concrete subclass from the **abstract hook superclass**, providing the implementation of the hook method

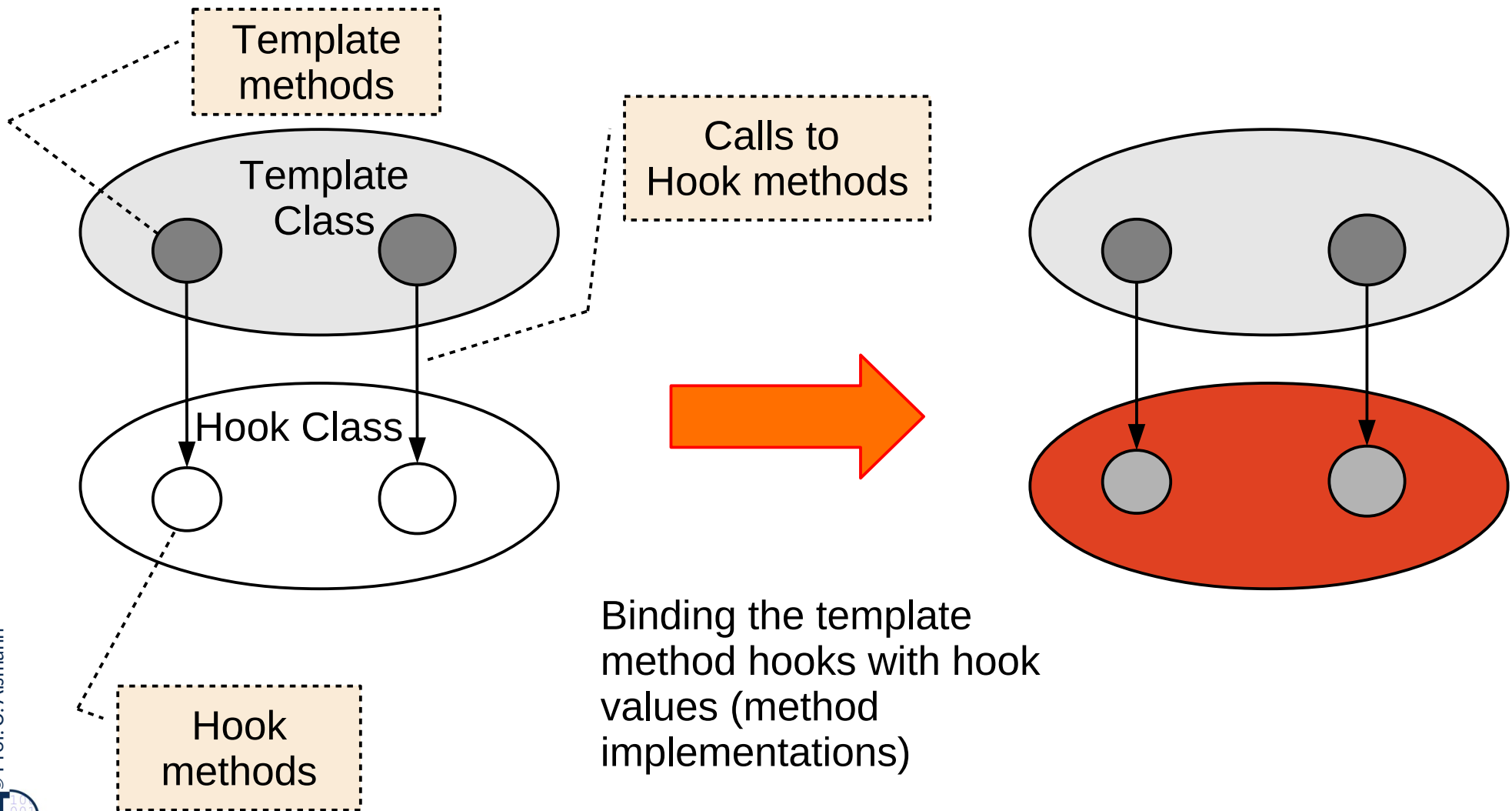



## 24.1.4. Factory Class



## 24.1.4 Factory Class (Abstract Factory)

- ▶ Allocate a family of products {Ai, Bi, ..} in different “flavors” or “colors” {1, 2, ..}
- ▶ Vary consistently by exchange of factory and object families

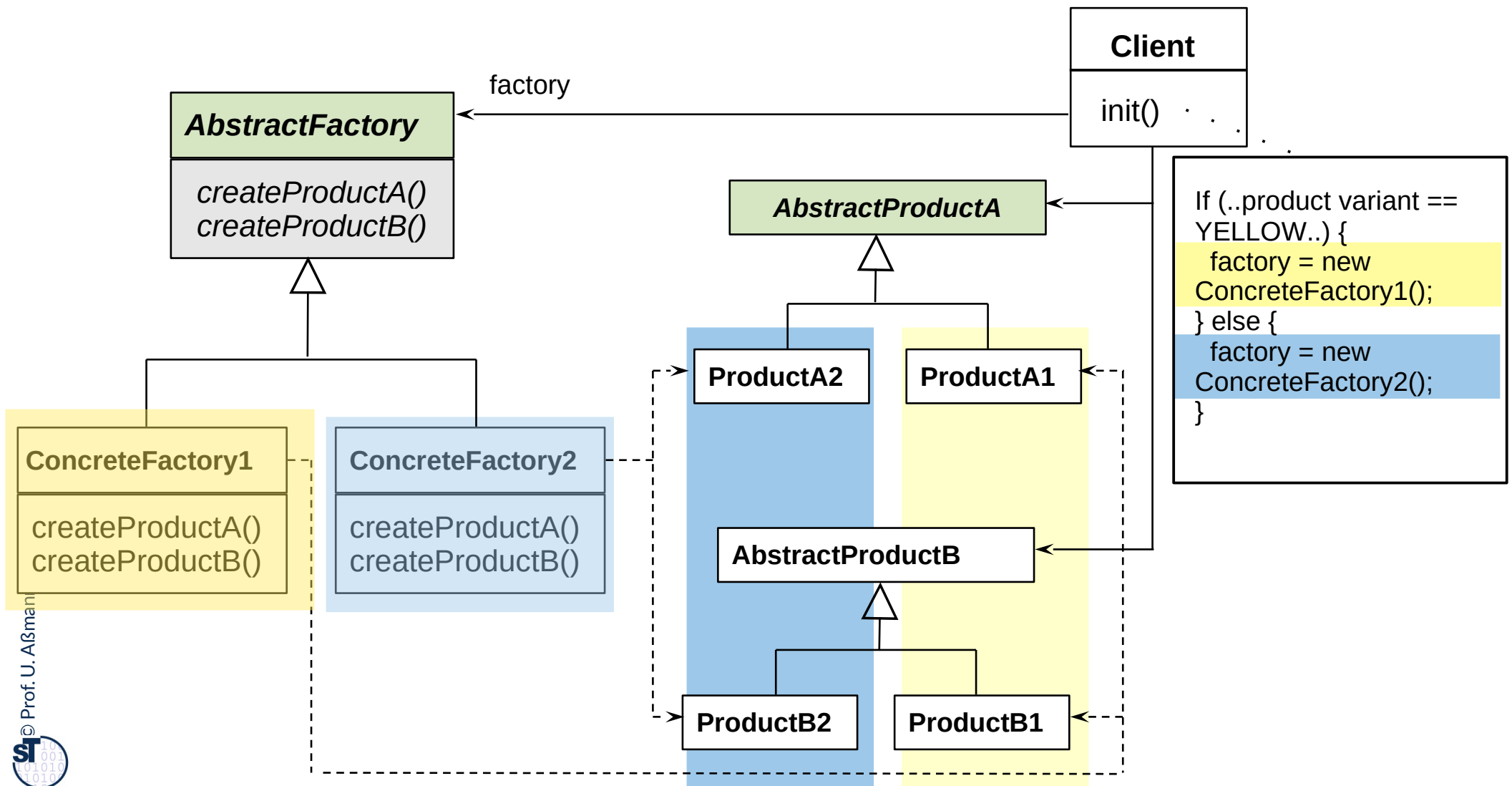

# Example for Factory Class

- ▶ Consistently varying a family of widgets

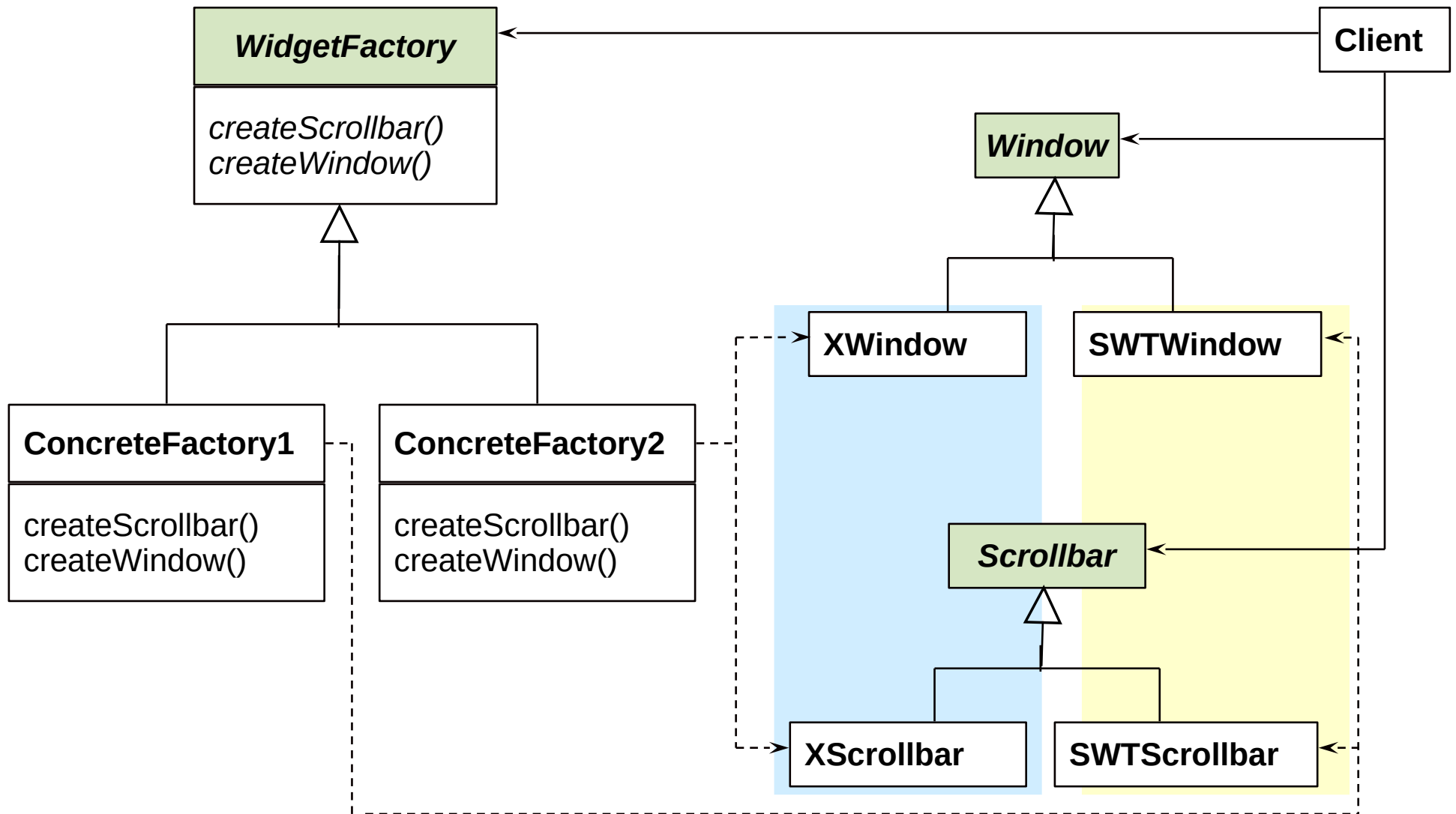

## 24.1.5 Bridge (Dimensional Class Hierarchies)



# Bridge for Complex Objects ( GOF-Version)

- ▶ A **Bridge** represents a *complex object* with two layers
- ▶ The left hierarchy (upper layer) is called *abstraction hierarchy*, the right hierarchy (lower layer) is called *implementation*

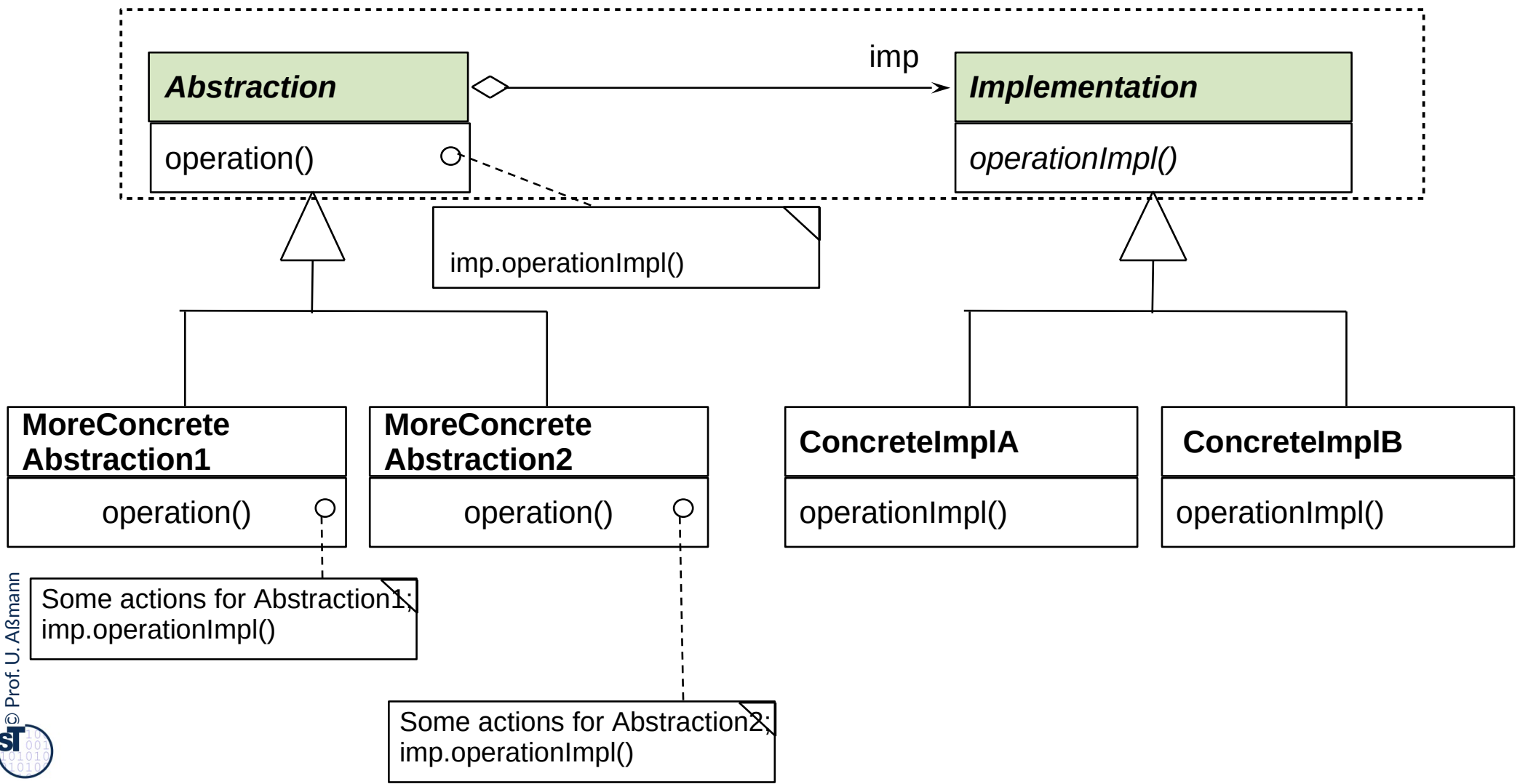

# Bridge as Dimensional Class Hierarchies

- ▶ Bridge is an extension of TemplateClass

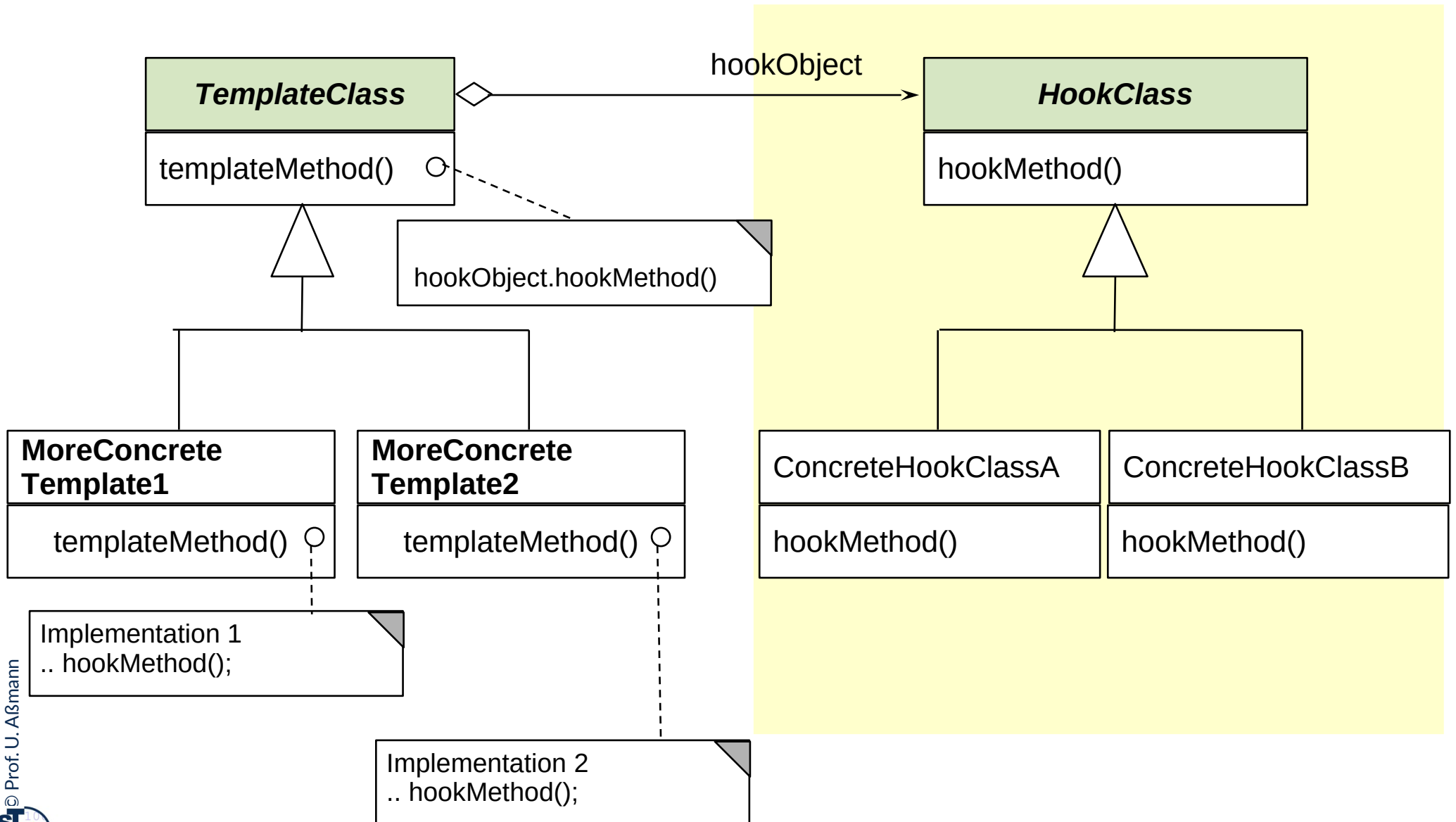

# Ex. Complex Object *DataGenerator* as Bridge

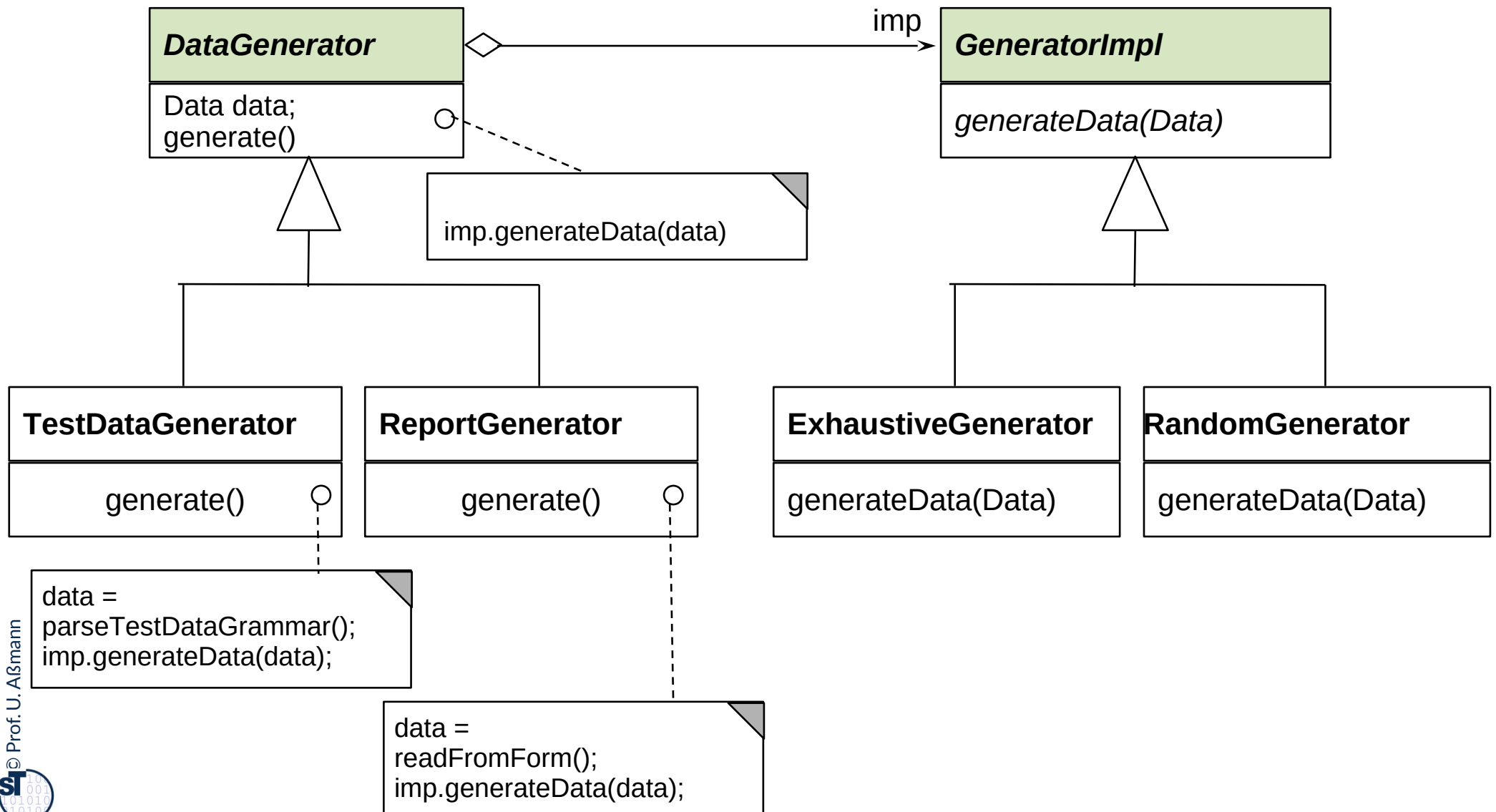

# Rpt.: Why Do We Need Variability?

- ▶ Functional features, packages (payed vs free use), etc
- ▶ Platforms (Hardware, operating system, database, GUI package, etc.)
- ▶ Dynamic contexts (personalization, time and location)

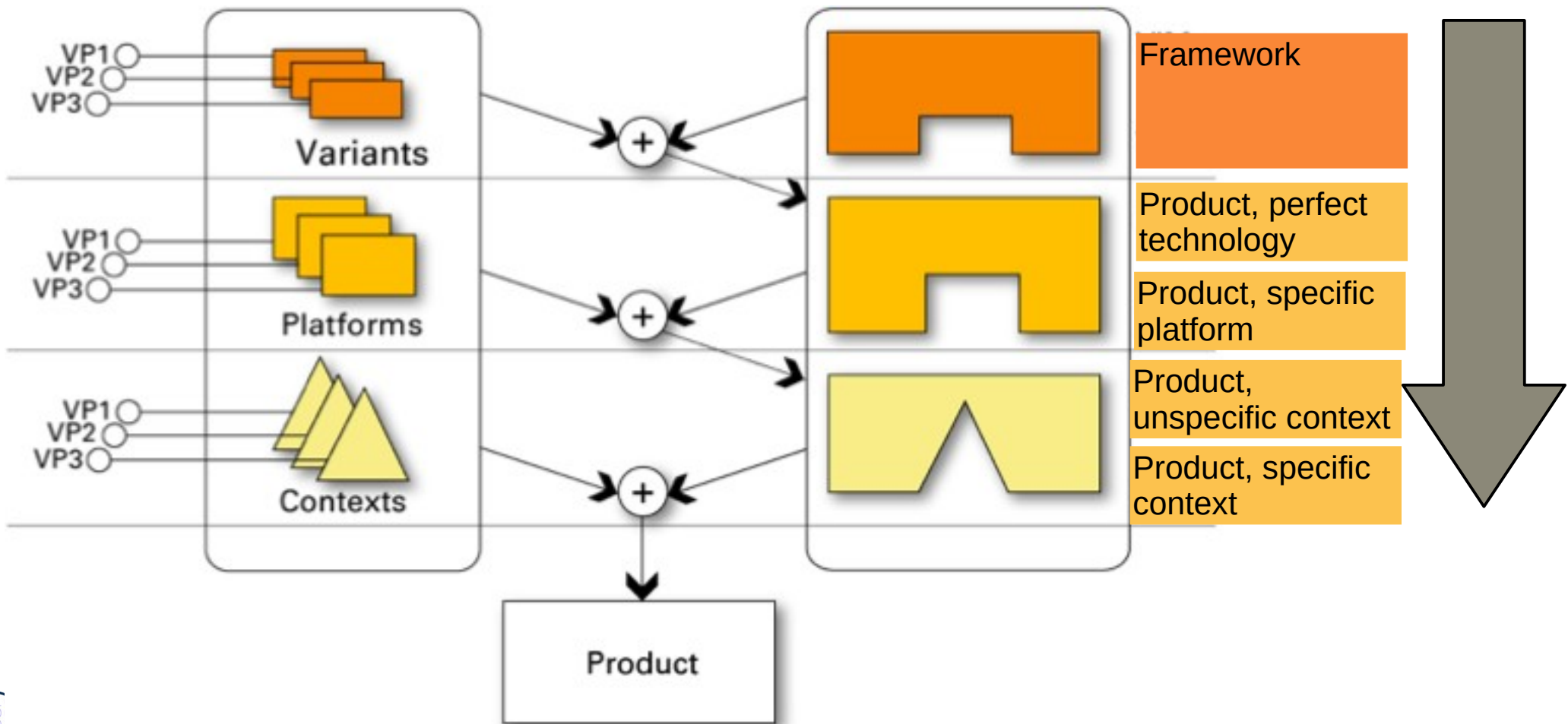



# Use of Bridge for Separation of Platform-Independent from Platform-Dependent Code

- ▶ Bridge can be used to implement an object with *platform-independent (left/upper hierarchy)* and *platform-specific part (lower/right hierarchy)*
- ▶ For every type of platform, there must be one Bridge

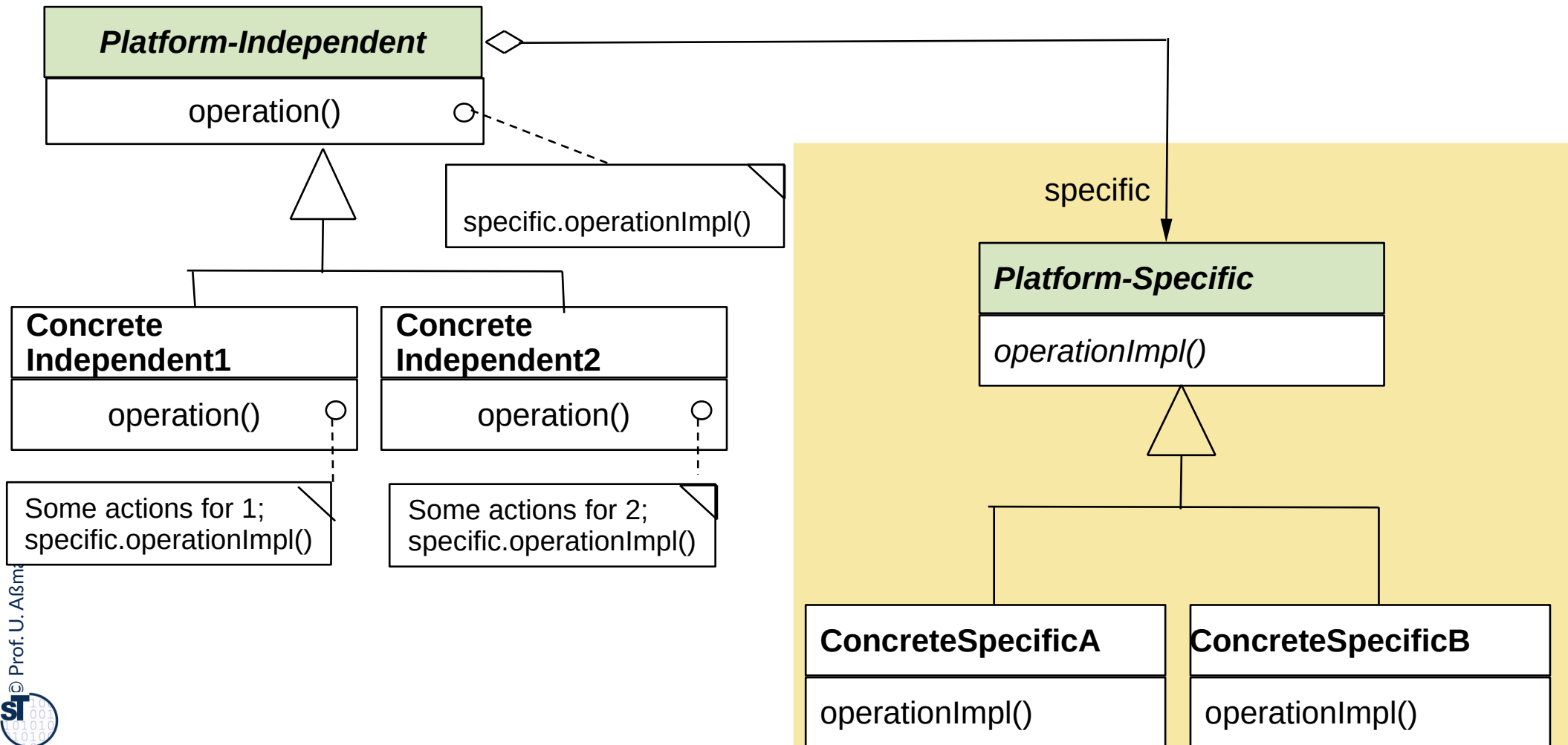

# Use of Bridge for Separation of Context-Independent from Context-Dependent Code

- ▶ Bridge can be used to implement an object with *context-independent* (left/upper hierarchy) and context-specific part (lower/right hierarchy)
- ▶ For every type of context, there must be one Bridge

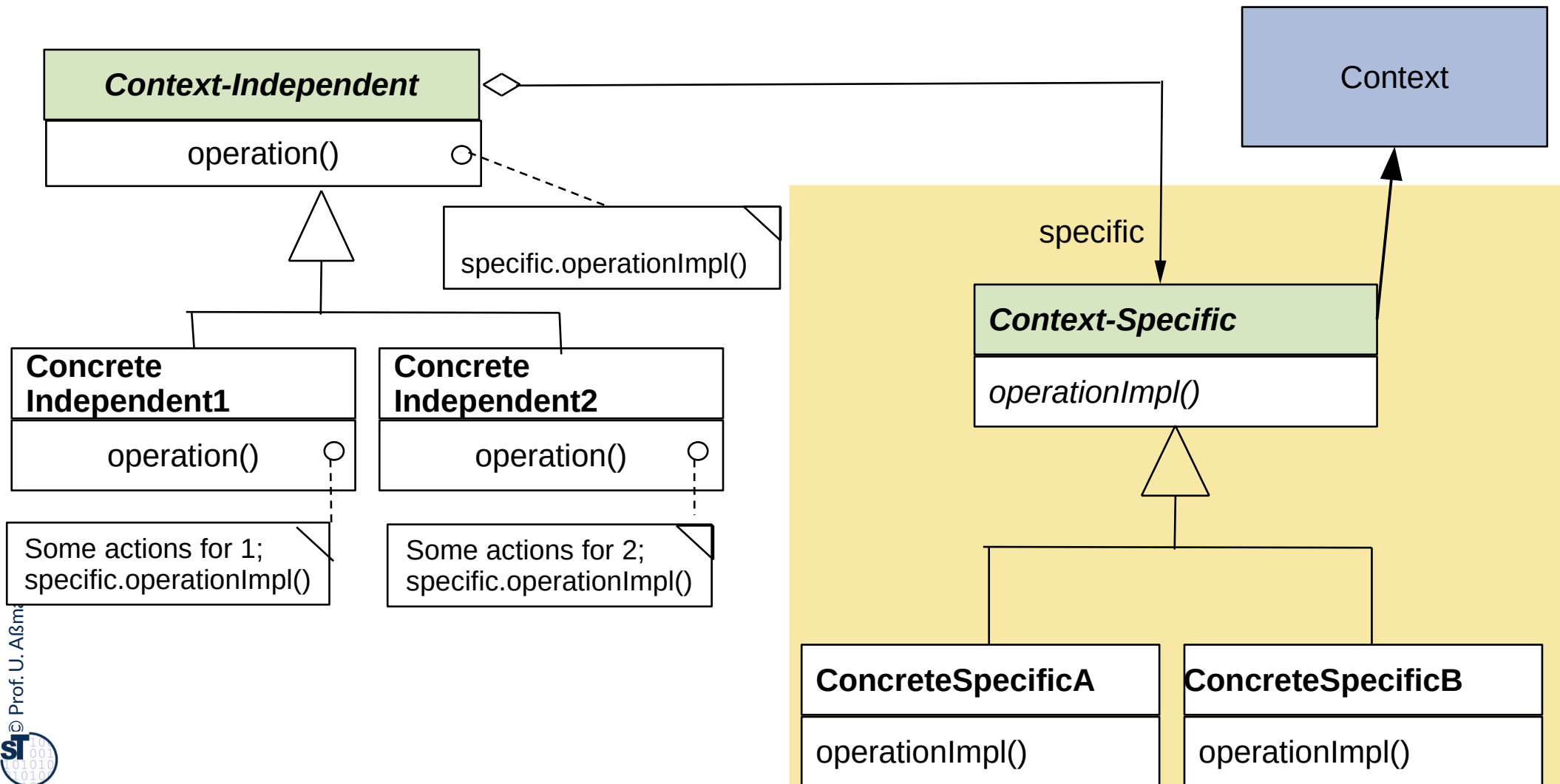

## 24.2) Patterns for Extensibility

Extensibility patterns describe how to build  
plug-ins (complements, extensions) to frameworks

Extensibility Pattern	# Run-time objects	Key feature
Composite	*	Whole/Part hierarchy
Decorator	*	List of skins
Callback	2	Dynamic call
Observer	1+*	Dynamic multi-call
Visitor	2	Extensible algorithms on a data structure
EventBus, Channel	*	Complex dynamic communication infrastructure (Appendix)

# 24.2.1 Structure Composite (Rpt.)

- ▶ Composite has an recursive n-aggregation to the superclass

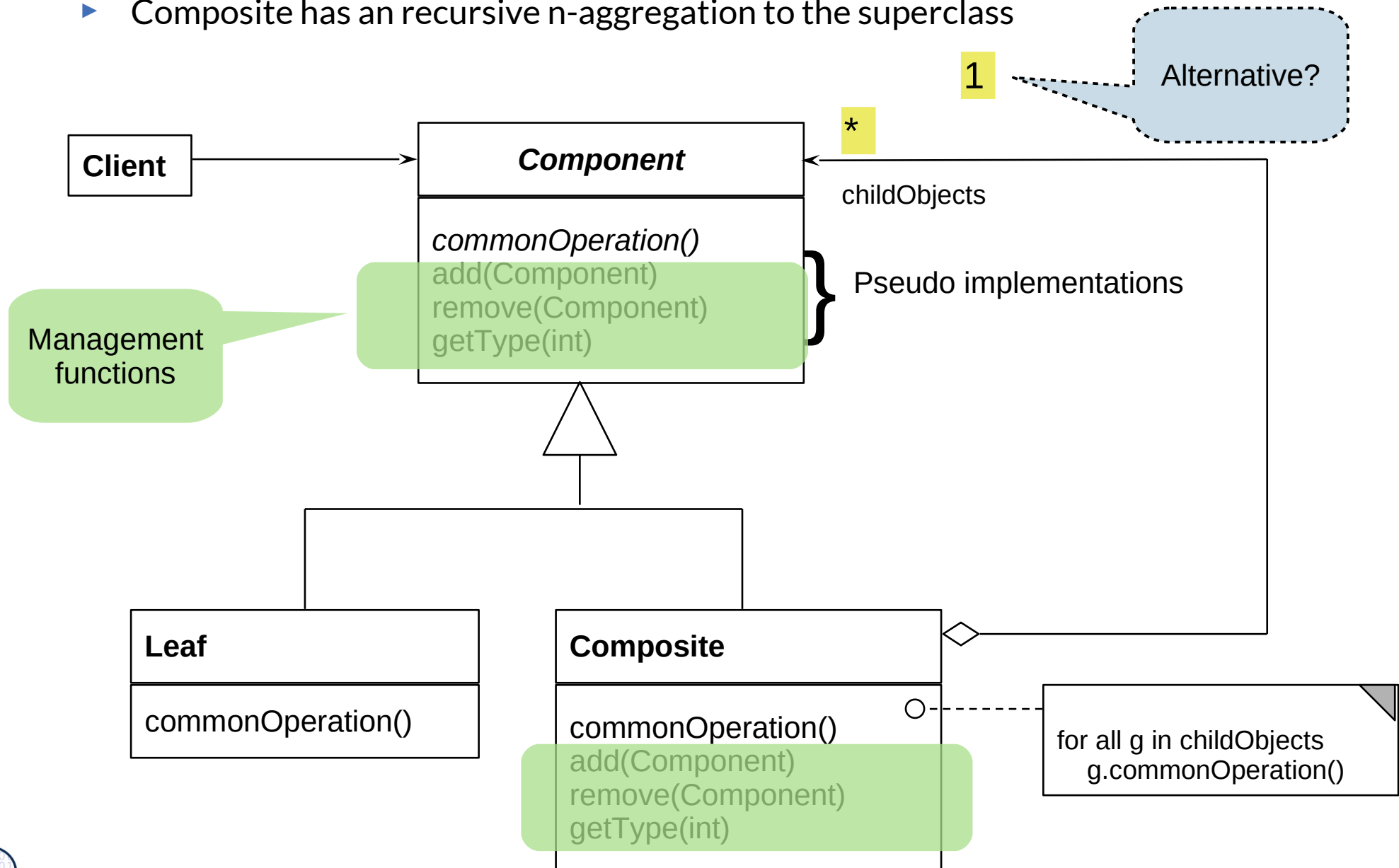

## 24.2.2. Decorator

- ▶ The “sibling” of Composite



# Problem

- ▶ How to extend an inheritance hierarchy of a library that was bought in binary form?
- ▶ How to avoid that an inheritance hierarchy becomes too deep?

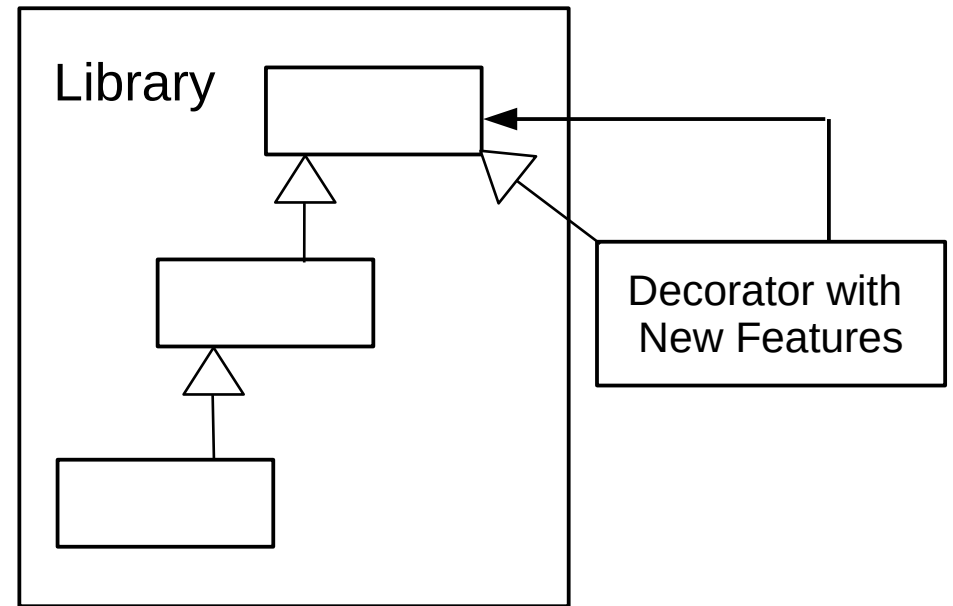
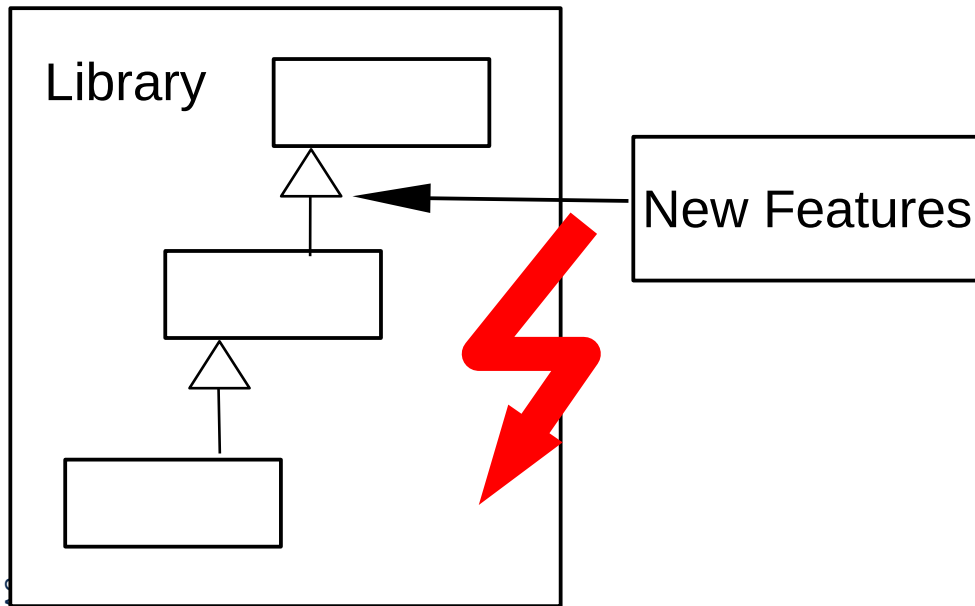

# Snapshot of Decorator Pattern

- ▶ A Decorator object is a *skin* of another object
- ▶ The Decorator class *mimics* a class

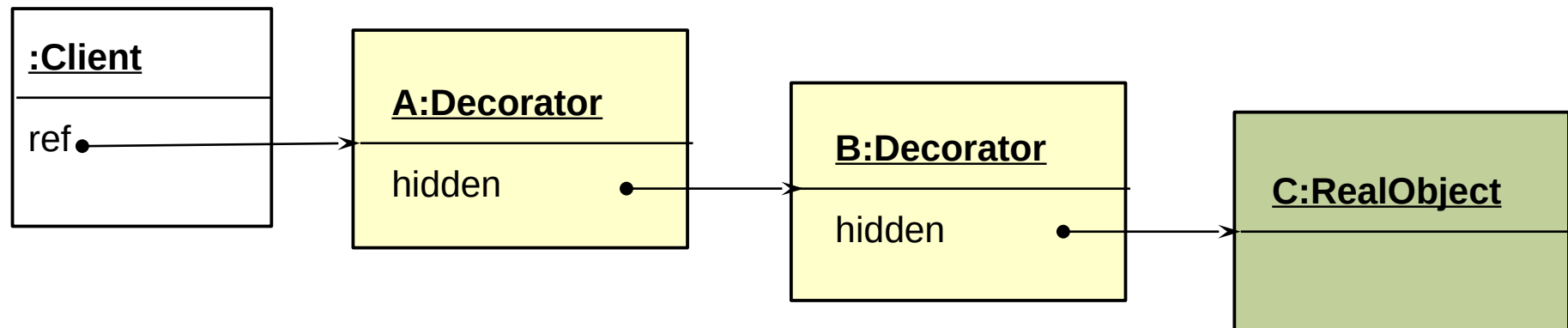

# Decorator – Structure Diagram

- ▶ It is a restricted Composite with a 1-aggregation to the superclass
  - A subclass of a class that contains an object of the class as child
  - However, only one composite (i.e., a delegatee)
  - Combines inheritance with aggregation

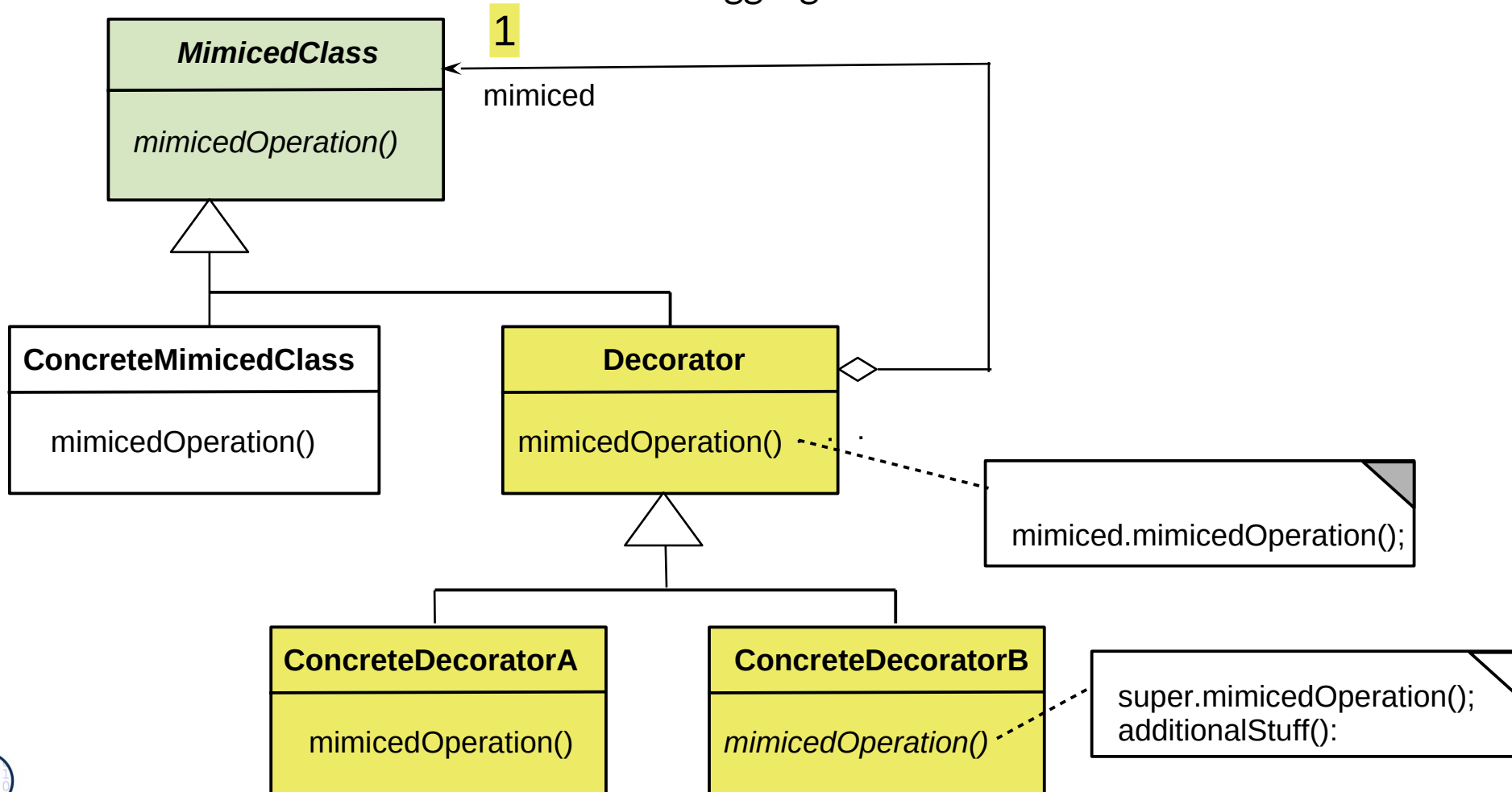



# Ex.: Decorator for Widgets

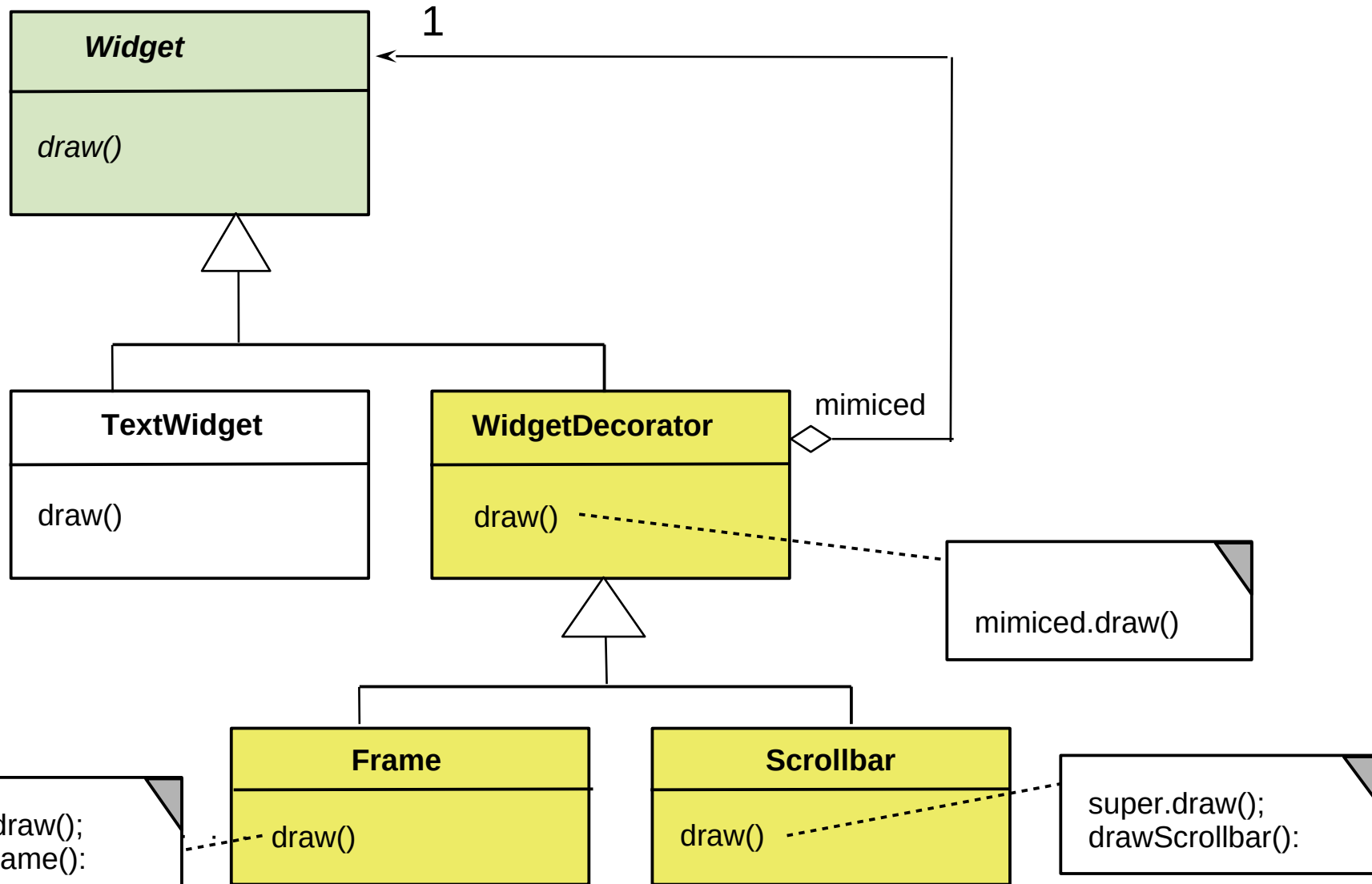

# Purpose Decorator

- ▶ For dynamically extensible objects (i.e., decoratable objects)
  - Addition to the decorator chain or removal possible
- For complex objects

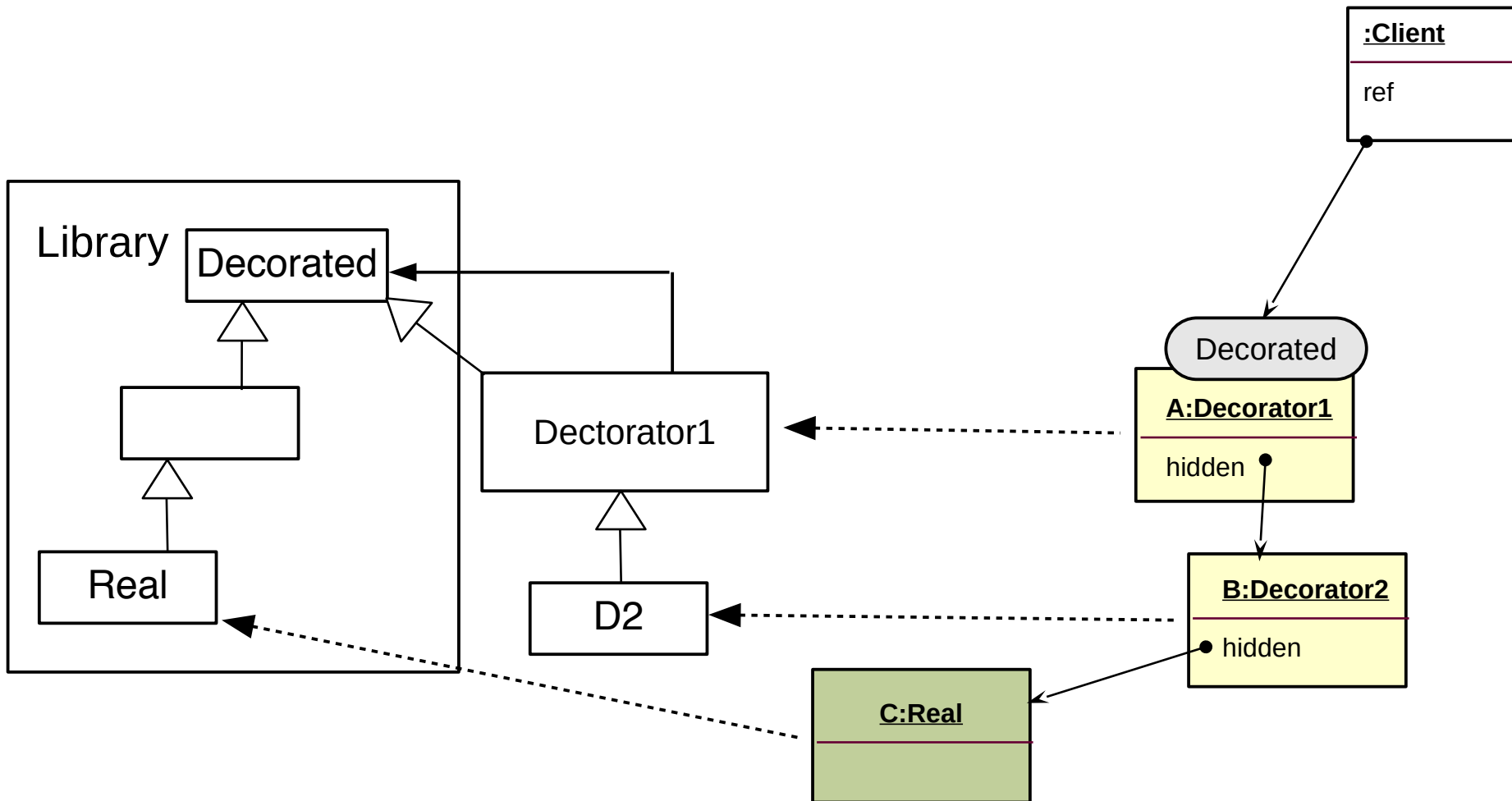

## 24.2.3 Different Kinds of Publish/Subscribe Patterns – (Event Bridge)

- ▶ Publish/Subscribe patterns are for dynamic, event-based communication in synchronous or asynchronous scenarios
- ▶ Subscribe functions build up dynamic communication nets
- ▶ Callback
- ▶ Observer
- ▶ EventBus



# Publish/Subscribe Patterns

- ▶ Distinguish: Subscription of Observers to Subjects // Notification of event // Source of event (subject) // Data to be transferred // Relation of Subject and Observer
- ▶ Therefore, Observer exists in several variants (push, pull, CallBack, EventBus, ChannelBus)

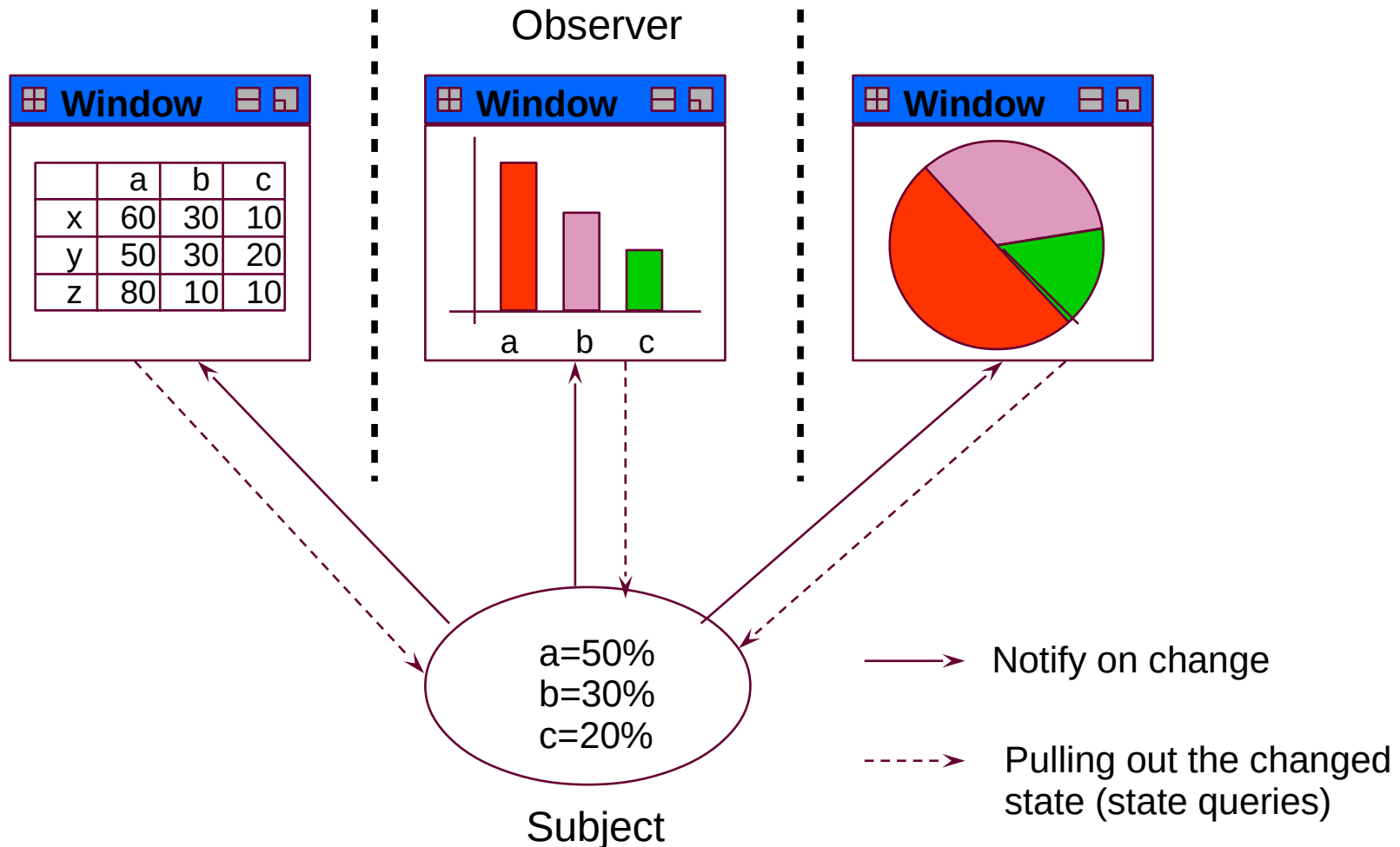

# Overview

Push		Data is flowing with the call to “update”
	Callback	1 observer
	Observer	n observer
Pull		Data is pulled on demand
	Callback	1 observer
	Observer	n observer

- ▶ A **callback** is a variant of the observer pattern with **one** observer

# 24.2.3.1 Publish/Subscribe with 1 Observer: Callback

- ▶ **Callbacks** have only one observer. It is not known statically, but registered dynamically, at run time
- ▶ A (push-)Callback pushes its data with the call to run

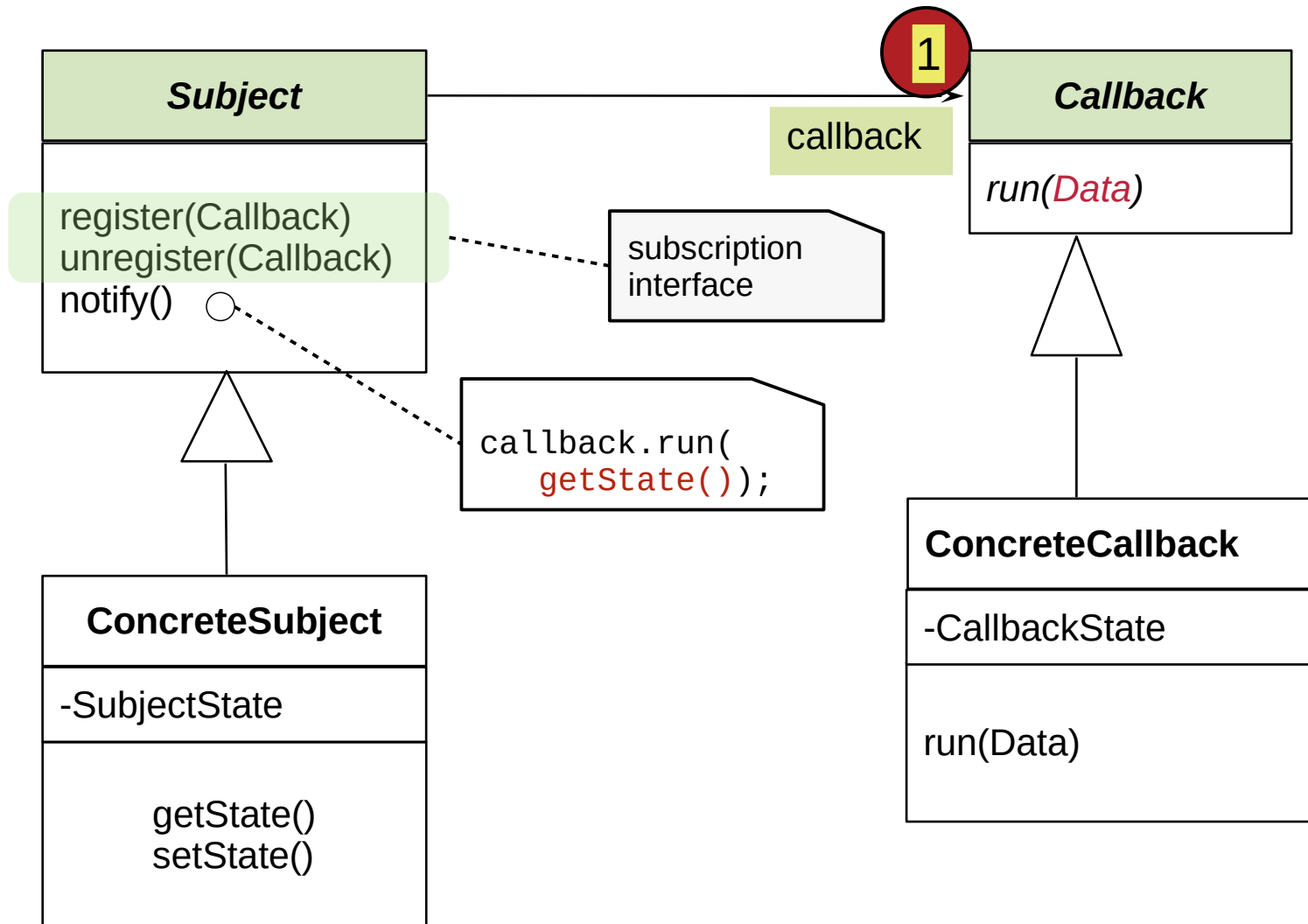

# Sequence Diagram push-Callback

- ▶ `run()` directly transfers Data to Observer (push)

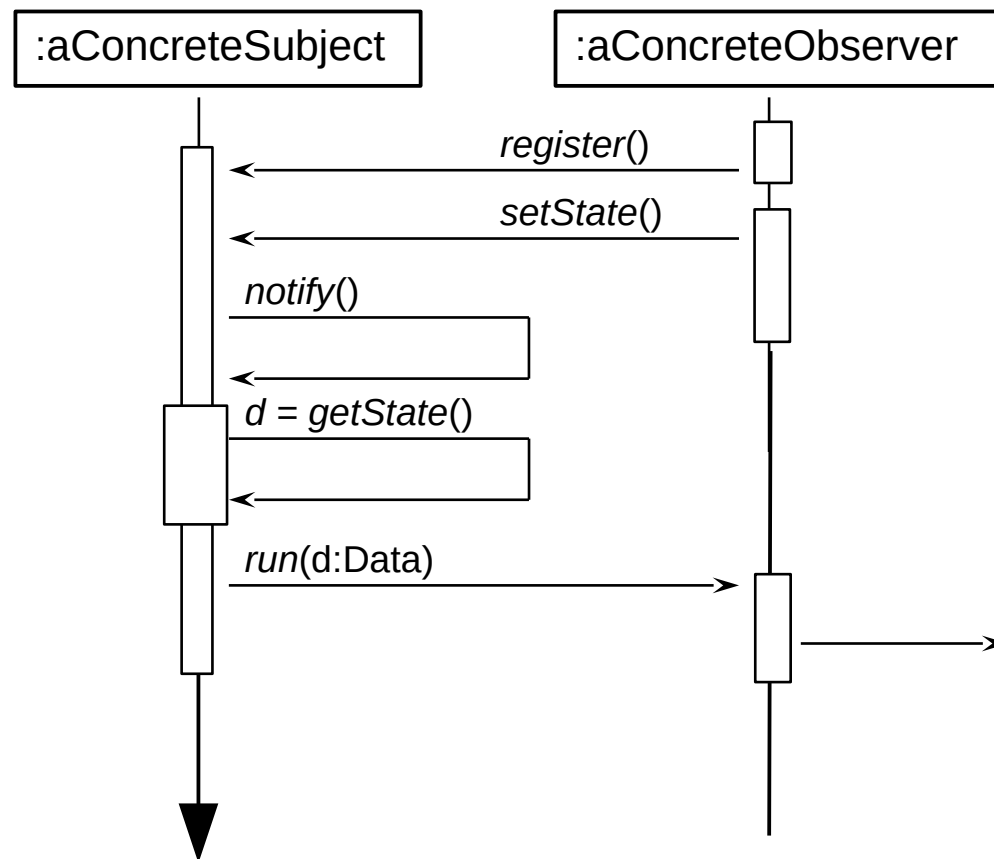

## 24.2.3.2 Structure pull-Callback (Delayed Data Transfer)

- ▶ A **pull-Callback** pushes the Subject to the Callback to later pull the data
- ▶ Responsibility for pull lies with the Callback; Subject is passed as argument

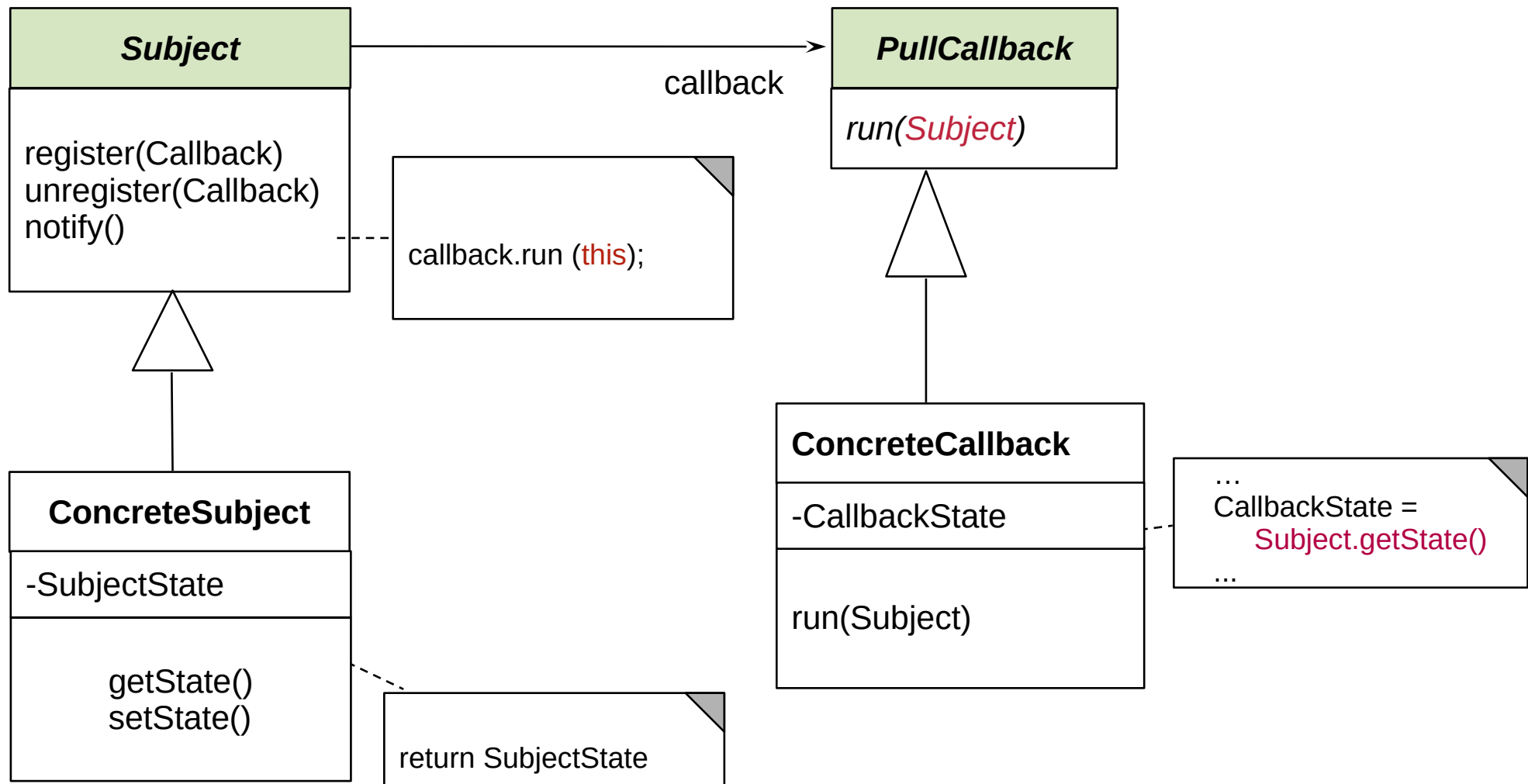



# Sequence Diagram pull-Callback

41

Softwaretechnologie (ST)

- ▶ Update() does not transfer data, only an event (anonymous communication possible)
  - Observer pulls data out itself with getState()
  - Lazy processing (on-demand processing)

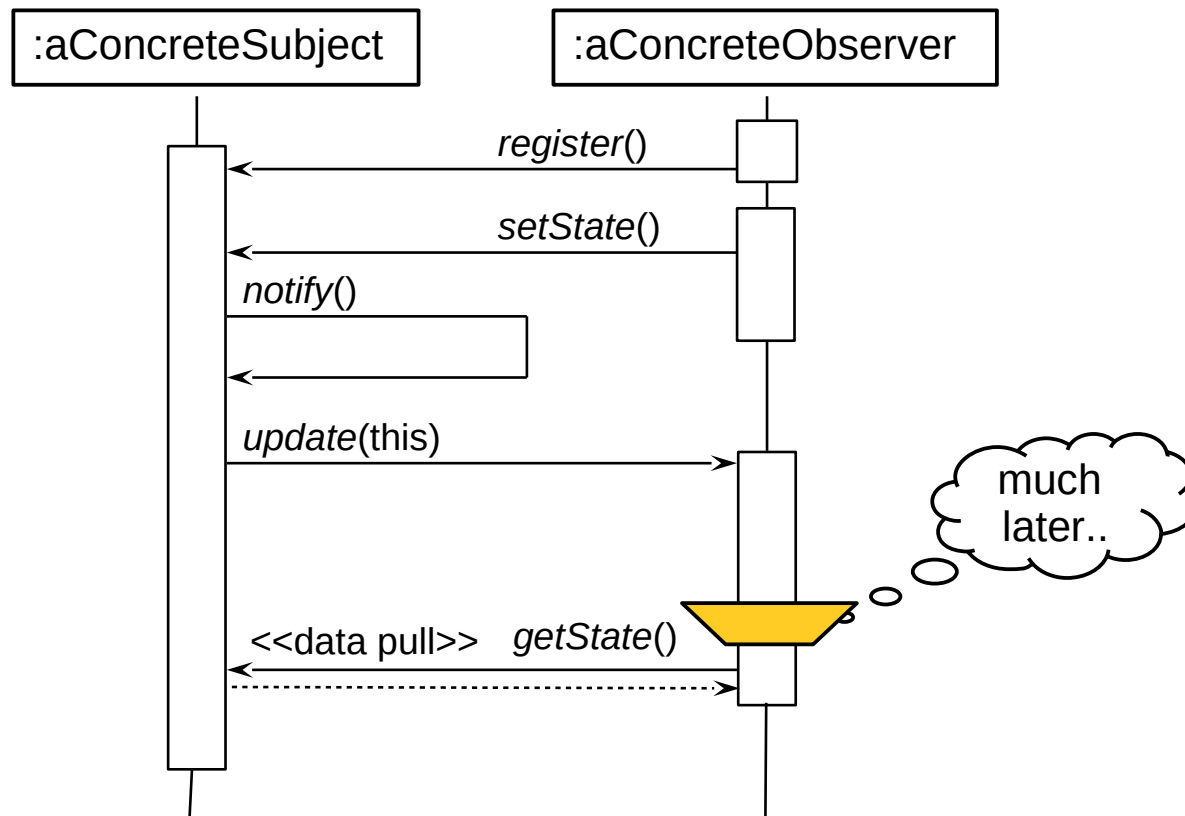

# 24.2.3.3 Structure push-Observer (Immediate Data Transfer)

- ▶ Subject pushes data with update (Data)
- ▶ Pushing resembles Sink, if data is pushed iteratively

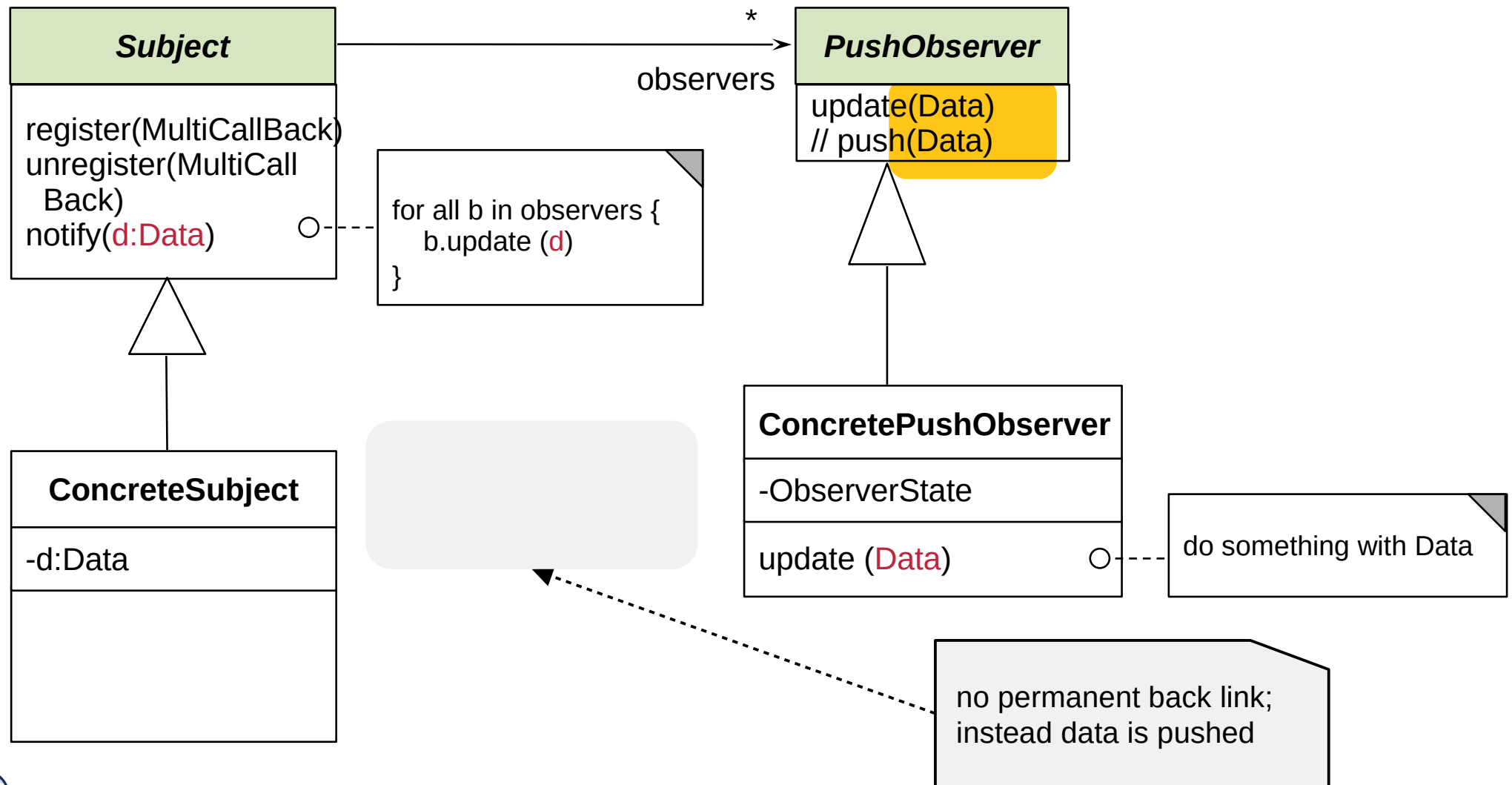

# Sequence Diagram push-Observer

- ▶ Update() transfers Data to Observer (push)

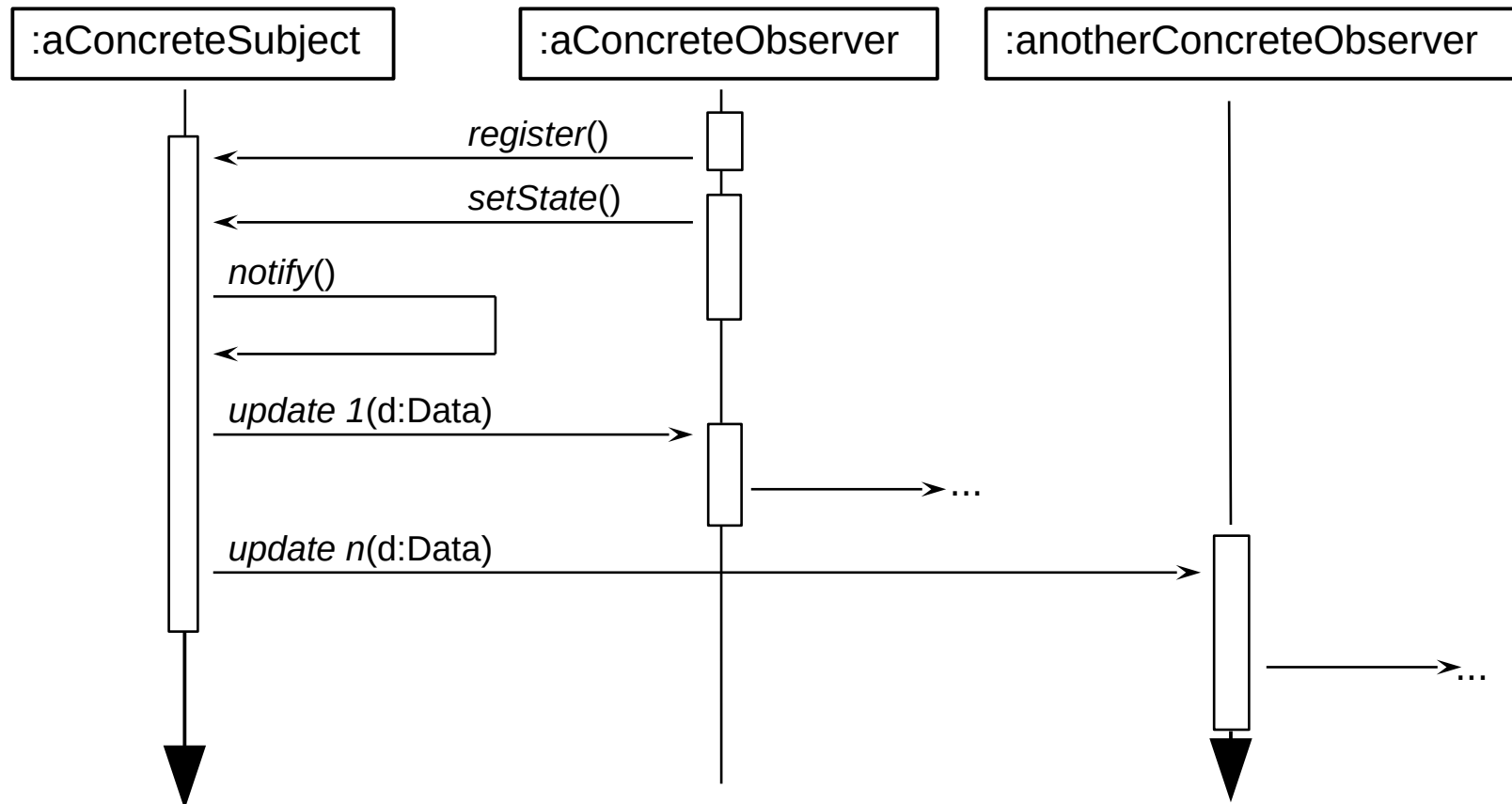

# 24.2.3.4 Pull-Observer (Delayed Data Transfer, The Gamma Variant, Rpt.)

- ▶ The pull-Observer does not push anything, but pulls data later out with `getState()` or `getNext()` (same as in Iterator)
- ▶ Pulling resembles *Iterator (Stream)*, if data is pulled repeatedly

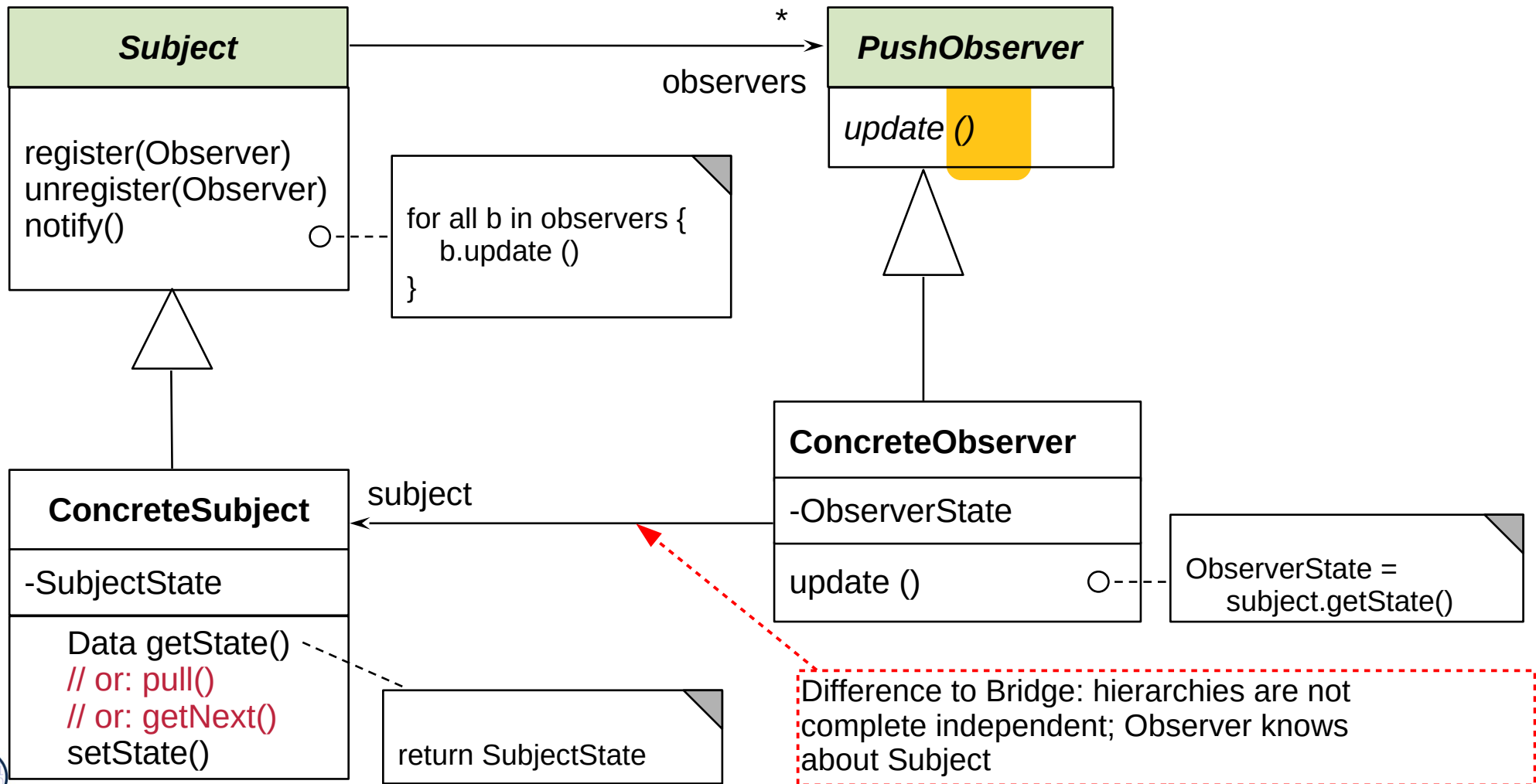

# Sequence Diagram pull-Observer

45

Softwaretechnologie (ST)

- ▶ Update() does not transfer data, only an event (anonymous communication possible)
  - Observer pulls data out itself with getState()
  - Lazy processing (on-demand processing) with large data
- ▶ pull-Observer uses Iterator, if data is pulled iteratively

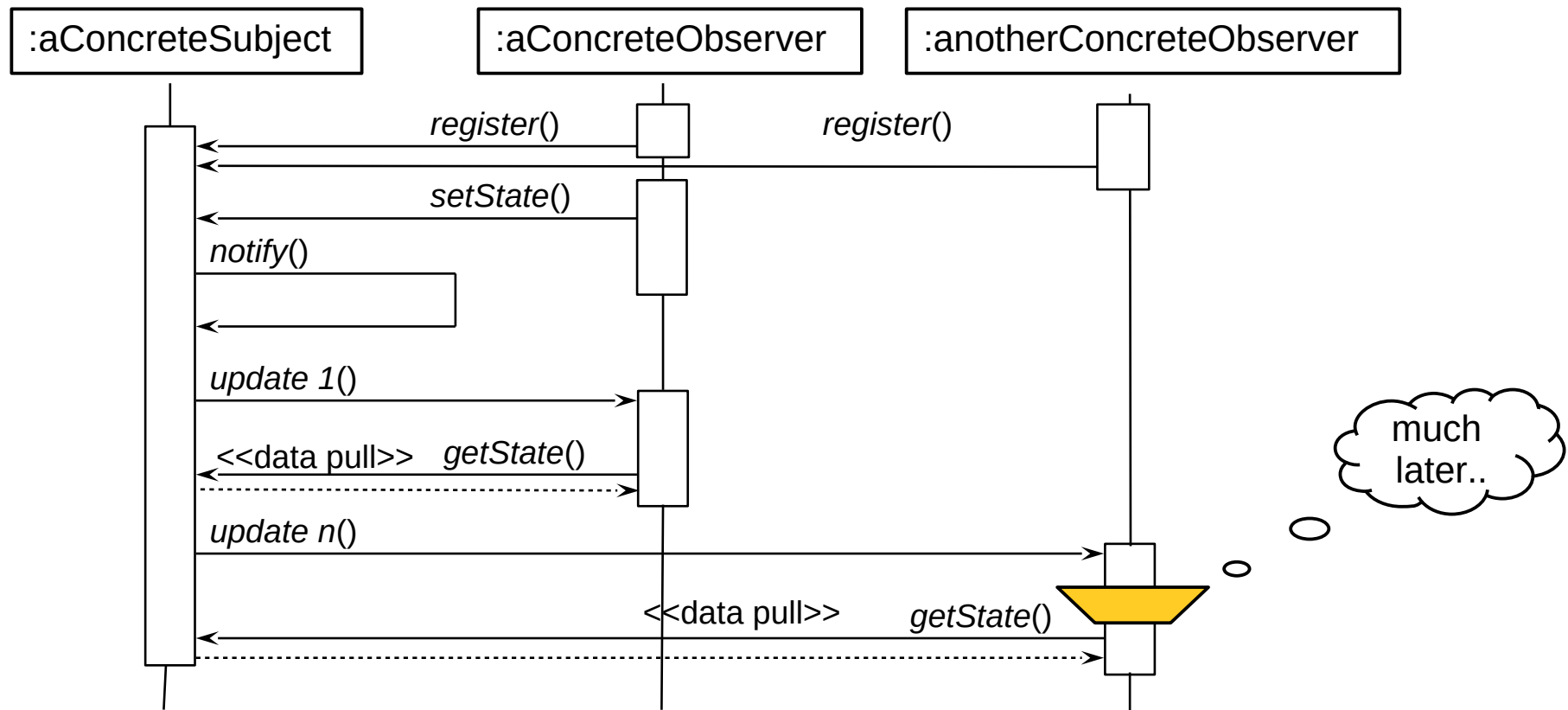

## 24.2.4. Visitor

Visitor provides an extensible family of algorithms on a data structure  
Powerful pattern for modeling Materials and their Commands



# Visitor (VisitingAlgorithm)

- ▶ Implementation of *complex object* with a 2-dimensional structure
  - First dispatch on dimension 1 (data structure), then on dimension 2 (algorithm)
  - The Visitor has a lot of Callback methods (Command methods)
- ▶ Beauty: visiting algorithms can be added without touching the DataStructure

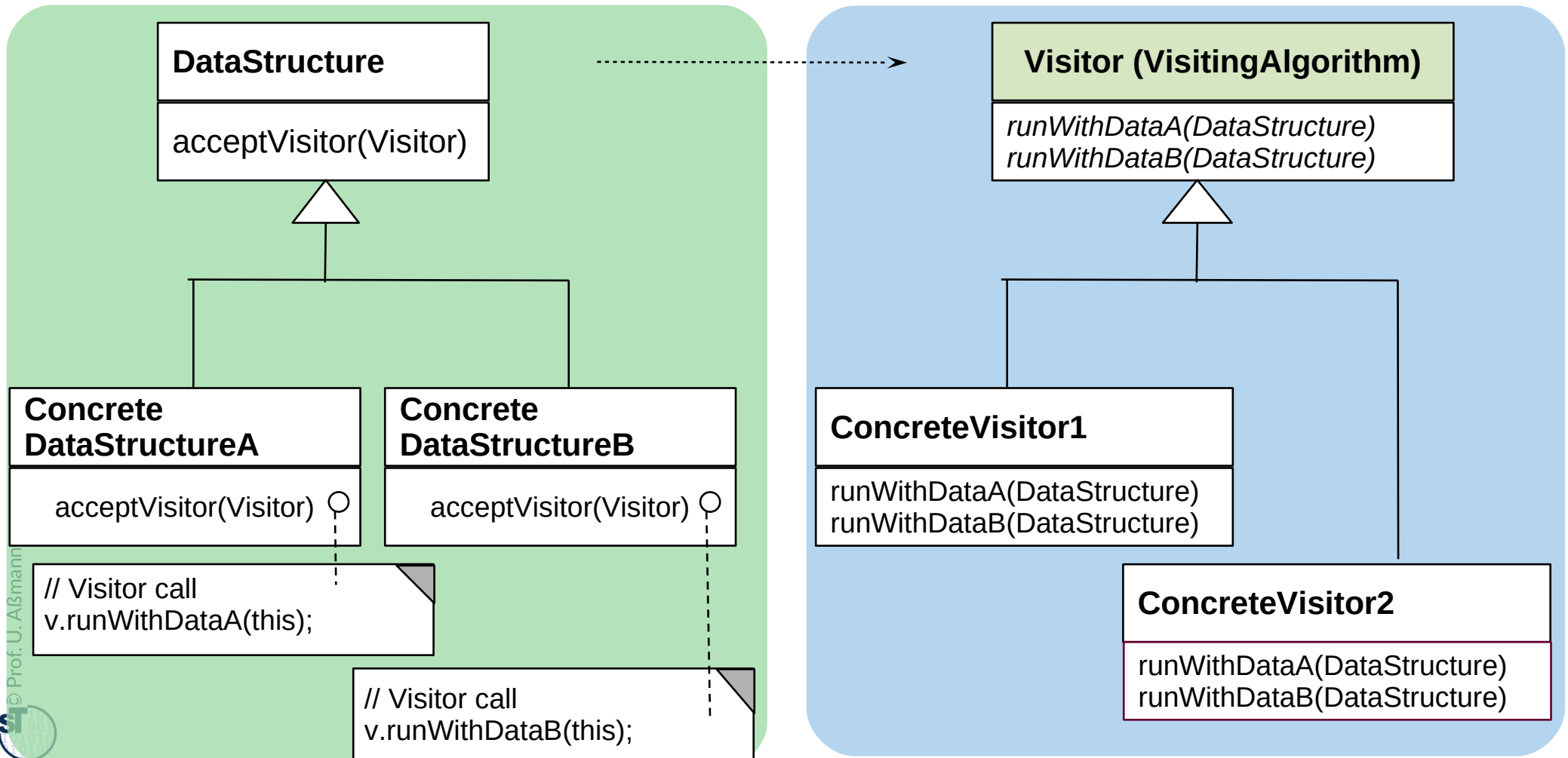

# Sequence Diagram Visitor

- ▶ First dispatch on data, then on visiting algorithm

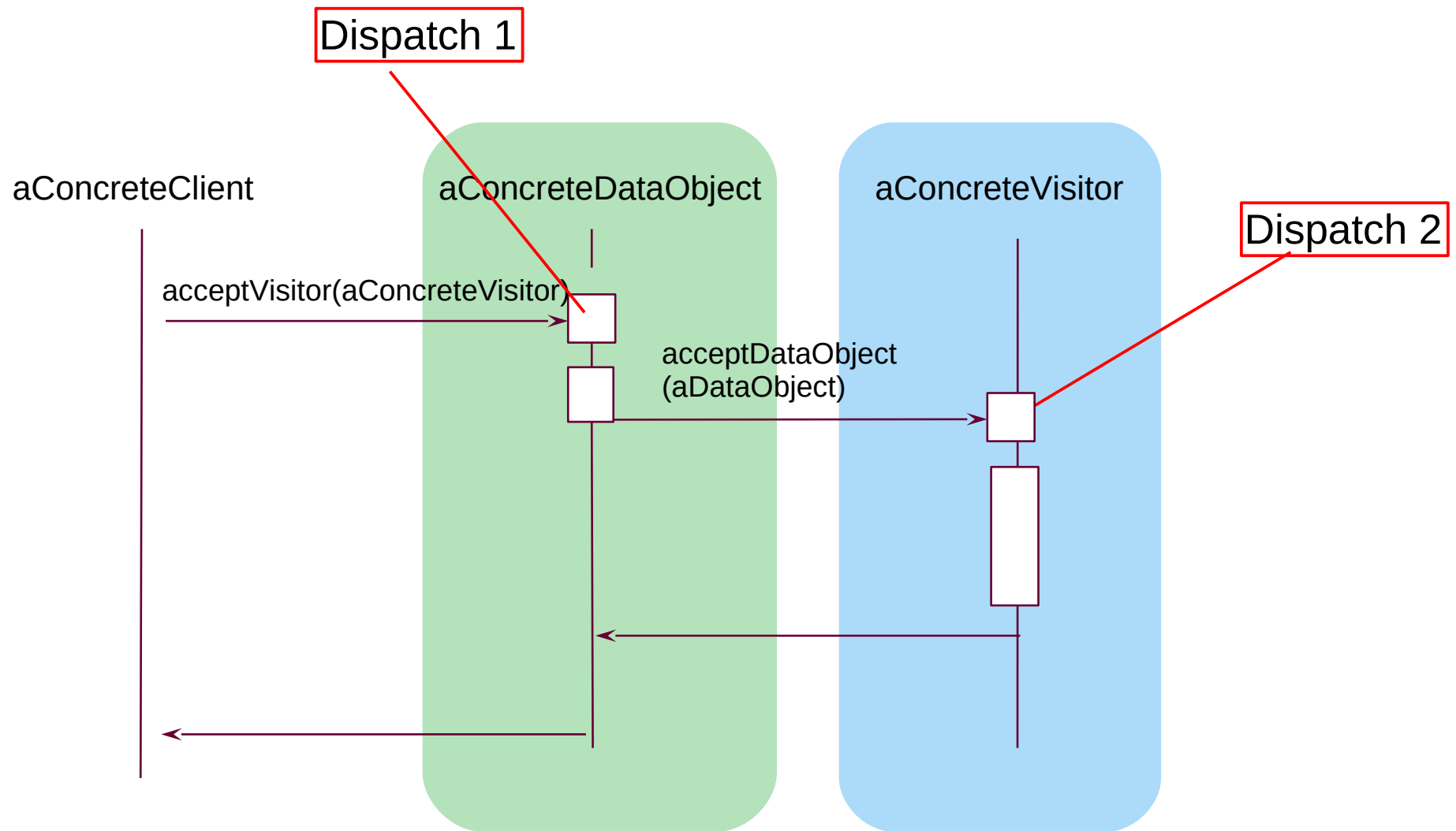



# Intermediate Data of a Compiler: Working on Syntax Trees of Programs with Visitors

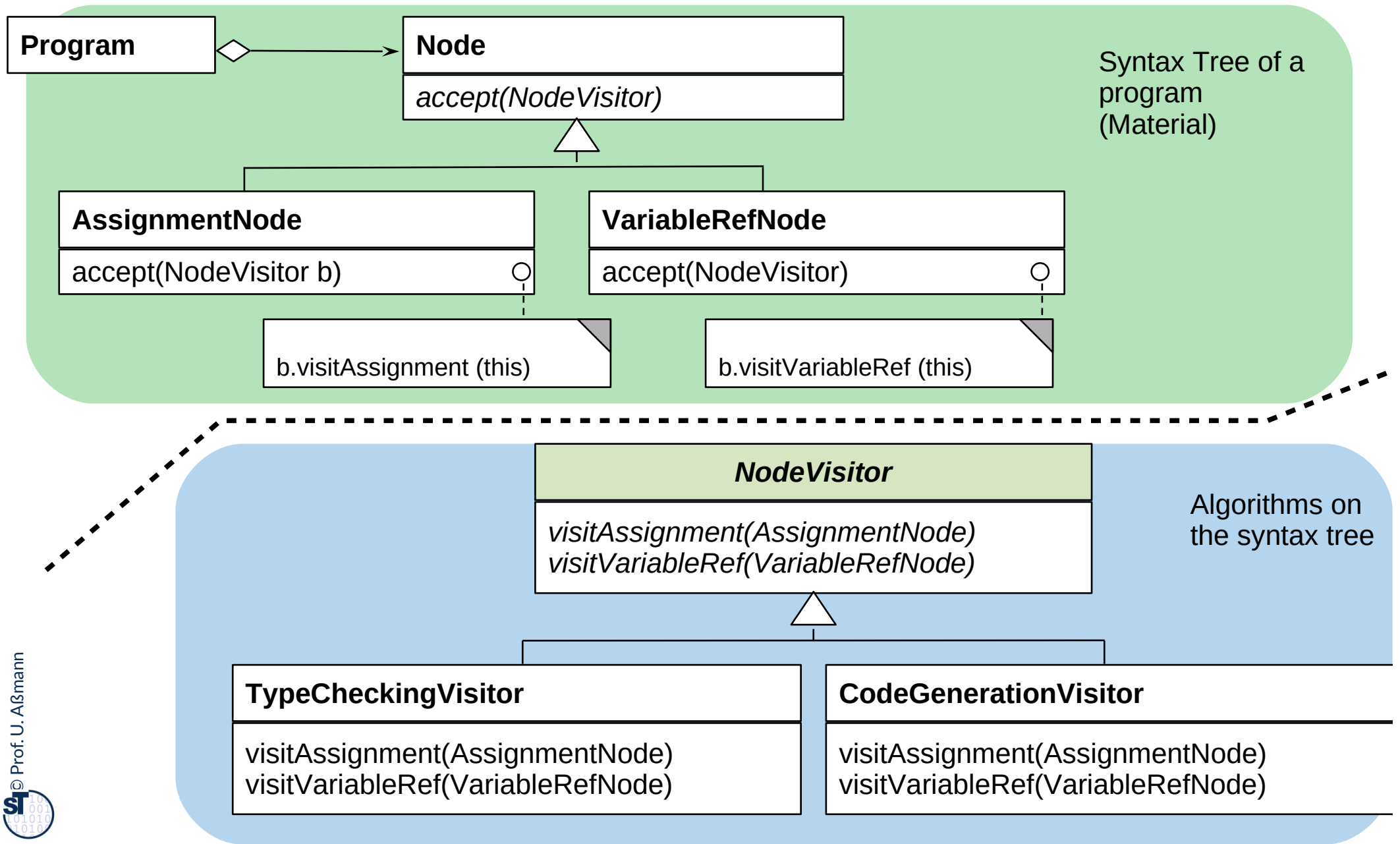

## 24.3) Patterns for Glue - Bridging Architectural Mismatch

Glue Pattern	# Run-time objects	Key feature
Singleton	1	Only one object per class
Adapter	2	Adapting interfaces and protocols that do not fit
Facade	1+*	Hiding a subsystem
Class Adapter	1	Integrating the adapter into the adaptee
Proxy (Appendix)	2	1-decorator

## 24.3.1 Singleton (dt.: Einzelinstanz)

- ▶ Problem: Store the global state of an application
  - Ensure that only *one* object exists of a class

Singleton
– <u>theInstance: Singleton</u>
<u>getInstance(): Singleton</u>

The usual constructor is invisible

```
class Singleton {  
    private static Singleton theInstance;  
    private Singleton () {}  
    public static Singleton getInstance() {  
        if (theInstance == null)  
            theInstance = new Singleton();  
        return theInstance;  
    }  
}
```

## 24.3.2 Adapter



# Object Adapter

- ▶ An **object adapter** is a kind of a proxy mapping one interface, protocol, or data format to another

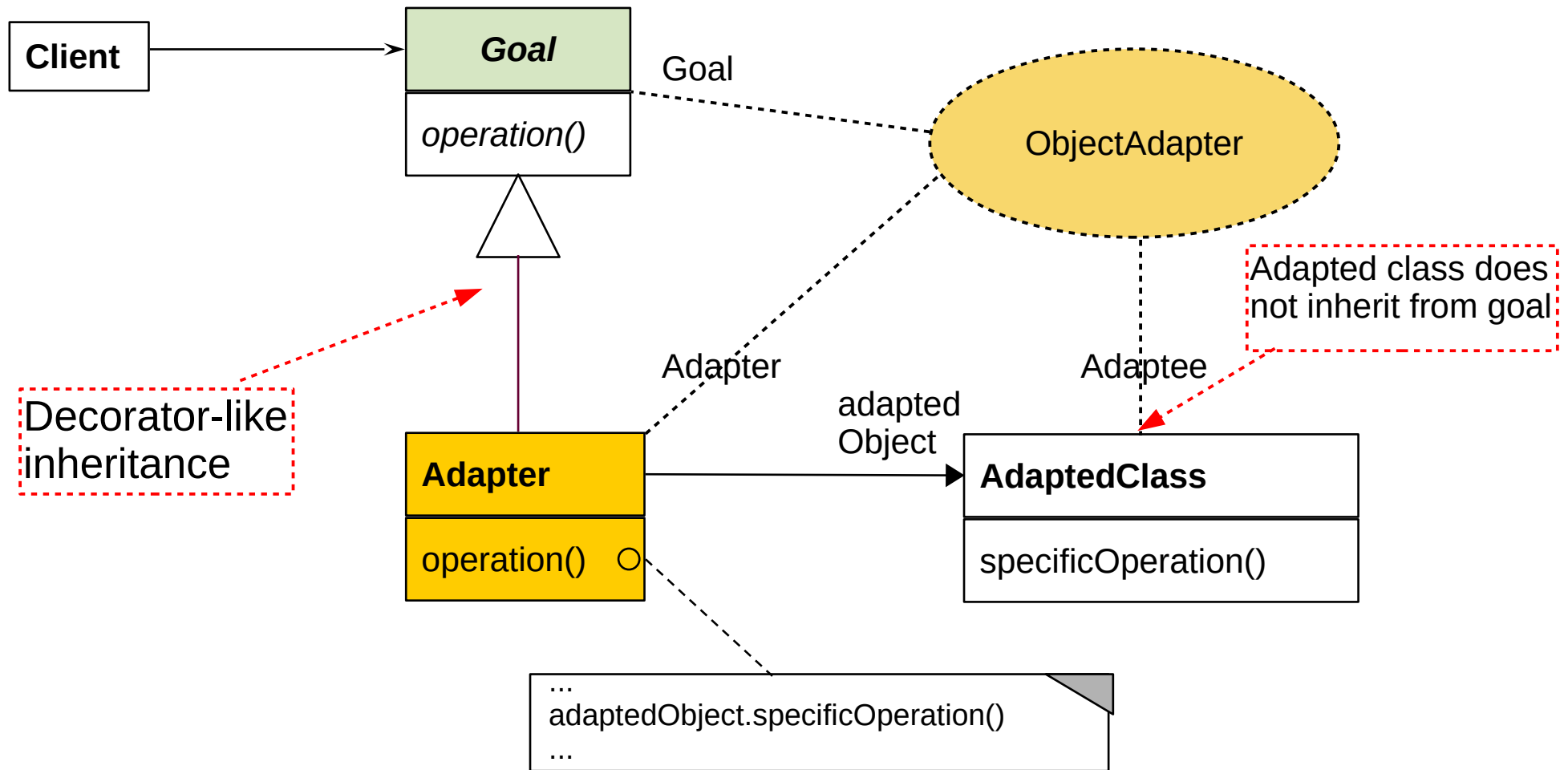

# Example: Use of an External Class Library For Texts

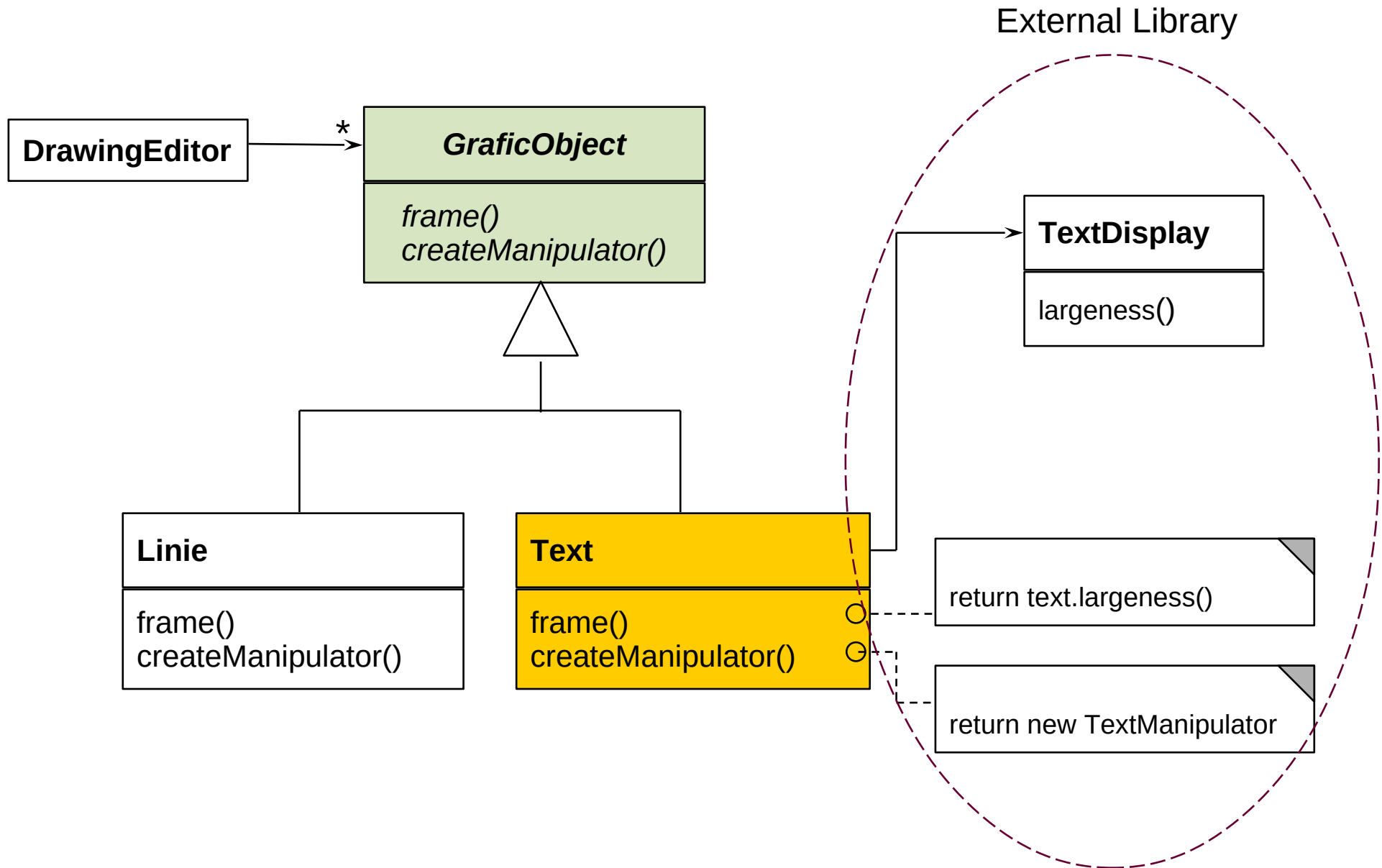

# 24.3.3 Facade Hides a Subsystem

- ▶ A **facade** is a specific object adapter hiding a complete set of objects (subsystem)
  - The facade has to map its own interface to the interfaces of the hidden objects

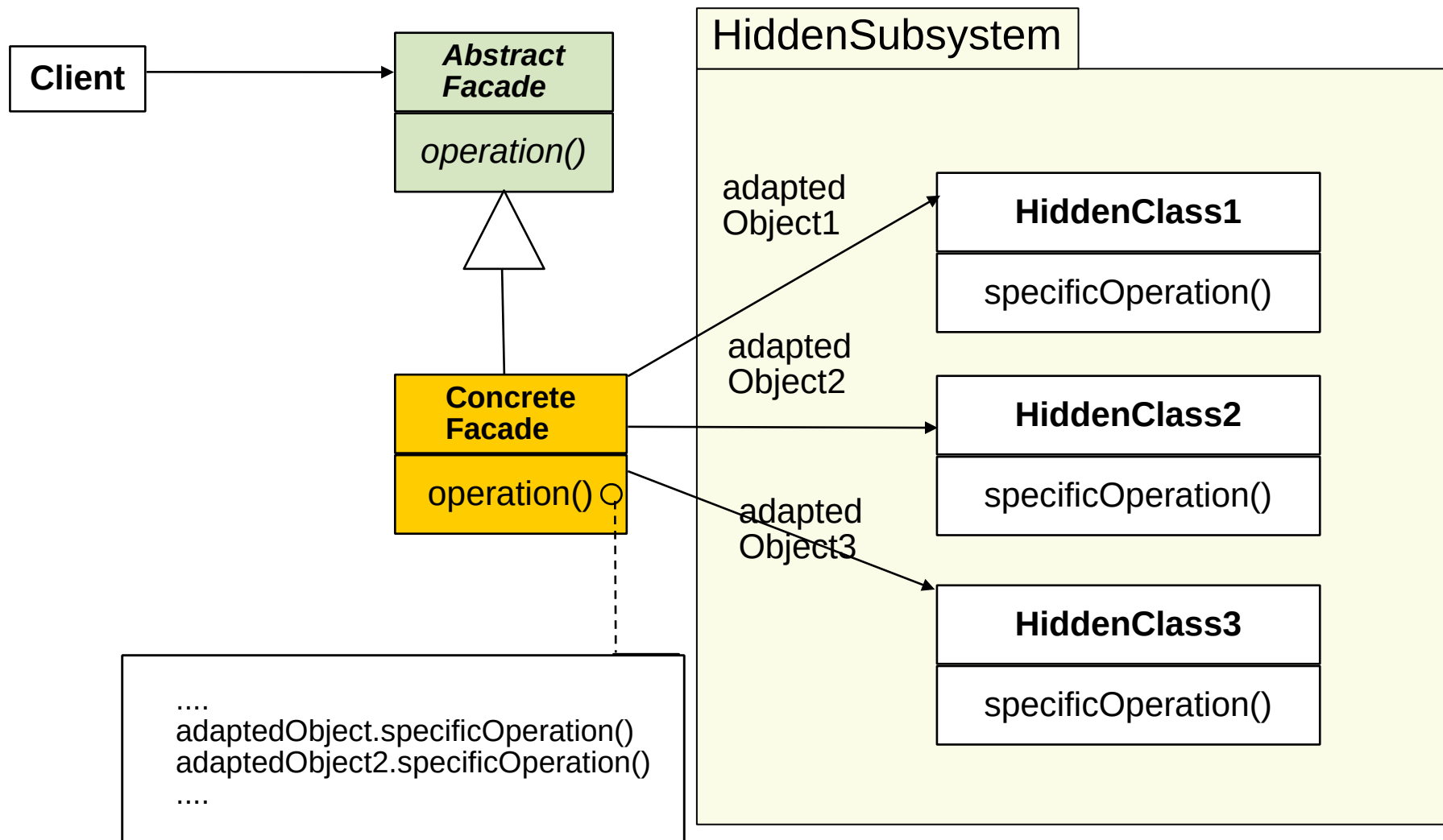

# Refactoring a Legacy System Towards a Facade

- ▶ After a while, components are too much intermingled
- ▶ Facades serve for clear layered structure

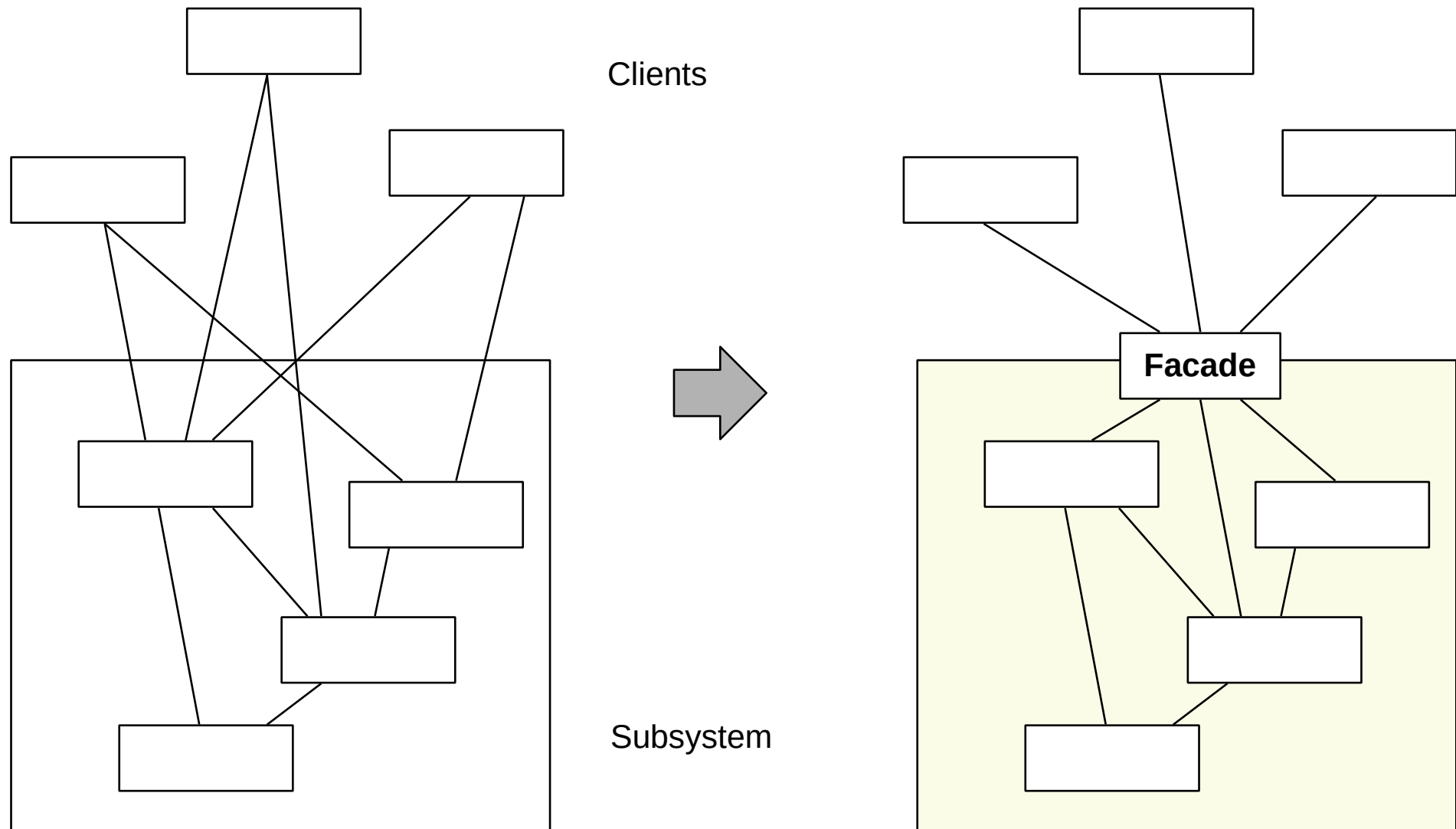



# The Layer Pattern

- ▶ If classes of the subsystem are again facades, **layers** result
  - Layers need nested facades

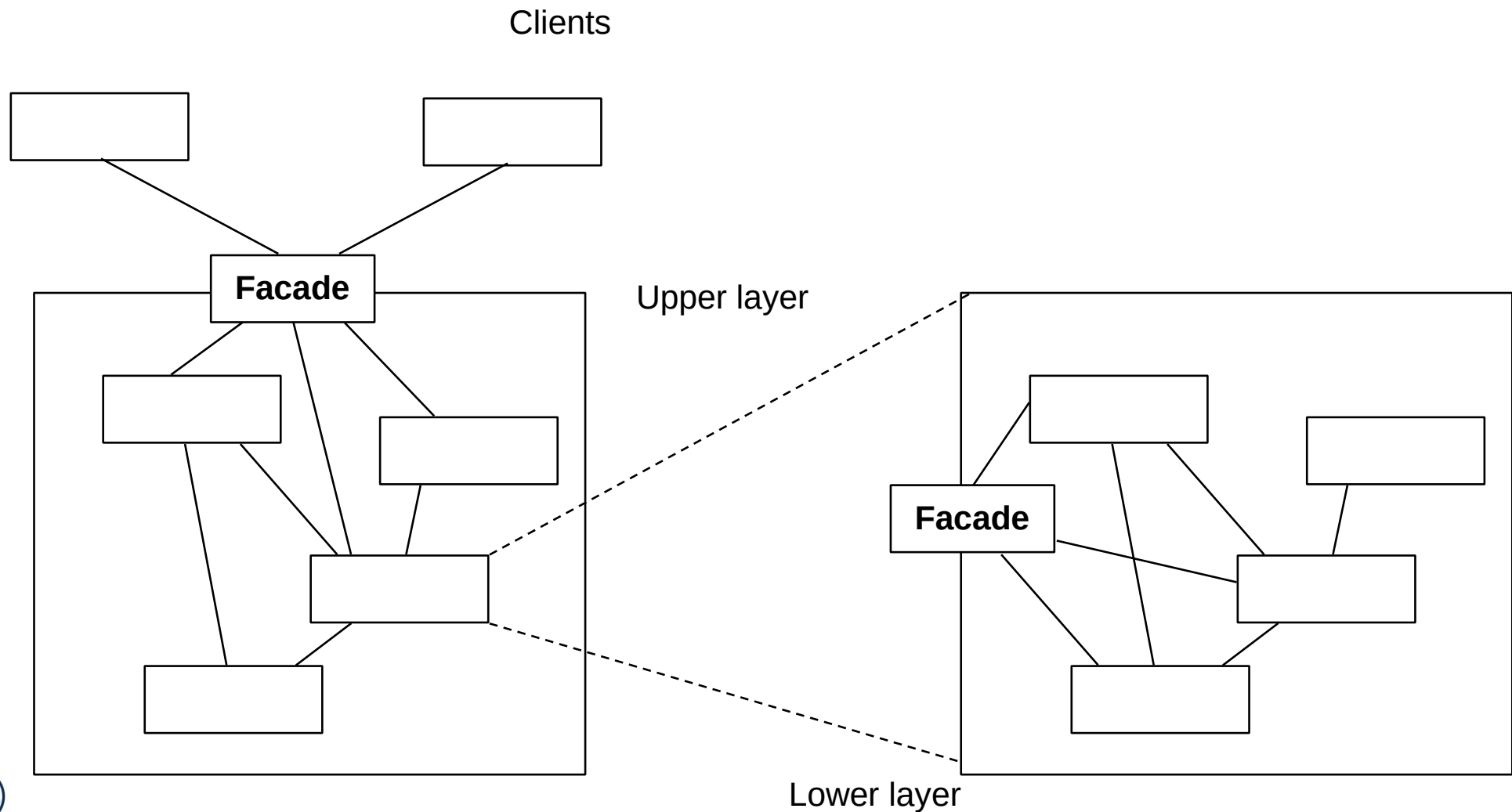

## 24.3.4 Class Adapter

- ▶ Instead of delegation, class adapters use multiple inheritance

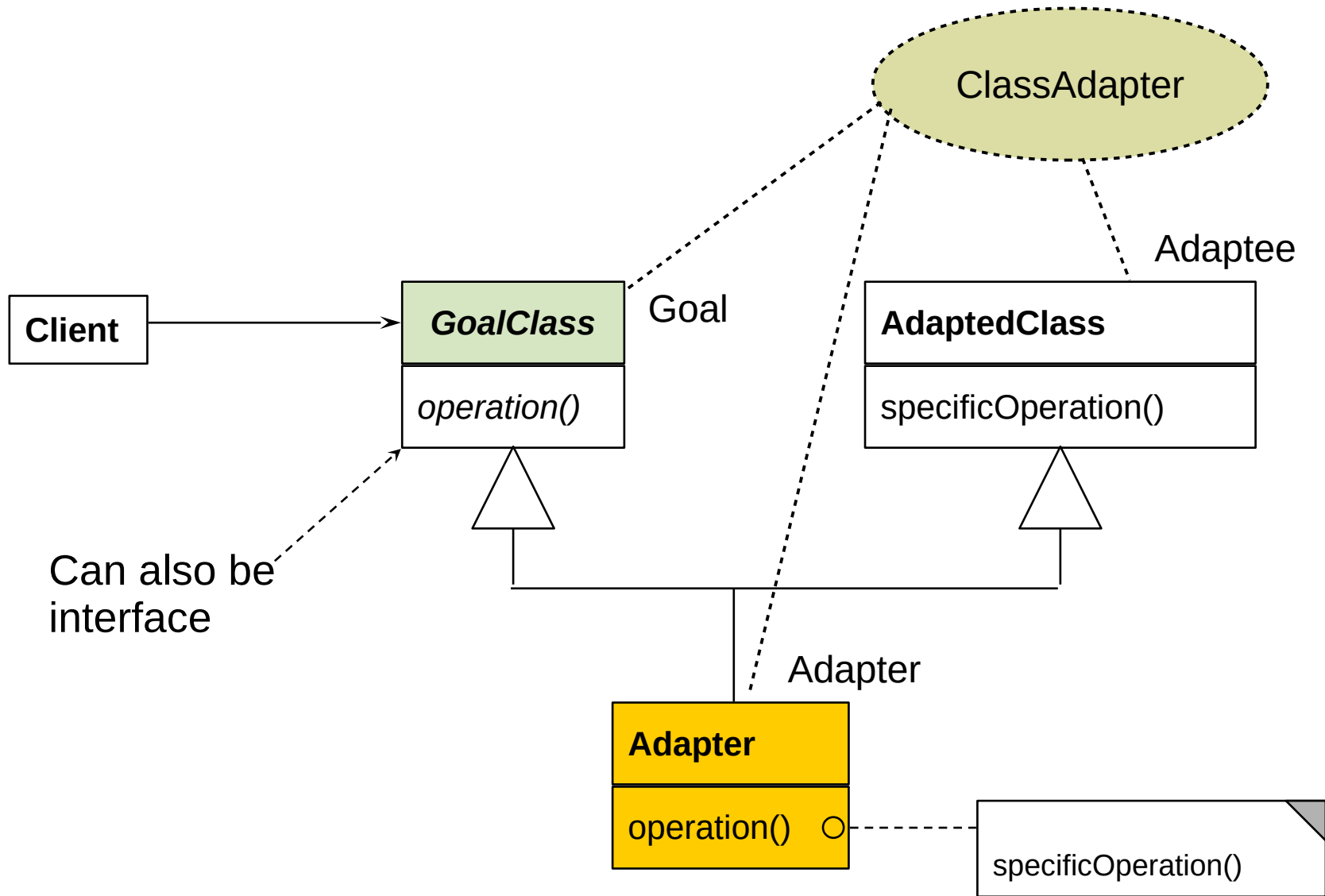

## 24.4 Other Patterns



DRESDEN  
concept  
Exzellenz aus  
Wissenschaft  
und Kultur

# What is discussed elsewhere...

- ▶ Iterator, Sink, and Channel
- ▶ Composite
- ▶ TemplateMethod, FactoryMethod
- ▶ Command

## Part III:

- ▶ Chapter “Analysis”:
  - State (Zustand), IntegerState, Explicit/ImplicitIntegerState
- ▶ Chapter “Architecture”:
  - Facade (Fassade)
  - Layers (Schichten)
  - 4-tier architecture (4-Schichtenarchitektur, BCED)
  - 4-tier abstract machines (4-Schichtenarchitektur mit abstrakten Maschinen)

# Relations between Design Patterns

► For the exam will be needed:

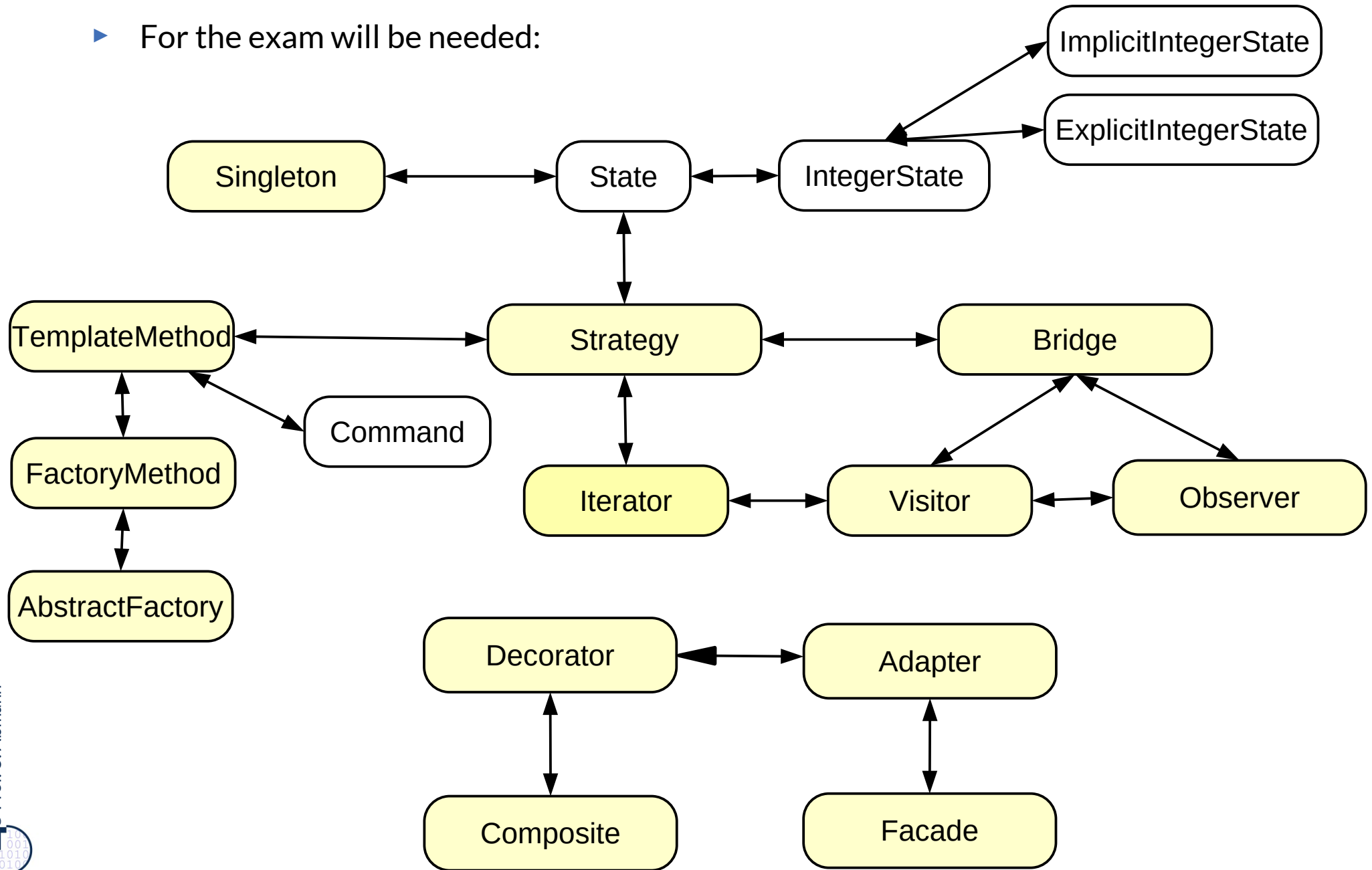

# Other Important GOF Patterns

## Variability Patterns

- ▶ Visitor: Separate a data structure inheritance hierarchy from an algorithm hierarchy, to be able to vary both of them independently
- ▶ AbstractFactory: Allocation of objects in consistent families, for frameworks which maintain lots of objects
- ▶ Builder: Allocation of objects in families, adhering to a construction protocol
- ▶ Command: Represent an action as an object so that it can be undone, stored, redone

## Extensibility Patterns

- ▶ Proxy: Representant of an object
- ▶ ChainOfResponsibility: A chain of workers that process a message

## Others

- ▶ Memento: Maintain a state of an application as an object
- ▶ Flyweight: Factor out common attributes into heavy weight objects and flyweight objects

## 24.5 Design Patterns in a Larger Library



# Design Pattern in the AWT

- ▶ AWT/Swing is part of the Java class library
  - Uniform window library for many platforms (portable)
- ▶ Employed patterns
  - Pull-Observer (for widget super class `java.awt.Window`)
  - Compositum (widgets are hierarchic)
  - Strategy: The generic composita must be coupled with different layout algorithms
  - Singleton: Global state of the library
  - Bridge: Widgets such as `Button` abstract from look and provide behavior
    - Drawing is done by a GUI-dependent drawing engine (pattern bridge)
  - Abstract Factory: Allocation of widgets in a platform independent way



# What Have We Learned?

- ▶ Design Patterns grasp good, well-known solutions for standard problems
- ▶ Variability patterns allow for variation of applications
  - They rely on the template/hook principle
- ▶ Extensibility patterns for extension
  - They rely on recursion
  - An aggregation to the superclass
  - This allows for constructing runtime nets: lists, sets, and graphs
  - And hence, for dynamic extension
- ▶ Architectural Glue patterns map non-fitting classes and objects to each other

## 24.A.1 Proxy



# Proxy

- ▶ Hide the access to a real subject by a representant

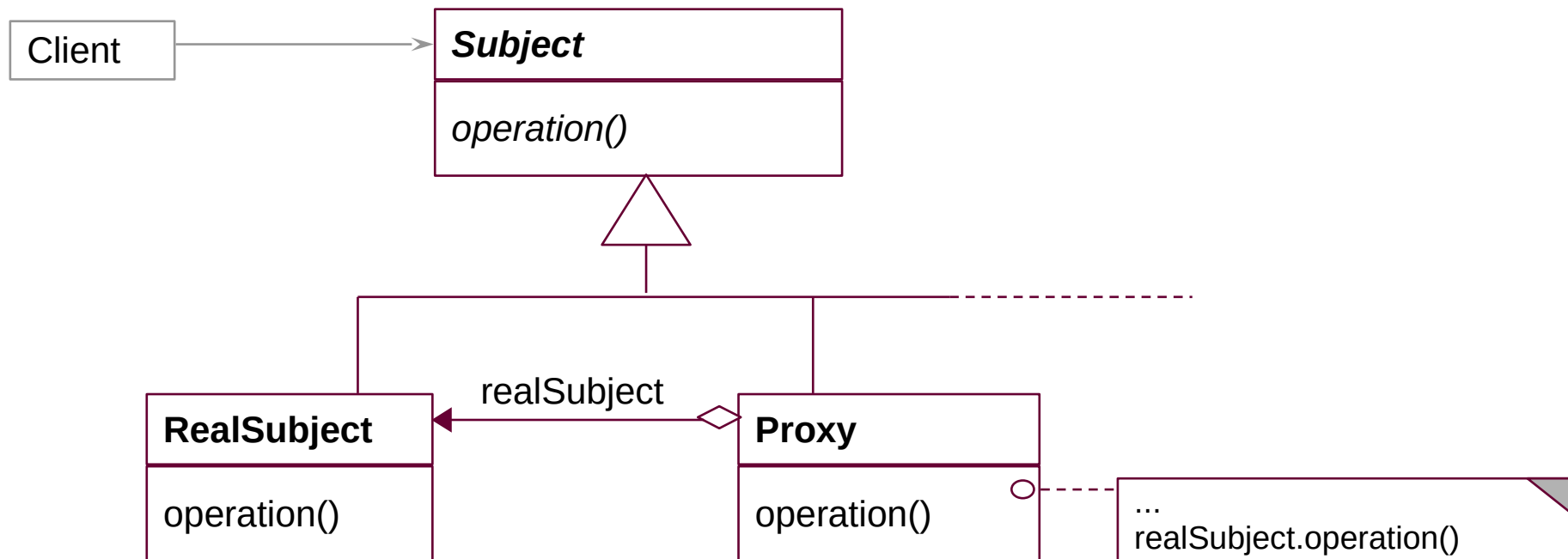

Object Structure:

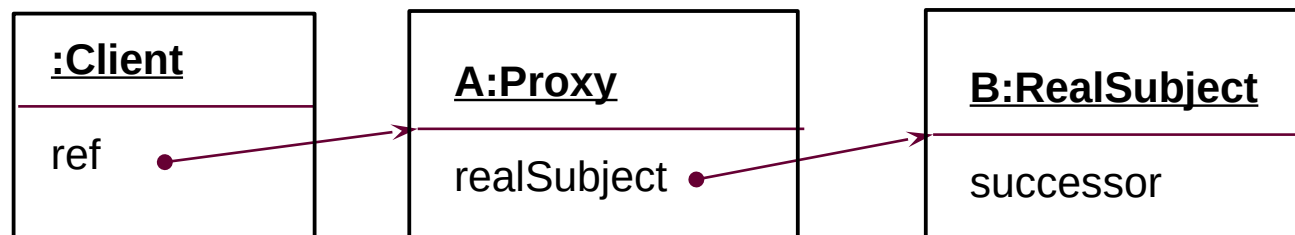

# Proxy

- ▶ The proxy object is a representant of an object
  - The Proxy is similar to Decorator, but it is not derived from ObjectReursion
  - It has a direct pointer to the sister class, *not* to the superclass
  - It may collect all references to the represented object (shadows it). Then, it is a facade object to the represented object
- ▶ Consequence: chained proxies are not possible, a proxy is one-and-only
- ▶ It could be said that Decorator lies between Proxy and Chain.

# Proxy Variants

- ▶ **Filter proxy** (smart reference):
  - executes additional actions, when the object is accessed
- ▶ **Protocol proxy**:
  - Counts references (reference-counting garbage collection)
  - Or implements a synchronization protocol (e.g., reader/writer protocols)
- ▶ **Indirection proxy** (facade proxy):
  - Assembles all references to an object to make it replaceable
- ▶ **Virtual proxy**: creates expensive objects on demand
- ▶ **Remote proxy**: representant of a remote object
- ▶ **Caching proxy**: caches values which had been loaded from the subject
  - Caching of remote objects for on-demand loading
- ▶ **Protection proxy**
  - Firewall proxy

# Adapters and Facades for COTS

- ▶ Adapters and Facades are often used to adapt components-off-the-shelf (COTS) to applications
- ▶ For instance, an EJB-adapter allows for reuse of an Enterprise Java Bean in an application

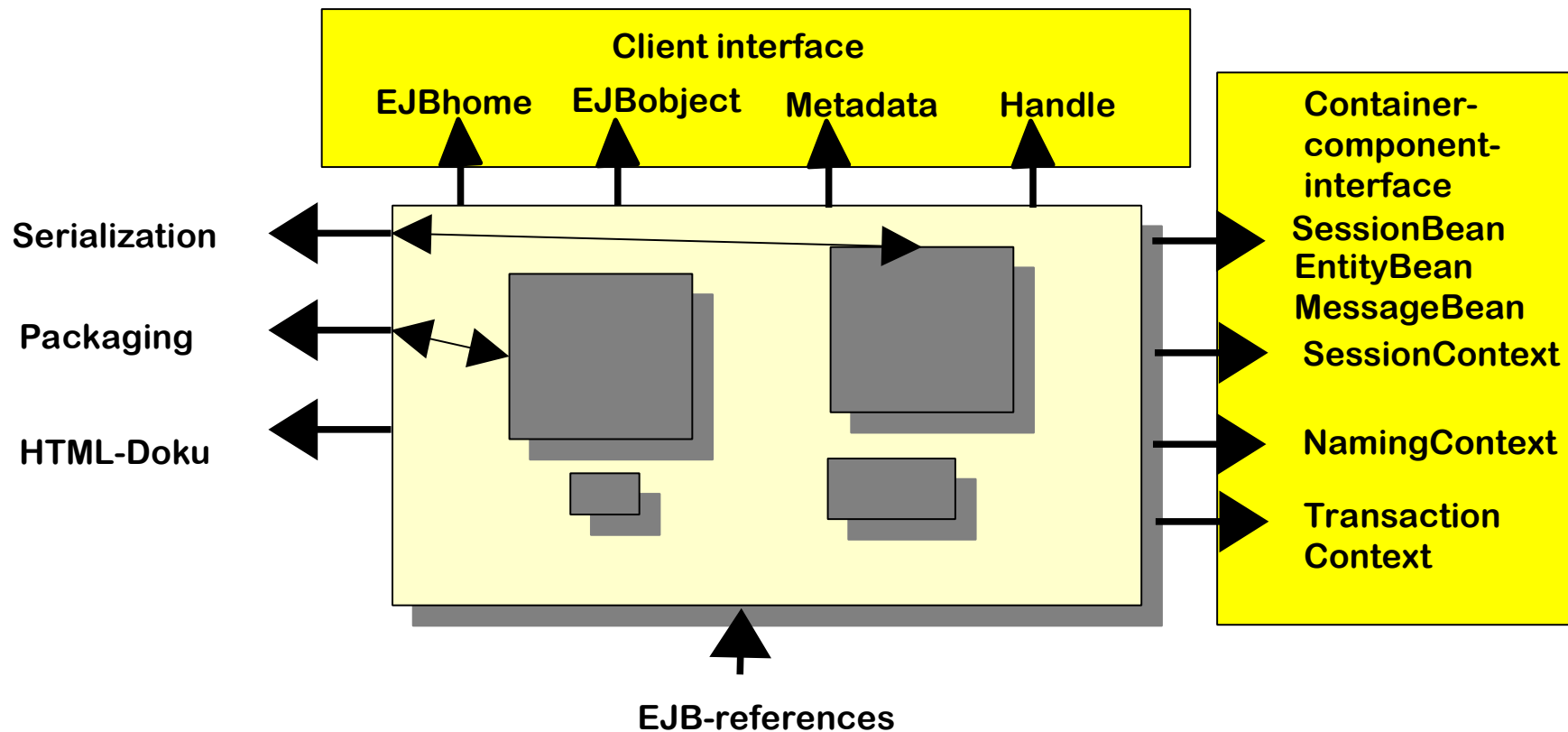

# EJB Adapter

**Client interface**

EJBhome   EJBObject   Metadata   Handle

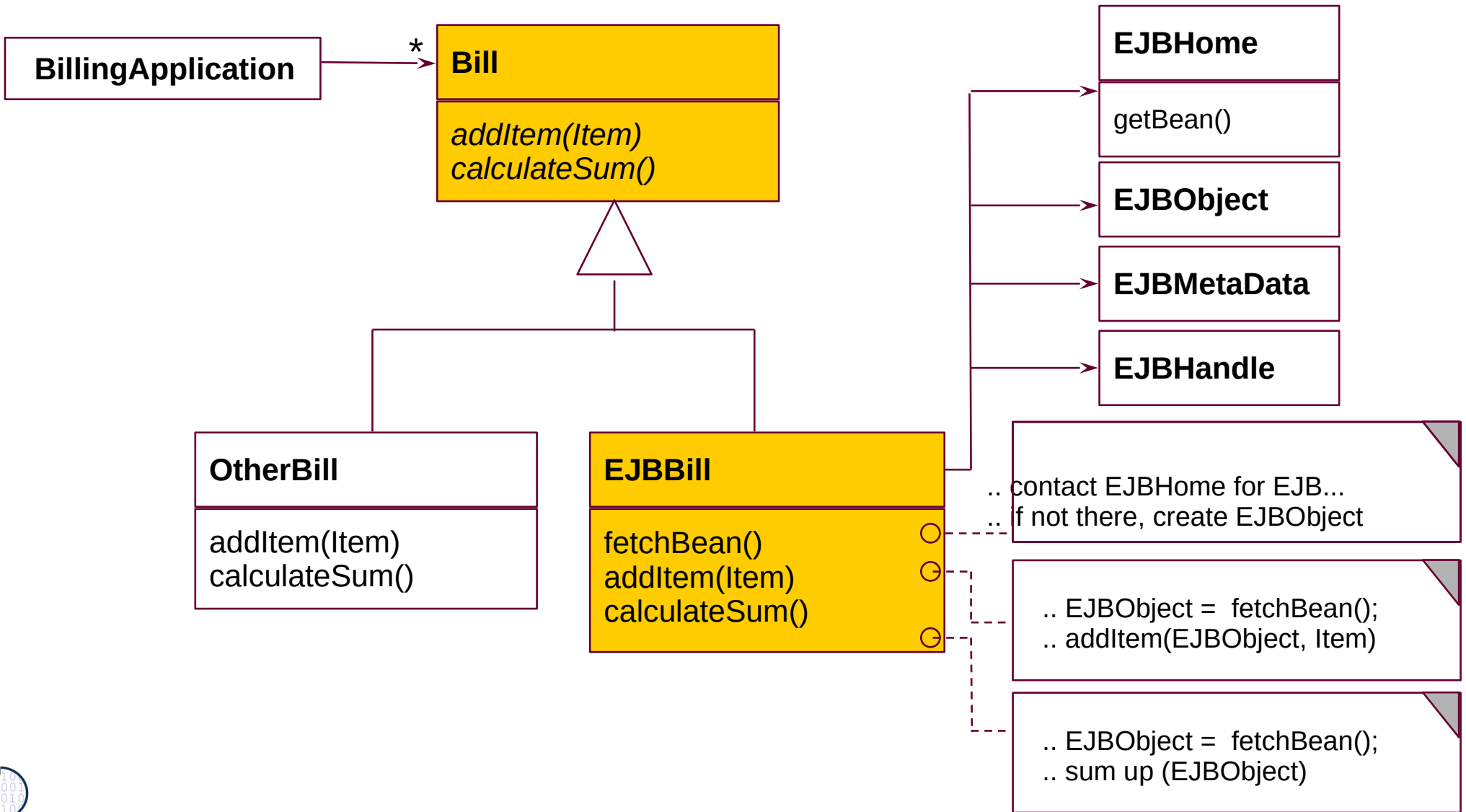

# 24.A.2 Observer with ChangeManager (EventBus)

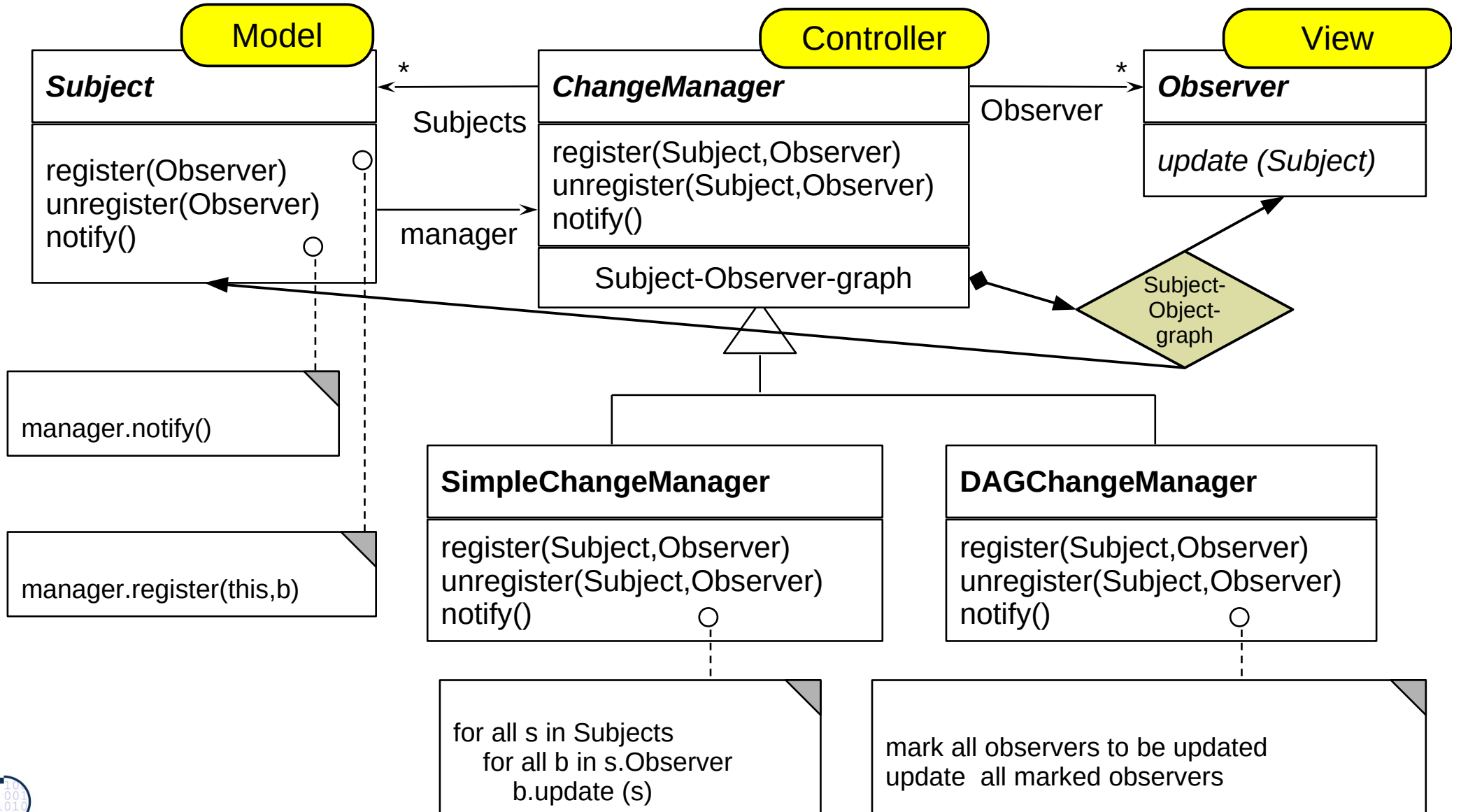



# Observer with ChangeManager is also Called Event-Bus

- ▶ Basis of many interactive application frameworks (Xwindows, Java AWT, Java InfoBus, ...)
- ▶ Loose coupling in communication
  - Observers decide what happens
- ▶ Dynamic extension of communication
  - Anonymous communication
  - Multi-cast and broadcast communication

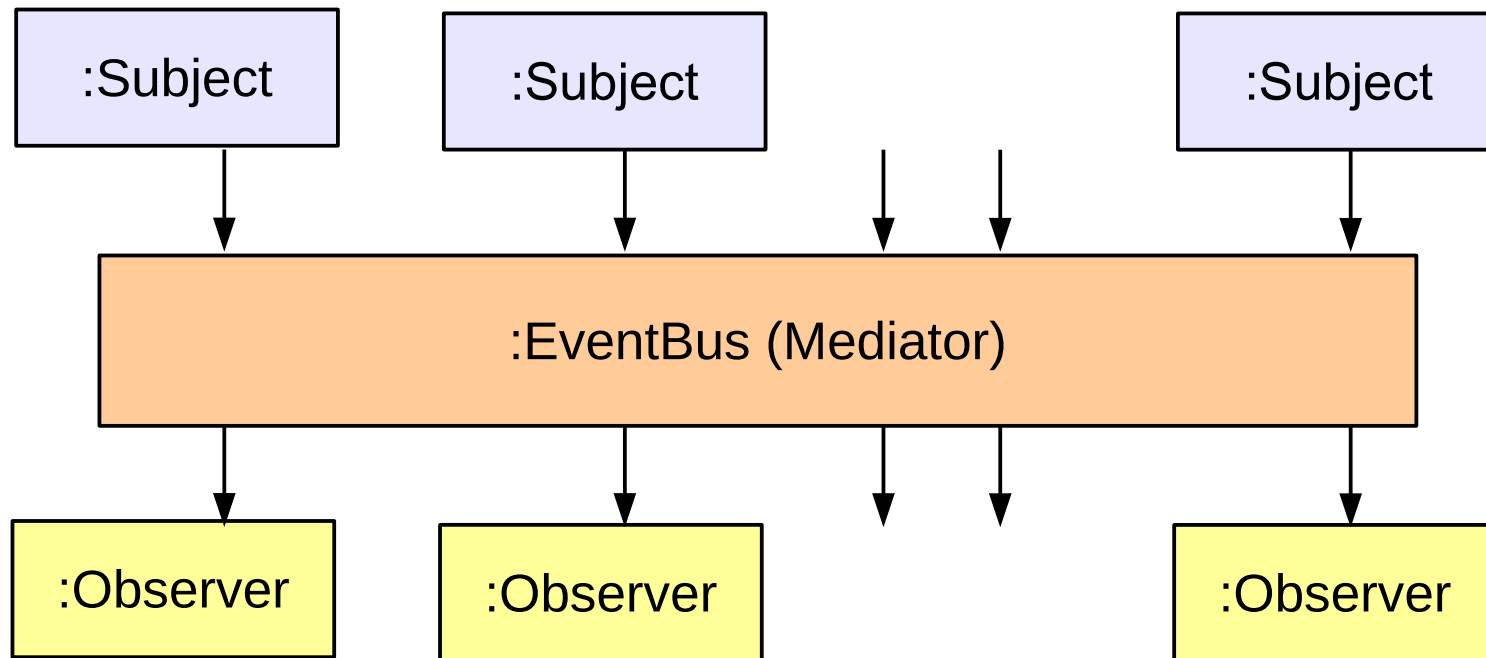

# Why is the Frauenkirche Beautiful?

75

Softwaretechnologie (ST)

- ▶ ..because she contains a lot of patterns from the baroque pattern language...



# The End

- ▶ Design patterns and frameworks, WS, contains more material.
- ▶ © Uwe Aßmann, Heinrich Hussmann, Walter F. Tichy, Universität Karlsruhe, Germany, used by permission

## 24.2.3.7 A Variant of EventBus is the Channel

- ▶ push-Subjects and pull-Observers can be connected by Channel, to emphasize the continuous pushing and pulling
- ▶ Then Subjects write the Sink of the Channel and Observers pull the Stream of the Channel
  - Channel is a buffer

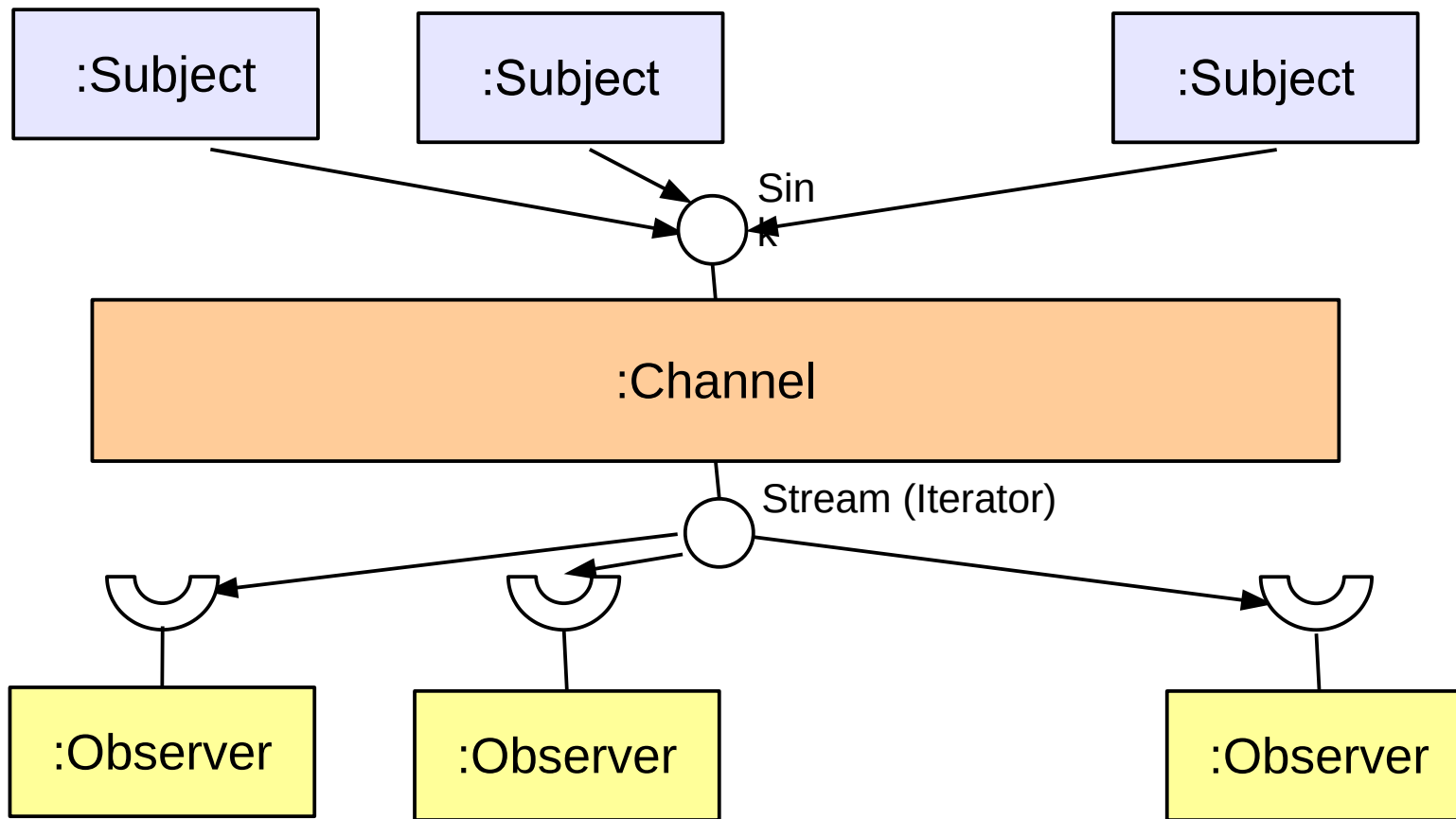

# Appendix



DRESDEN  
concept  
Exzellenz aus  
Wissenschaft  
und Kultur



# Refactorings Transform Antipatterns (Defect Patterns, Bad Smells) Into Design Patterns

- ▶ Software can contain bad structure
- ▶ A DP can be a goal of a *refactoring*, transforming a bad smell into a good smell

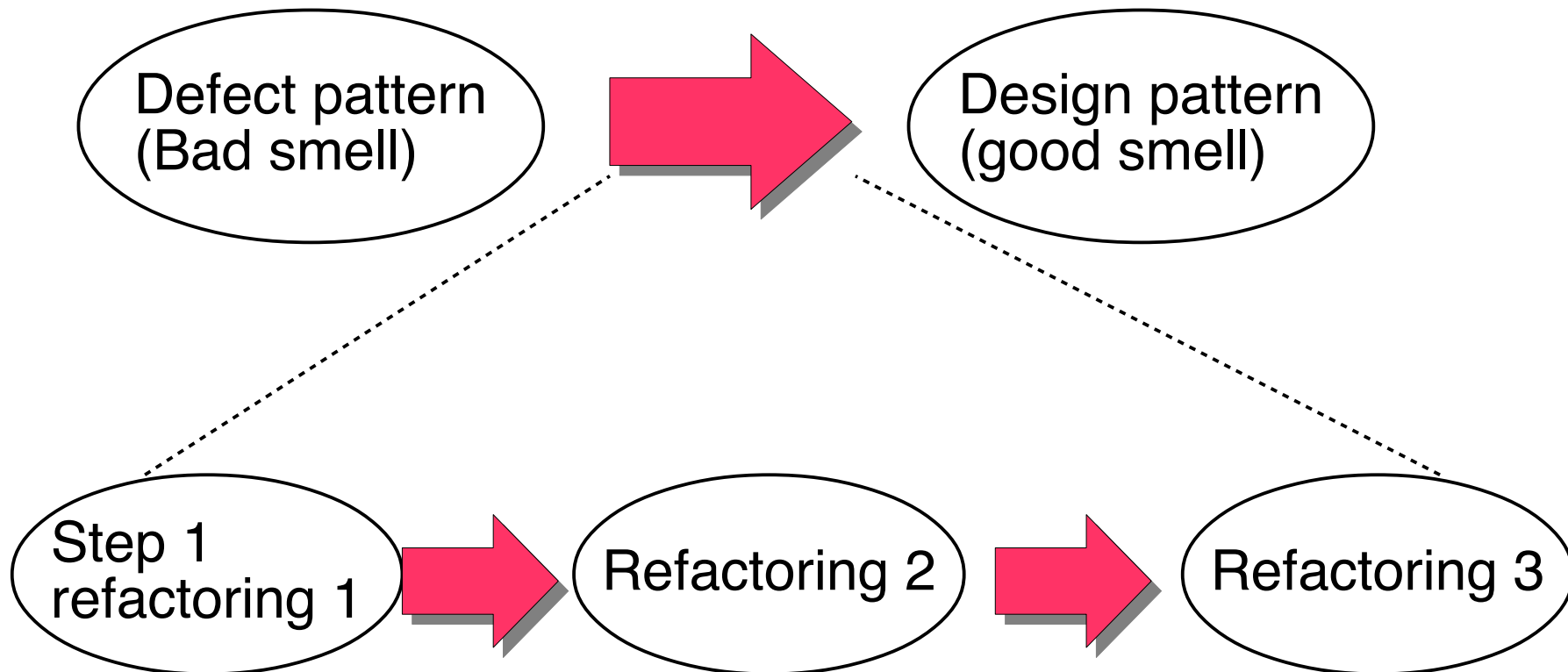

# Structure for Design Pattern Description (GOF Form)

- ▶ Name (incl. Synonyms) (also known as)
- ▶ Motivation (purpose)
  - also “bad smells” to be avoided
- ▶ Employment
- ▶ Solution (the “good smell”)
  - Structure (Classes, abstract classes, relations): UML class or object diagram
  - Participants: textual details of classes
  - Interactions: interaction diagrams (MSC, statecharts, collaboration diagrams)
  - Consequences: advantages and disadvantages (pragmatics)
  - Implementation: variants of the design pattern
  - Code examples
- ▶ Known Uses
- ▶ Related Patterns



# A.2 Example for Composite: PieceLists in Cars

- ▶ Big technical objects can have thousands of parts

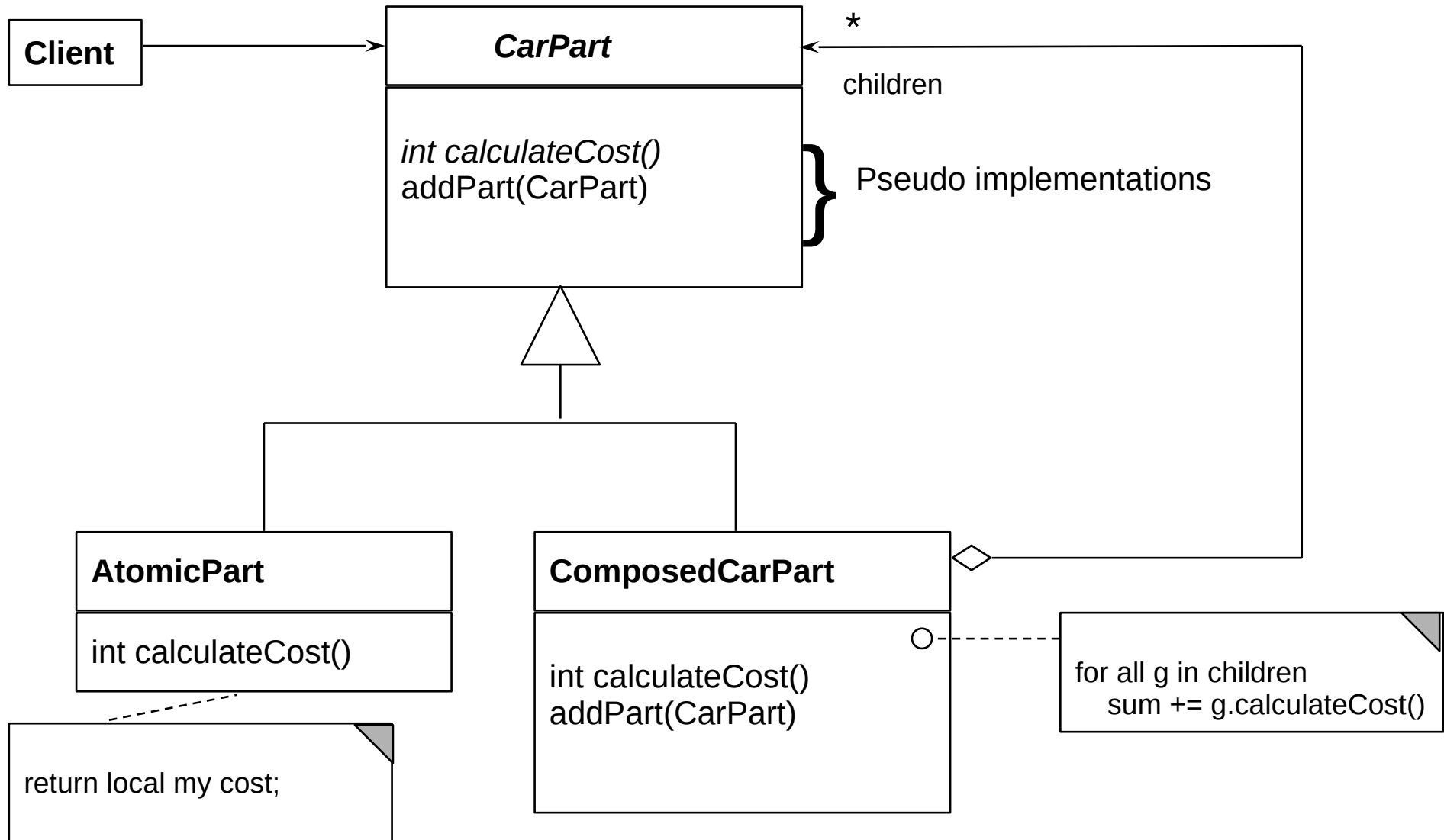

# Piece Lists of Complex Technical Objects

```
abstract class CarPart {
    int myCost;
    abstract int calculateCost();
}

class ComposedCarPart extends CarPart {
    int myCost = 5;
    CarPart [] children; // here is the n-recursion
    int calculateCost() {
        for (i = 0; i <= children.length; i++) {
            curCost += children[i].calculateCost();
        }
        return curCost + myCost;
    }
    void addPart(CarPart c) {
        children[children.length] = c;
    }
}
```

```
class AtomicCarPart extends CarPart {
    int calculateCost() { return myCost; }
    void addPart(CarPart c) {
        /// impossible, dont do anything
    }
}

class Screw extends AtomicCarPart {
    int myCost = 10;
}

class SteeringWheel extends AtomicCarPart {
    int myCost = 200;
}
```

```
// application
int cost = carPart.calculateCost();
```

Iterator algorithms (map)  
Folding algorithm (folding a tree with a scalar function)

# Composite for Part/Whole Hierarchies (Structured Piece Lists)

- ▶ Part/Whole hierarchies, e.g., nested graphic objects (widgets)
- ▶ Dynamic Extensibility of Composite
  - Due to the n-recursion, new children can always be added dynamically into a composite node
  - Whenever you have to program an extensible part of a framework, consider Composite

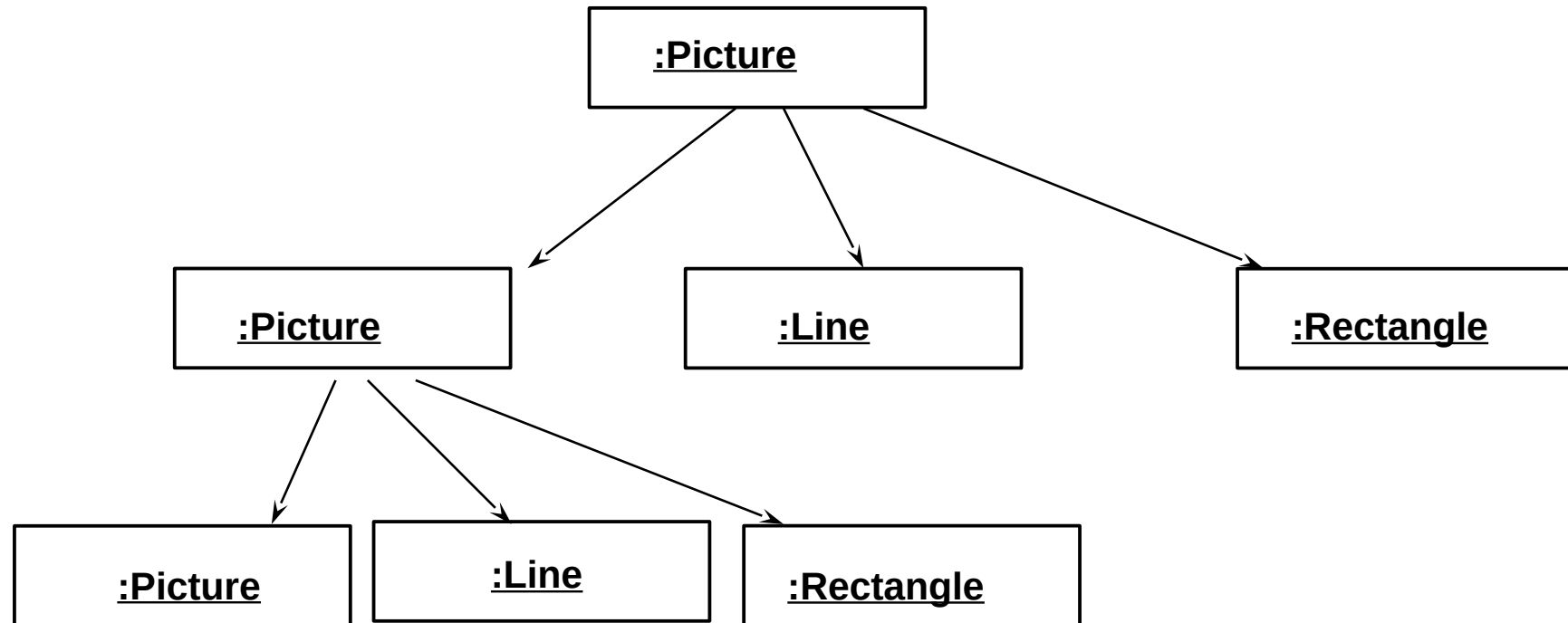

common operations: draw(), move(), delete(), scale()