

12. Frameworks and Patterns - Framework Extension Patterns



Prof. Dr. U. Aßmann
Software Engineering Group
Faculty of Informatics
Dresden University of
Technology
Version 11-0.3, 12/10/11

1) Extension Object Pattern
2) Large Layered Frameworks
3) Role Object Pattern
4) GenVoca Pattern
5) Mixin Layer Pattern
6) Concerns for Layered Frameworks



Design Patterns and Frameworks, © Prof. Uwe Aßmann

1

Literature (To Be Read)

- ▶ E. Gamma. The Extension Objects Pattern. Conf. On Pattern Languages of Programming (PLOP) 97, ACM. <http://portal.acm.org/citation.cfm?id=273448.273455#>
- ▶ Y. Smaragdakis and D. Batory. Mixin layers: an object-oriented implementation technique for refinements and collaboration-based designs. ACM Transactions on Software Engineering and Methodology, 11(2):215–255, 2002.
- ▶ D. Bäumer, D. Riehle, W. Silberski, M. Wulf. Role Object. Conf. On Pattern Languages of Programming (PLOP) 97. <http://citeseer.ist.pst.edu/baumer97role.html>
- ▶ D. Riehle, T. Gross. Role Model Based Framework Design and Integration. Proc. 1998 Conf. On Object-oriented Programming Systems, Languages, and Applications (OOPSLA 98) ACM Press, 1998. <http://citeseer.ist.pst.edu/riehle98role.html>
- ▶ D. Bäumer, G. Gryczan, C. Lilienthal, D. Riehle, H. Züllighoven. Framework Development for Large Systems. Communications of the ACM 40(10), Oct. 1997. <http://citeseer.ist.pst.edu/bumer97framework.html>



Further Literature

- ▶ D. Bäumer. Softwarearchitekturen für die rahmenwerkbasierete Konstruktion grosser Anwendungssysteme. PhD thesis, 1997, Universität Hamburg.
- ▶ JWAM sites
 - <http://www.c1-wps.de/forschung-und-lehre/fachpublikationen/>
 - www.jwam.de
 - <http://sourceforge.net/projects/jwamtoolconstr/>
- ▶ U. Aßmann. Composing Frameworks and Components for Families of Semantic Web Applications. Lecture Notes In Computer Science, vol. 2901, Nov. 2003.
- ▶ U. Aßmann, J. Johannes, J. Henriksson, and I. Savga. Composition of rule sets and ontologies. In F. Bry, editor, Reasoning Web, Second Int. Summer School 2006, number 4126 in LNCS, pages 68-92, Sept 2006. Springer.
- ▶ Y. Smaragdakis, D. Batory. Mixin Layers: An object-oriented implementation for refinements and collaboration-based designs.
- ▶ Y. Smaragdakis, D. Batory. Implementing layered designs with mixin layers. In Lecture Notes in Computer Science (LNCS) 1998, Springer-Verlag.

Goal

- ▶ Studying extensible framework hook patterns
 - Understand patterns Extensions Object, Role Object, and Genvoca
 - See how layered frameworks can be implemented by Role Object and Genvoca
- ▶ Understand these patterns as extension points of frameworks, i.e., framework hook patterns

Frameworks Must Be Extensible

- ▶ Frameworks must evolve, be adapted
- ▶ Idea: instead of variability hooks, use extensibility hooks
 - based on basic extensibility patterns
- ▶ Presented in this lecture:
 - Gamma's Extension Object Pattern (EOP)
 - Layered frameworks
 - Riehle/Züllighoven's RoleObject pattern (ROP)
 - Batory's mixin layer pattern (GenVoca pattern)

12.1 The ExtensionObjects Pattern (EOP)



Structure of ExtensionObjects

- ▶ Whenever a complex object has non-mandatory parts that can be added, if necessary
- ▶ *Extension* is the base class of all extensions
- ▶ *AbstractExtension* defines an interface for a concrete hierarchy of extension objects
- ▶ Extensions can be added, retrieved, and removed by clients

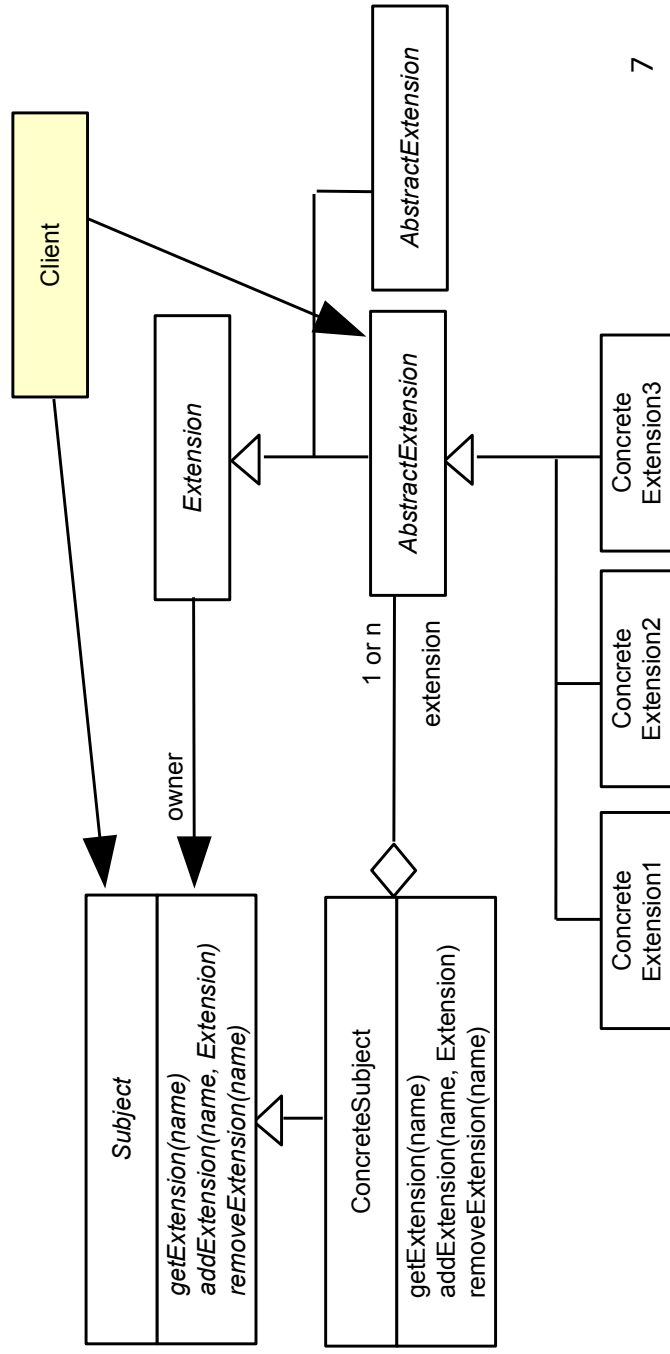

Example: Spellcheckers in Document Models

- ▶ E.g., OpenDoc or OLE documents

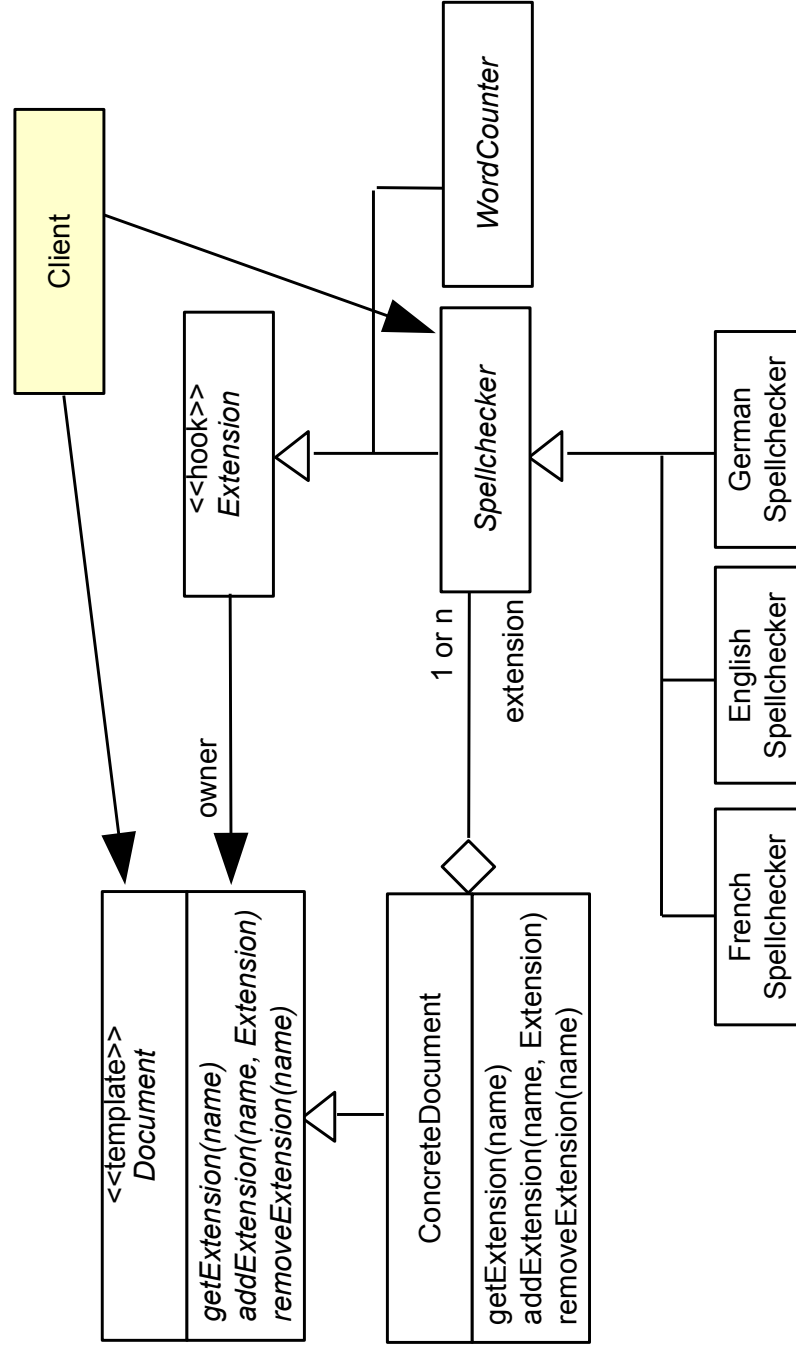

Discussion of EOP

- ▶ If there is 1 extension object, naming is not necessary
- ▶ If there are n extension objects, a dictionary (map) has to map names to extension objects
- ▶ Advantages
 - Complex objects can be split into simpler parts
 - Extensions can model (optional) roles of objects
 - Extensions can be added dynamically and unforeseen
- ▶ Disadvantage
 - Clients have to manage extension objects themselves, and hence, are more complex
 - Extension objects suffer from the *object schizophrenia* problem: the logical *this* of an extension object is the subject, but the physical *this* is the extension object
- ▶ **Relations to Other Patterns**
 - If many objects of an application have the same roles that are realized by extension objects, ExtensionObjects can be generalized to the Role Object Pattern

ExtensionObjects at Framework Borders

- ▶ Since with EOP, clients have to manage extensions themselves, the use of the template object in the framework does not help to use the hook objects

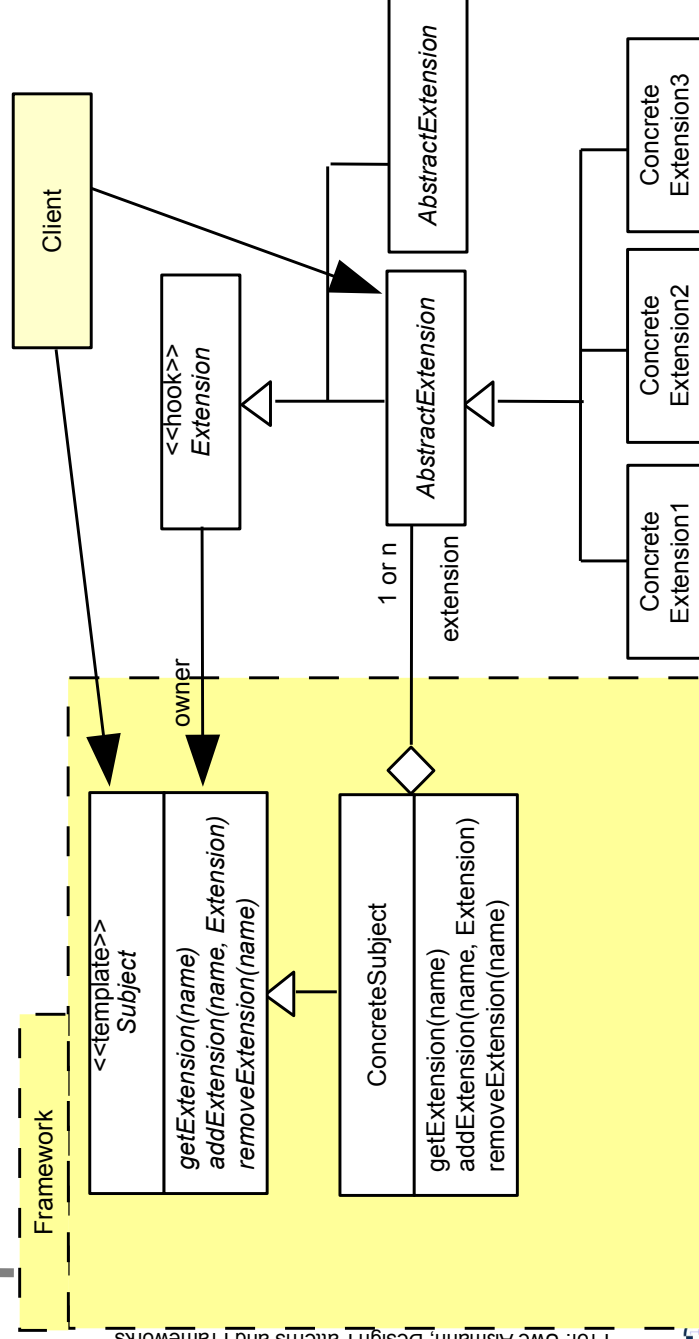

EOP as Framework Hook Pattern

- ▶ Since the hook object is not mandatory, also 1-H=T is a real extensibility pattern for frameworks

1-H=T

T has 1 H part
T owns H

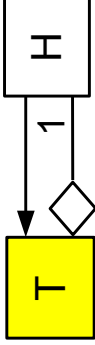

n-H=T

T has n H parts
T owns H parts

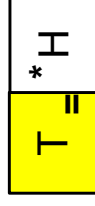
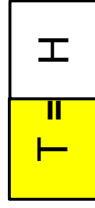
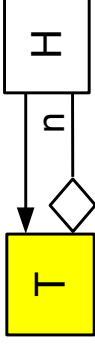

Optional Tools for Documents in an Office Framework

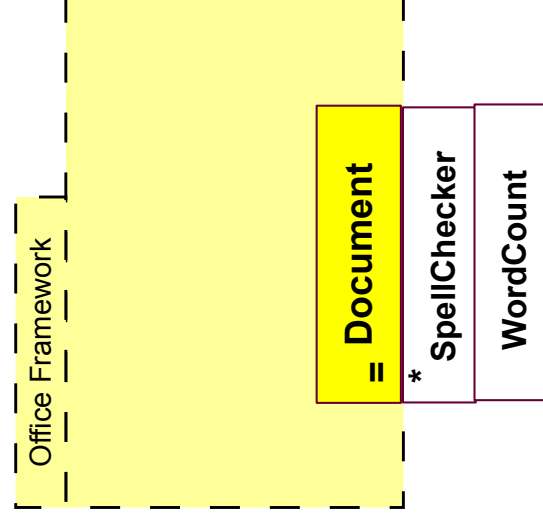

a.s.o



12.2 Extensibility of Frameworks with Layers

... with Layered Role Object Frameworks



Design Patterns and Frameworks, © Prof. Uwe Alßmann

13

Case Study GEBOS

- ▶ GEBOS is a banking application for RWG banking group with 450 banks, south of Germany
 - Banking applications, with services: tellers, loans, stocks, investment, self-service
 - 2500 C++ classes, arranged in frameworks, Arranged in layers
- ▶ Concepts of the bank application domain
 - Banks organize themselves in **business sections** (tellers, loans, etc.)
 - Department of specialists that have a certain expertise (loans, teller, investment)
 - **Workplace contexts**
 - Service centers offer customers an all-in-one service
 - Services of the business sections
 - Every workplace needs different application systems
 - **Business domain**
 - Business objects such as bill, order, account



Application Framework Layers

- ▶ Gebos demonstrates that it is advantageous to structure an application framework into layers
 - Application layers, Business Section layers, Business domain layers
 - Desktop Layer, Technical kernel layer

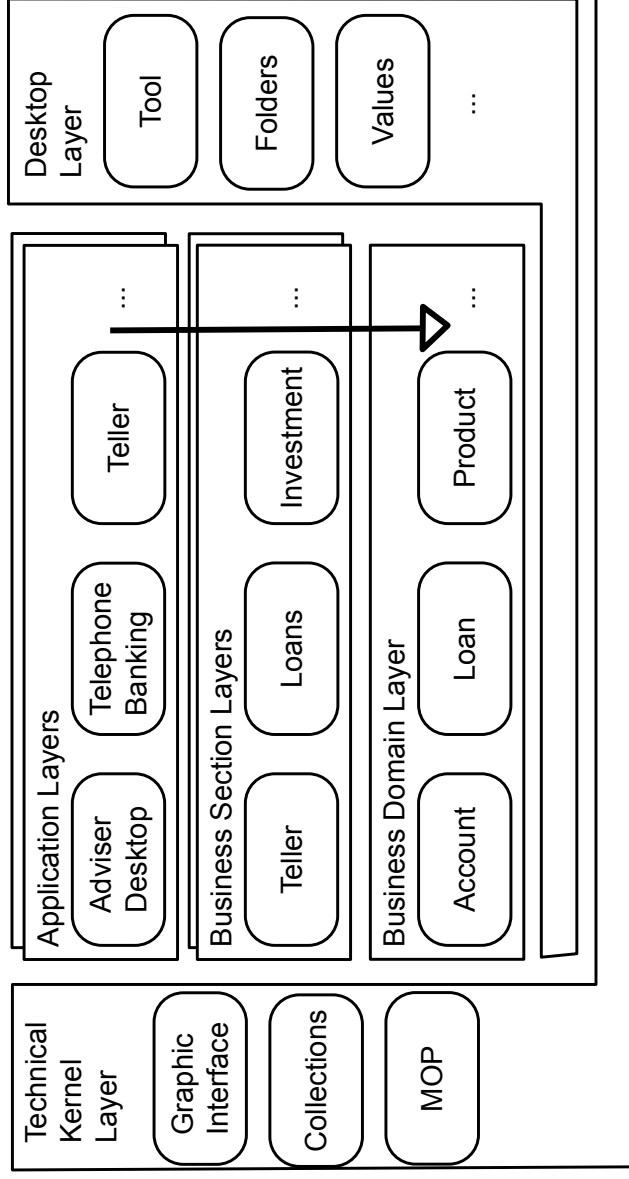

Layers

- ▶ **Technical Kernel Layer**
 - Service layer, independent of other layers
 - Domain independent, application independent
 - Is a framework itself
 - Collections
 - Middleware
 - Wrappers
 - Garbage collection, late creation, factories, trace support
 - Is a blackbox framework
- ▶ **Desktop Layer**
 - Support for interactive workplaces
 - Contains a tool construction framework (for the Tools&Materials approach)
 - MVC framework, Folder framework, Value framework for business and domain values
 - AccountNumber, clientNumber, Money etc
 - Look and feel, reusable for office domains with GUI applications

Layers

- ▶ **Business Domain Layer** contains the business core concepts: Account, customer, product, value types
 - Shares knowledge for all business sections
 - Think about how to divide the knowledge between business domain layer and business section layers
- ▶ **Business Section Layers**
 - Subclassing business domain and desktop layers, “inherits” knowledge from both
 - Business section concepts: Borrower, investor, guarantor, loan, loan account, tools. Organizational entities and notions
 - Distinguish from business domain
- ▶ **Application Layers**
 - Application concepts
 - Separate from Business Sections, because workplaces need different functionality from different business sections
 - Uses (and inherits) from all other layers

Goals in Framework Design of GEBOS

- ▶ Minimize coupling between frameworks and application systems
 - Frameworks should never be touched when developing an application system
- ▶ Model different facets of business sections, products, and business domain concepts
 - Use role-object design pattern
- ▶ Minimize coupling between the layers
 - Separate concepts from implementation
 - Move implementation to lower layers
- ▶ Achieved with the RoleObject pattern



12.3 The RoleObject Pattern



Framework Extensibility with Riehles Role-Object Layers

- ▶ The Role-Object Pattern (ROP) is both a variability and extensibility pattern
 - Realizes the “dispatch on all layers” for application frameworks
 - Can easily be extended with new layers
- ▶ Extension of a core layer (a blackbox framework of core objects) with layers of delegates (role objects)
 - A **conceptual object (complex object, subject)** of the application is split over all layers
 - **Core** and **role** objects conceptually belong together to the **conceptual** object, but distribute over the layers
 - Role objects are *views* on the conceptual object

Riehle/Züllighovens Role Object Pattern (ROP)

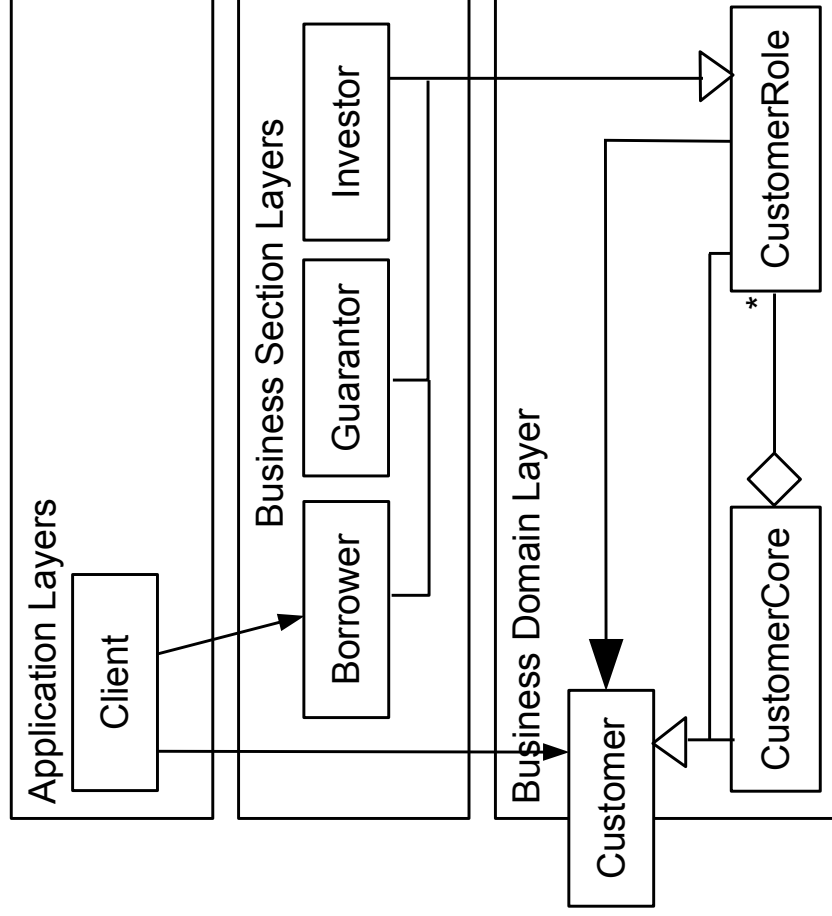

Role Object Pattern with Inheritance Drawn Upwards

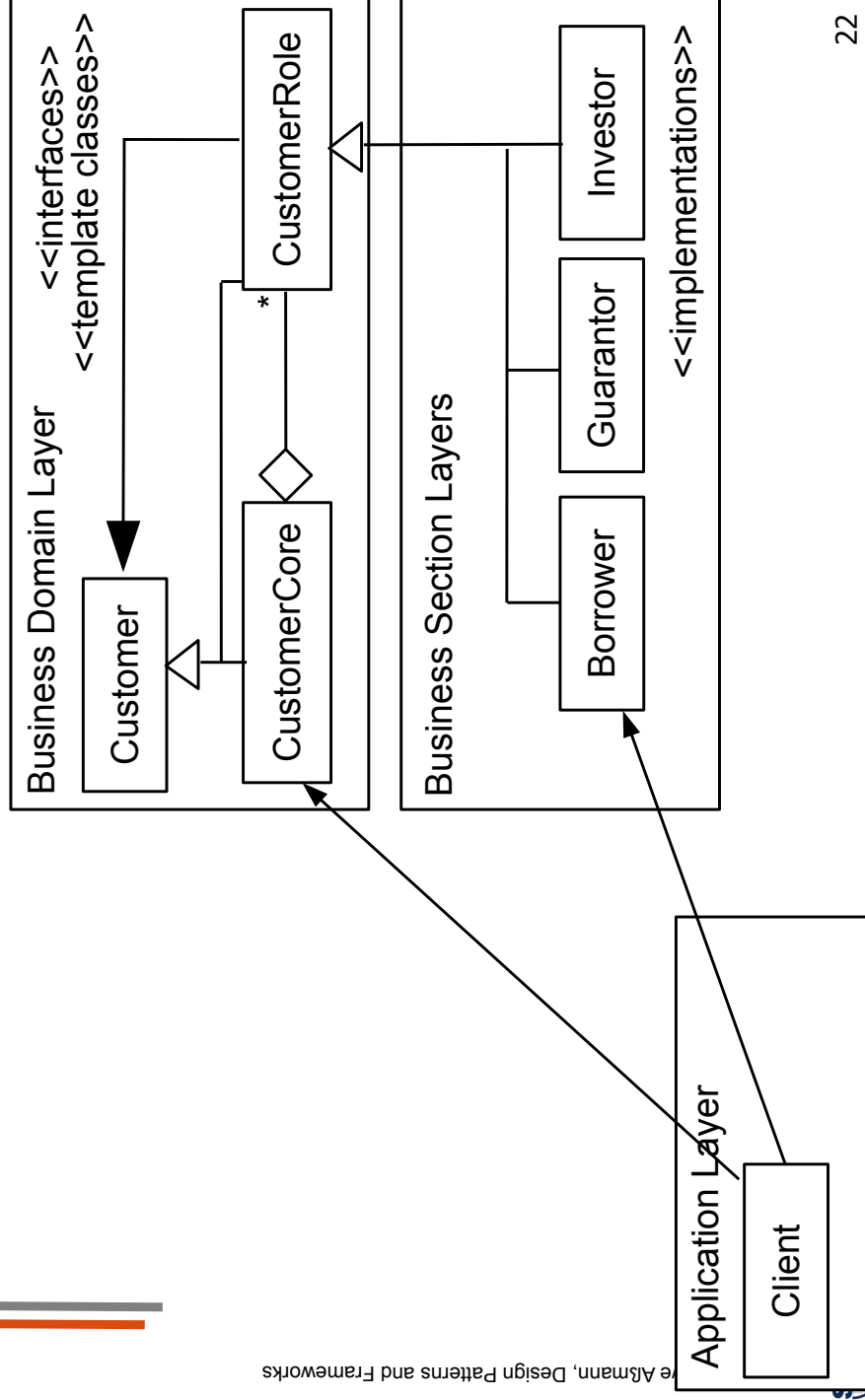

Runtime Behavior

- ▶ At runtime, RoleObjects pass service requests (queries) on to the core
- ▶ The core knows all RoleObjects, and distributes requests (Mediator)
 - The core manages RoleObjects in a map that can be dynamically extended

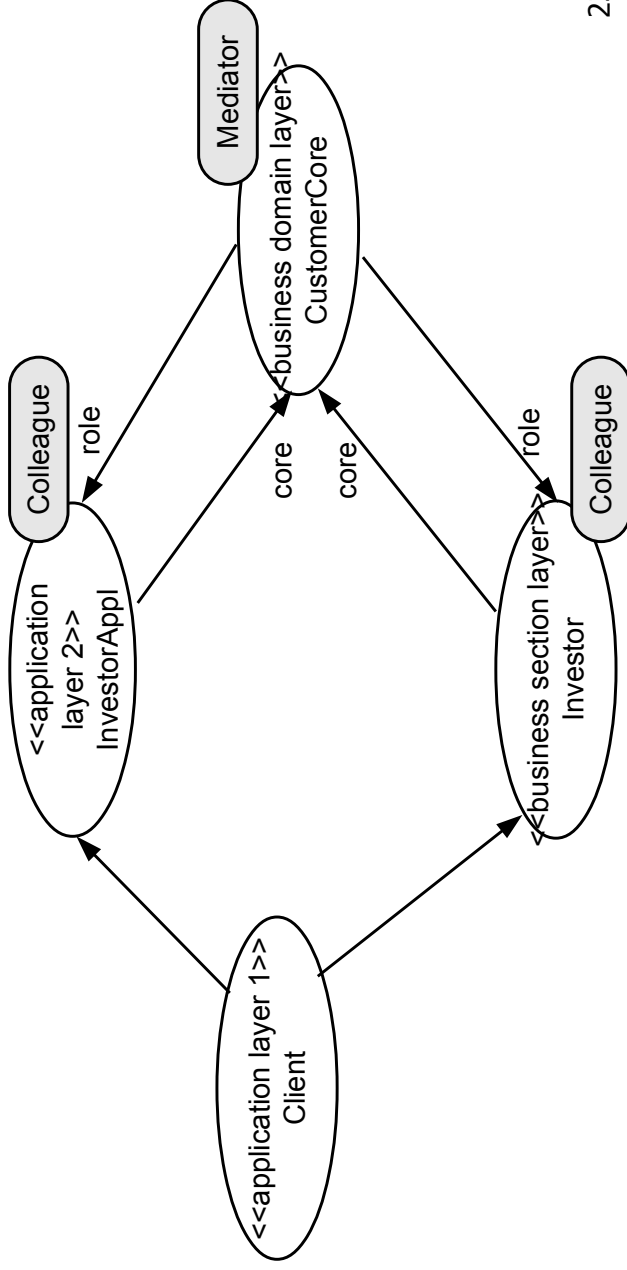

Riehle/Züllighovens Role Object Pattern Abstracted

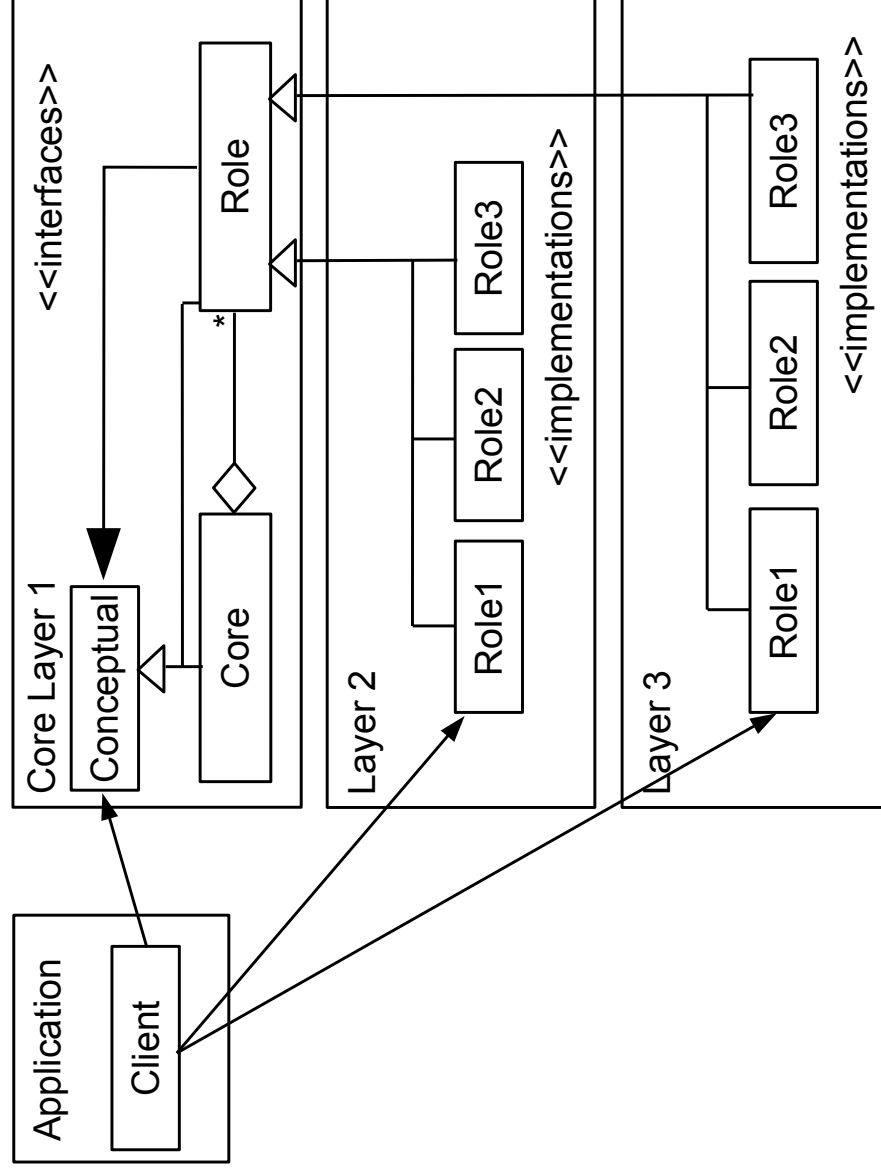

Riehle/Züllighovens Role Object Pattern Variant 2

- Variant 2 has no Decorator; roles only know cores

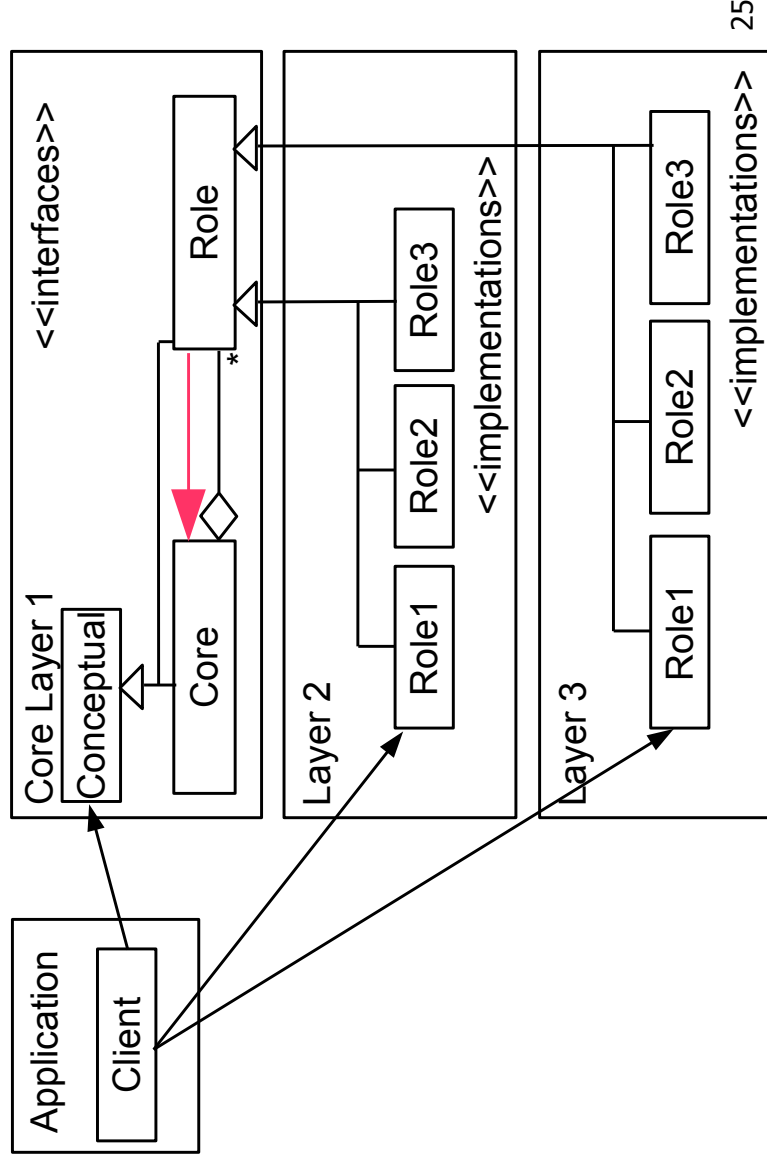

25

Structure of Core Layer

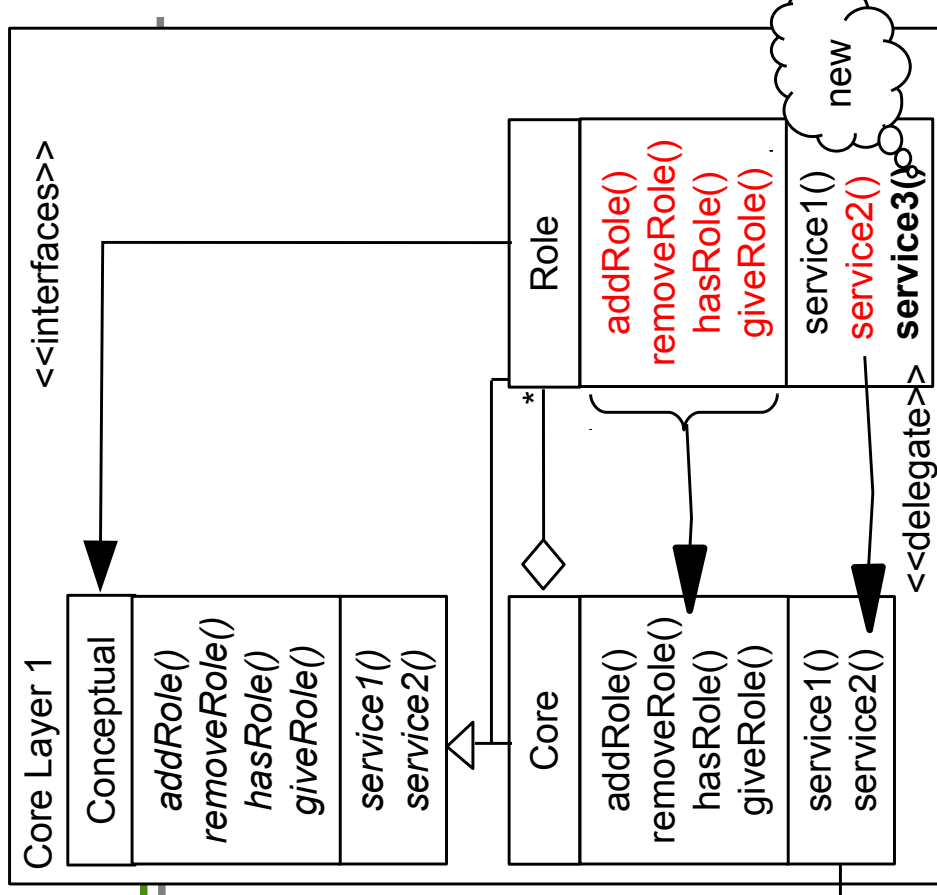
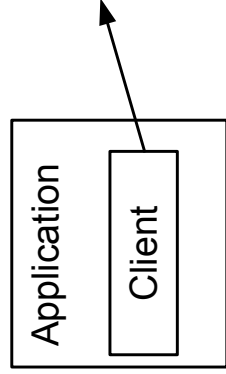

26

Run-time Behavior of ROP

- ▶ Different Role Objects may belong to the same role type (same ability)
- ▶ Over time, the role object for a role type may change, due to polymorphic behavior of the role
 - This expresses states of the role type in the application
 - E.g., Borrower --> UnsafeBorrower --> TrustedBorrower
- ▶ Roles are created on-demand
 - In the beginning, the Subject is *slim*, i.e., carries few roles.
 - At service requests, the core creates roles and enters them in the role map

Core Layer with Traded Call

- ▶ To add services dynamically (beyond the service interfaces in the conceptual object), add a *trader*
 - A method that interprets a service request based on a service description

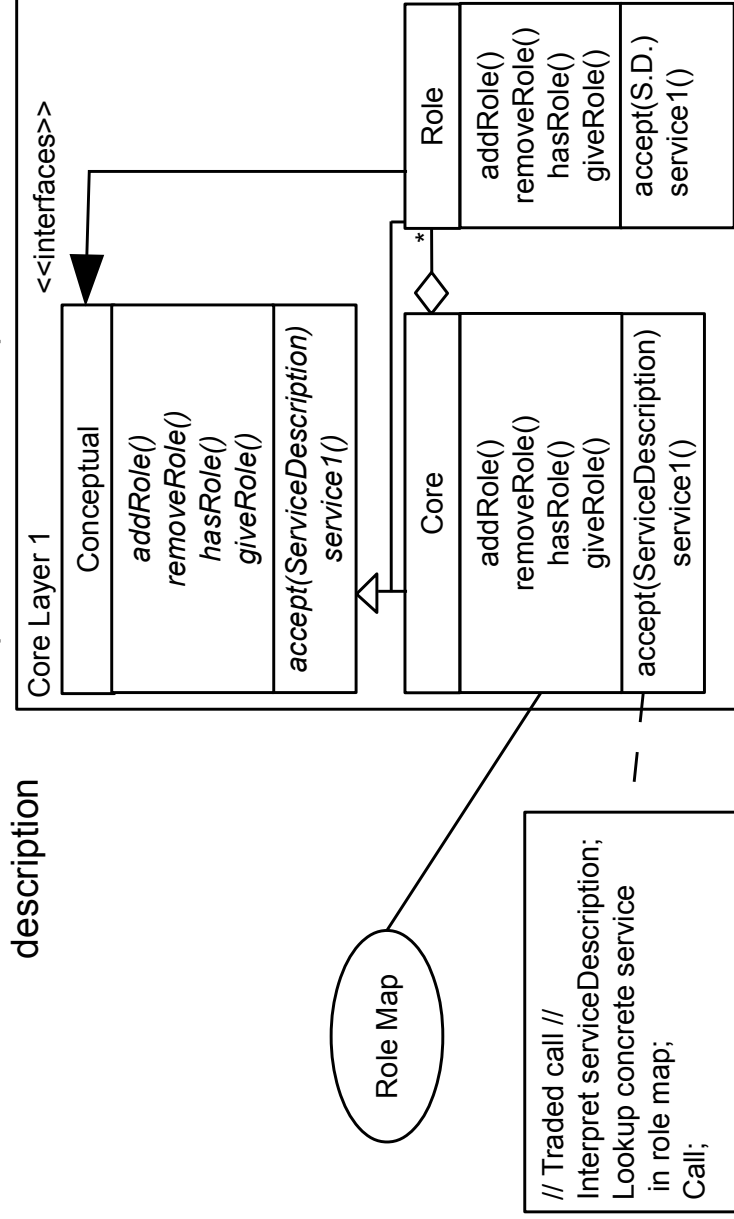

RoleObject and Other Patterns

- ▶ Role object pattern is not only a Decorator
 - It is based on $1-H \leq T$, i.e., 1-ObjectRecursion
 - All role objects inherit from the abstractum
 - Remember, 1-ObjectRecursion based patterns lend themselves to extension
 - And $1-H \leq T$ framework hook patterns provide extensible frameworks
 - 1:n relationship between core and role objects
 - Role objects decorate the core object, and pass requests on to it

Role Object Pattern Vs Inheritance (White-Box Framework Layers)

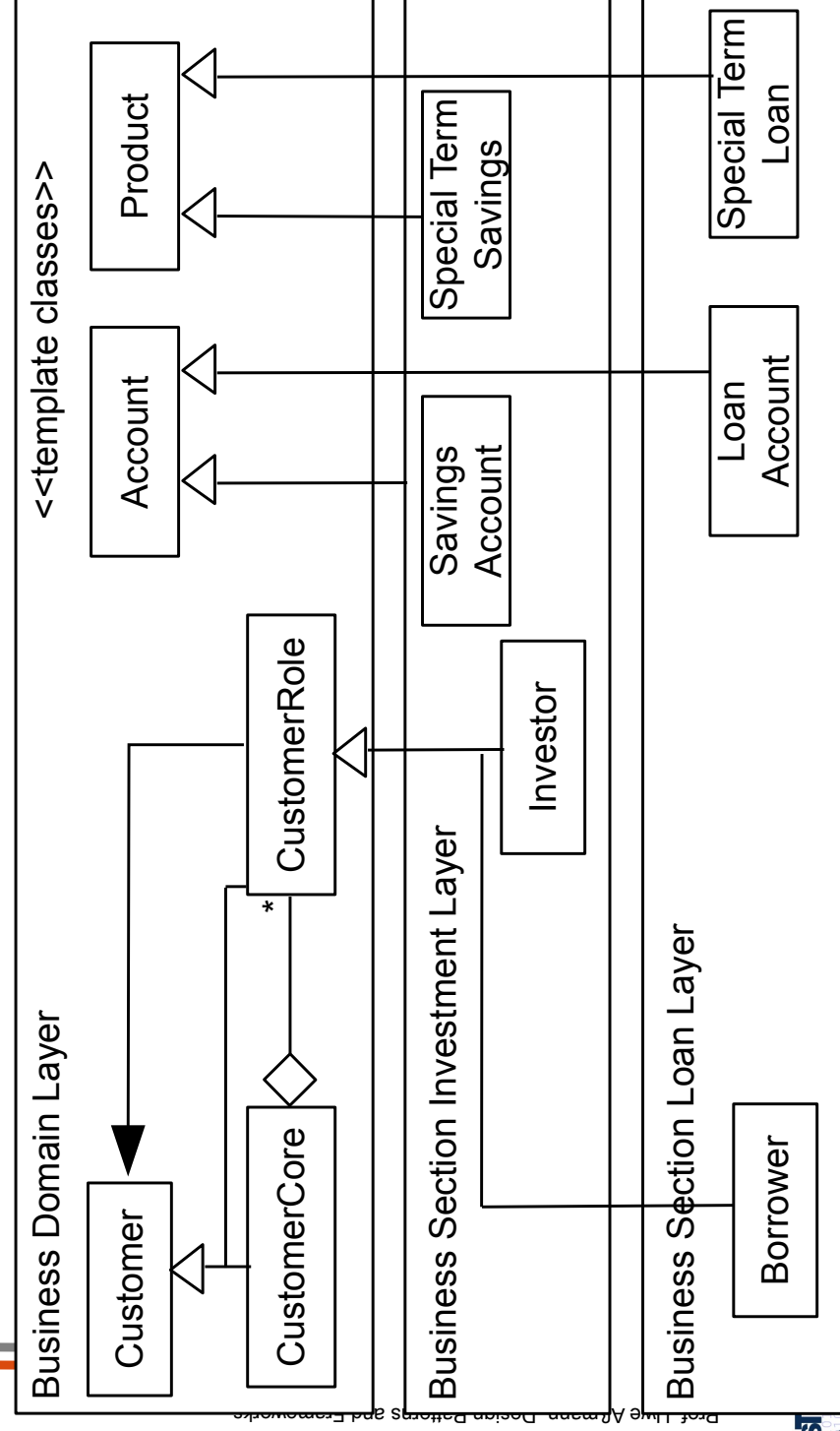

Role Object Pattern Vs Inheritance (White-Box Framework Layers)

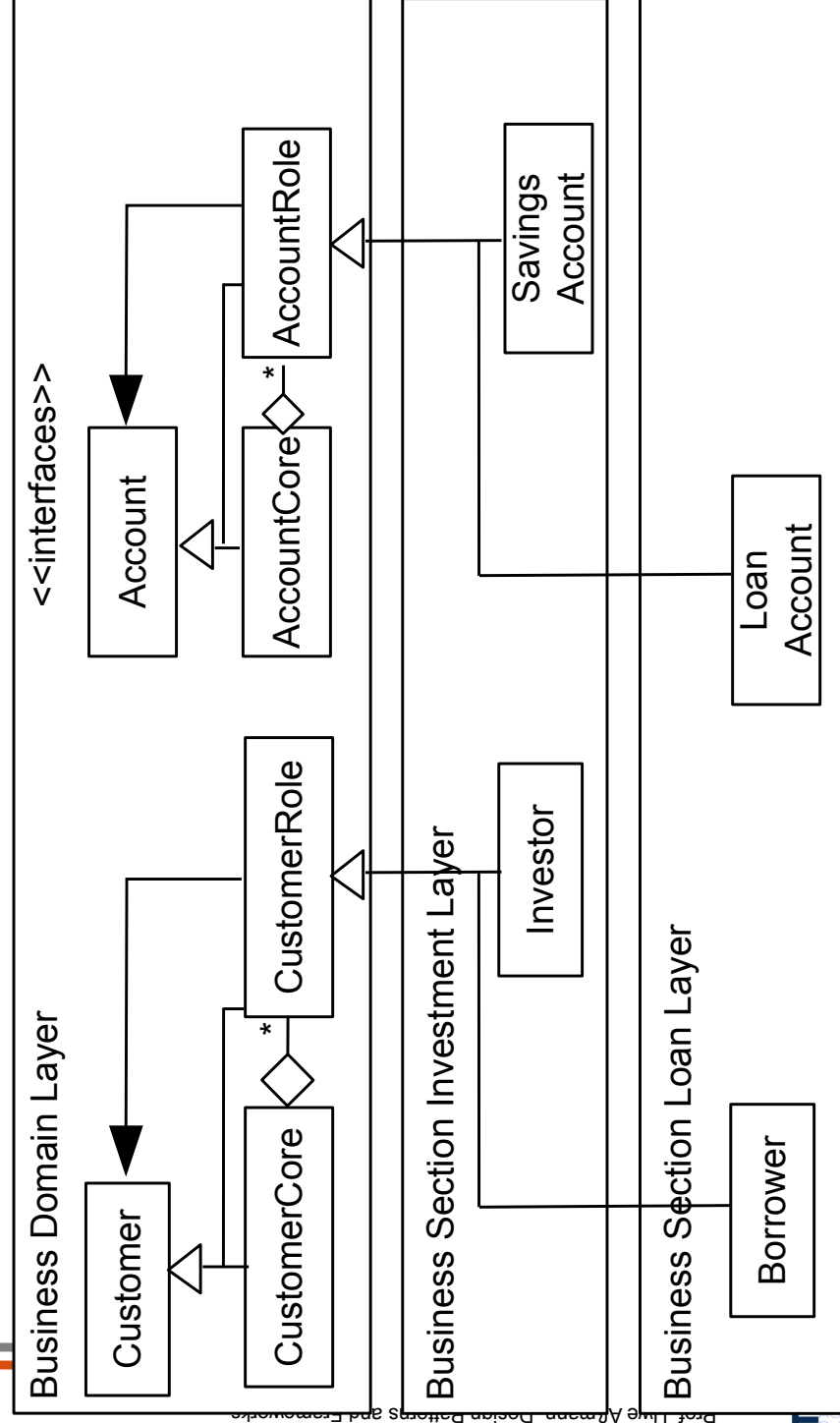

Comparison of Role Objects with Inheritance

- ▶ Simple inheritance has one instance of a subclass at a time
 - Subclass can change over time (polymorphism)
- ▶ The role object has many of them at the same time
 - All role objects can change (role polymorphism)
- ▶ Only changes in the base layers (technical, presentation, business) affect other layers
 - Changes in the business section layers do not affect the business domain layers
- ▶ The relation of core and role objects is a special form of part-of (combined with inheritance)

Role Object Pattern with Template and Hook Roles

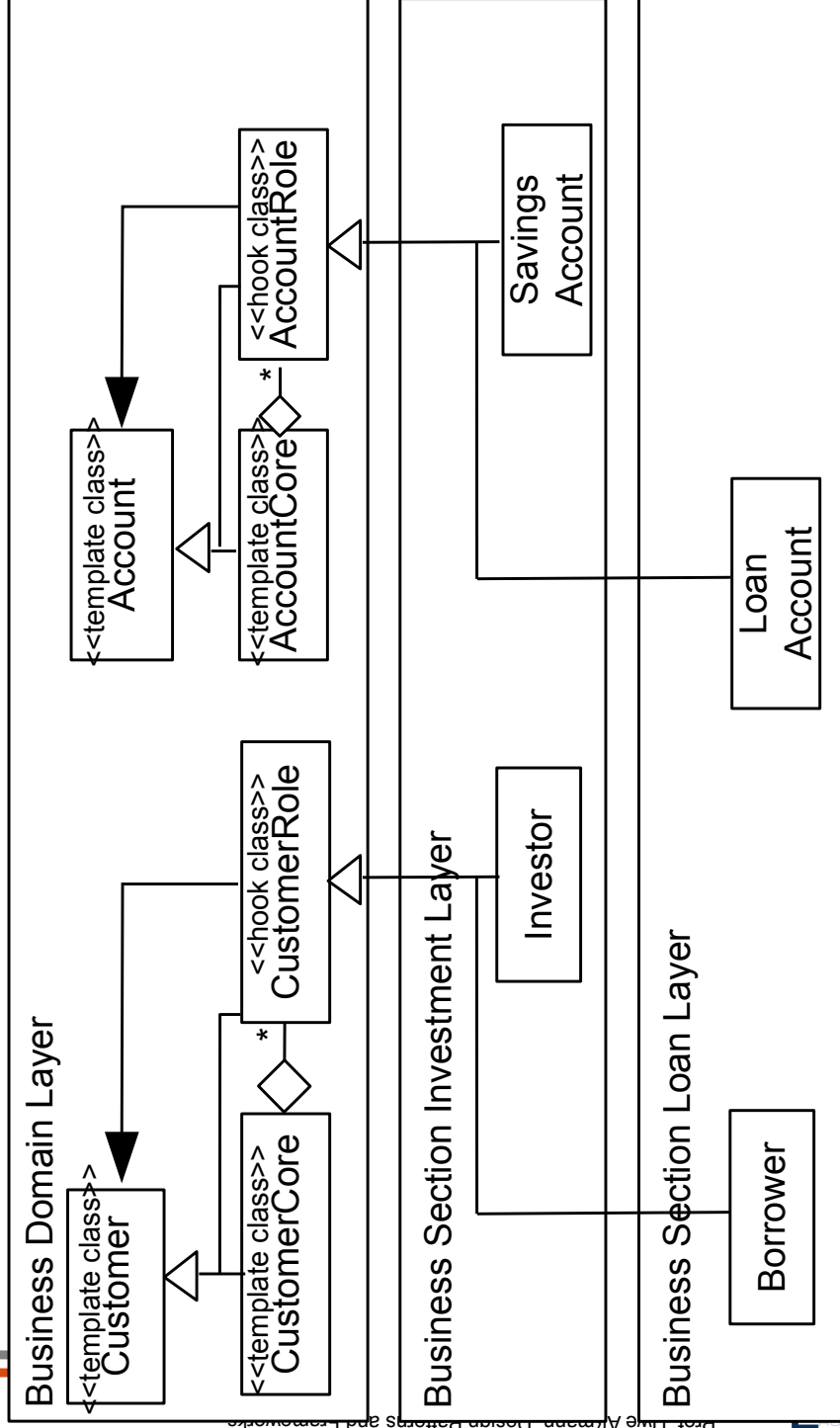

Riehle/Züllighovens Layer Pattern As Framework Hook Pattern

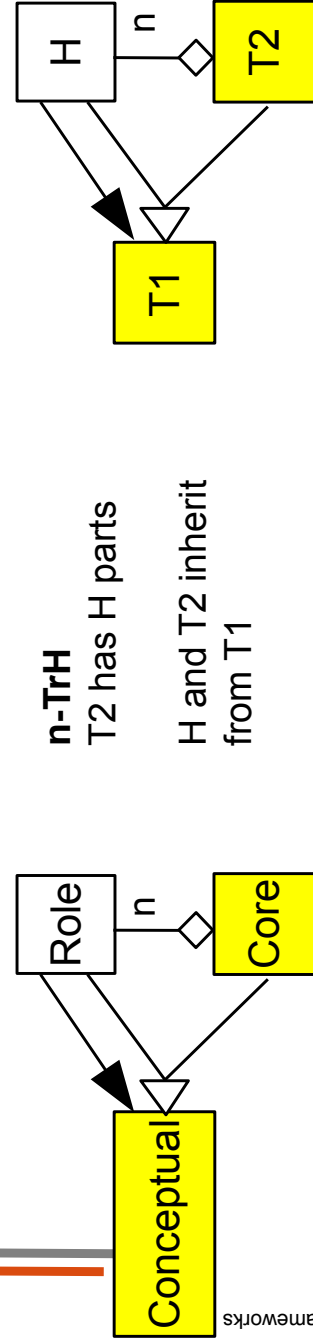

Core-Role-Pattern

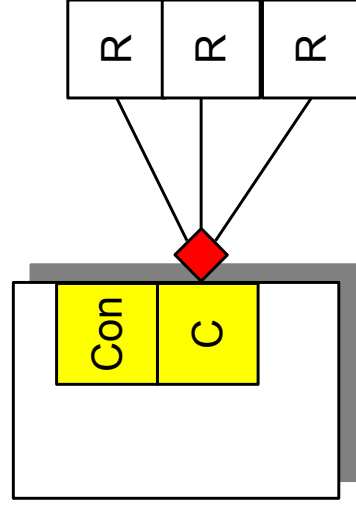

n-TrH mini-connector

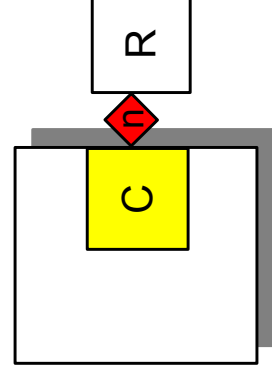

RoleObject Ensures Extensibility

- ▶ The RoleObject pattern lends itself not only to variability, but also to static and dynamic extensibility
 - If a framework hook is a role object pattern, the hook can be extended in unforeseen ways **without** changing the framework!
 - New layers of the application or the framework can be added at design time or runtime
- ▶ Powerful extension concept
 - Whenever you have to design something complex which should be extensible in unforeseen ways, consider Role Object

Riehle/Züllighovens Layered Role Object Framework

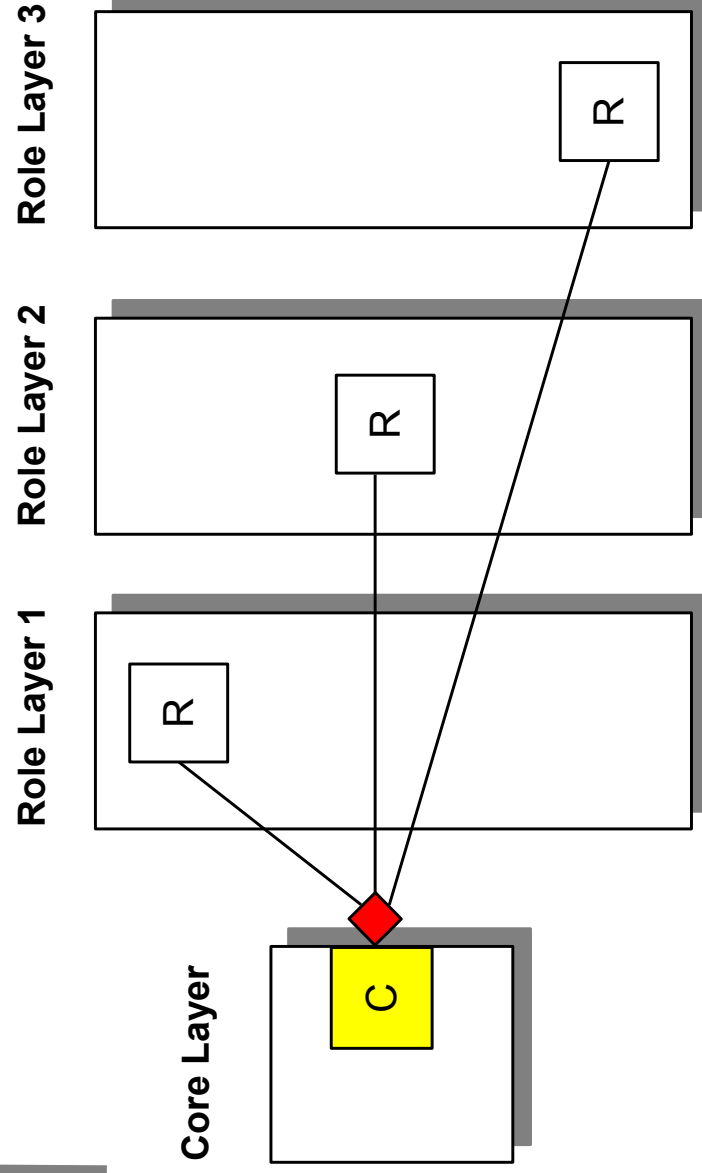

Extension in Layered Role Object Frameworks

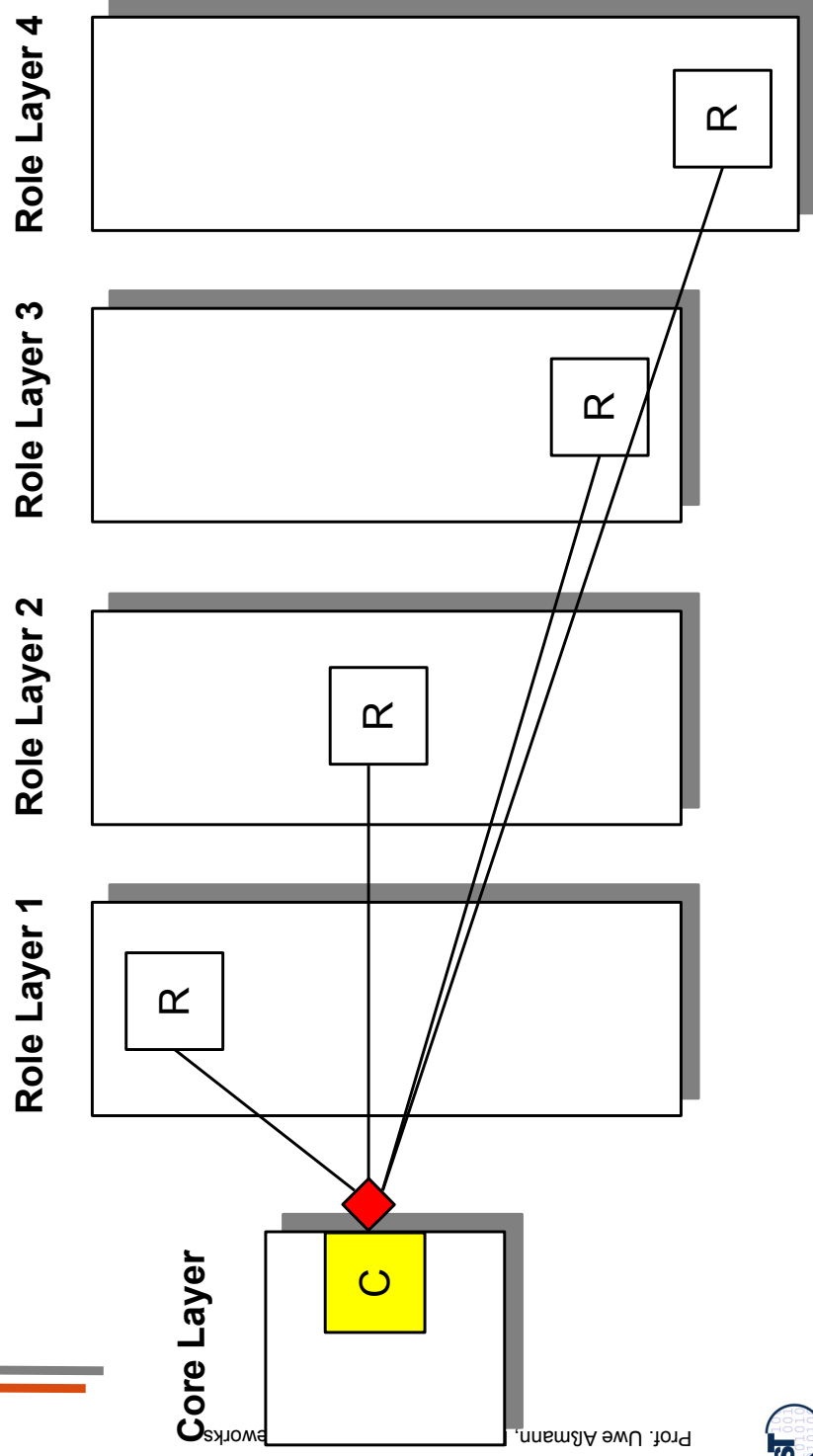

RoleObject Can Implement Dimensions That Are Not Independent

- ▶ The role objects implement dimensions
 - Core object implements primary dimension
 - Role object secondary dimension
- ▶ Role objects realize *one conceptual object*, instead of a role model crosscutting several conceptual objects
 - Facets are independent dimensions of a conceptual objects
 - Every dimension can be varied independently
- ▶ Comparison to the standard implementation of facets by Multi-Bridge (see Chapter “Simple Extensibility”)
 - Multi-Bridge has no inheritance between ConceptualObject, Core and Role
 - Multi-Bridge suffers from object schizophrenia, ROP can implement “this()” on itself without object schizophrenia
 - Calls to the role are not dispatched to the LogicalObject
 - Bridges must not inherit from each other, RoleObjects can

Benefit of Layered Role Objects Frameworks

- ▶ Implements conceptual objects with layered dependent dimensions
 - Not only independent dimensions
- ▶ Together with layering,
 - Easily extensible
 - Enormous variability
 - Simple structure for extensible product line architecture results
- ▶ For instance: **Layered Frameworks for Business Software**
 - Dispatch on all layers is necessary
 - Implementation without multimethods (in standard languages) *very hard*. Only CLOS, Cecil, and MultiJava are good here
 - That is one reason why business frameworks are so hard
 - SanFrancisco business framework of IBM didn't make it though a dynamic extensibility pattern
 - That's also why these applications are so expensive

The JWAM Framework

- ▶ Java WAM (Werkzeug Automat Material) is a layered framework for the Tools&Material pattern language www.jwam.de <http://sourceforge.net/projects/jwamtoolconstr/>
- ▶ The JWAM site has a lot of interesting papers, e.g., the PhD thesis of Bäumer

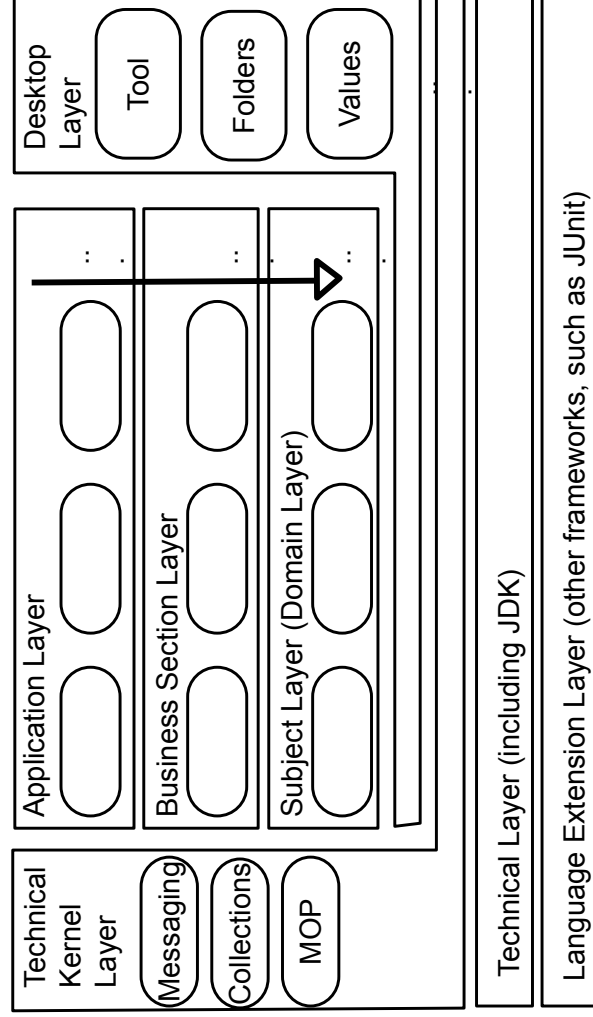

JWAM has a Kernel

- ▶ 100 classes and interfaces
- ▶ Simple applications can be built with the kernel only
- ▶ Extensions can be added, extension components:
 - Equipment components
 - Ready to use packages such as desktop, registry, form-service
 - Integration components
 - Database connection...

12.4 The GenVoca Pattern, Mixin Layers, and Layered Mixin Frameworks



The Mixin Concept

- ▶ A Mixin is a partial class, for an extension of another class
- ▶ Some languages have mixins (Scala, C#, Eiffel)
- ▶ Otherwise, mixins can be expressed as class fragments that can be parameterized with a superclass
- ▶ Mixins can implement (static) roles and facets

```
template <class S>
class EmployeeMixin extends S {
  // class extension..
  Salary salary;
  Employer emp;
}
```

```
EmployeeMixin<Person> employeeOfPerson;
EmployeeMixin<German> employeeOfGerman;
EmployeeMixin<Club> employeeOfClub;
```

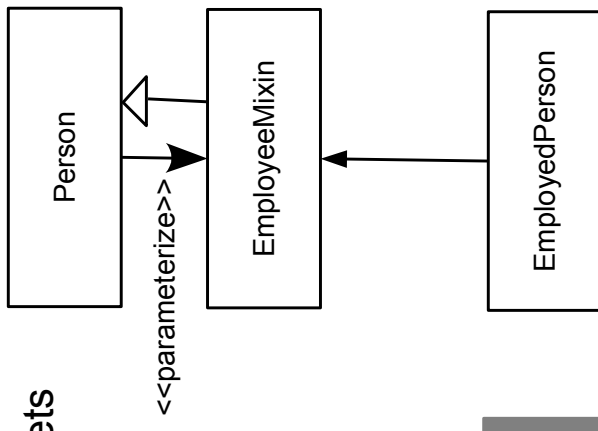

43

The GenVoca Pattern

- ▶ If several mixin parameterizations are nested, the GenVoca pattern results [Batory]

```
template <class S> class EmployeeMixin extends S {
  Salary salary;
  Employer emp;
}

template <class S> class ParentMixin extends S {
  Child child;
  Money kindergeld;
}

template <class S> class HobbyMixin extends S {
  Hobby hobby;
}

// Persons composed with GenVoca pattern
HobbyMixin<ParentMixin<EmployeeMixin<Person>>> assmann;
EmployeeMixin<ParentMixin<HobbyMixin<Person>>> assmann2;
// Have assmann and assmann2 the same type?
```

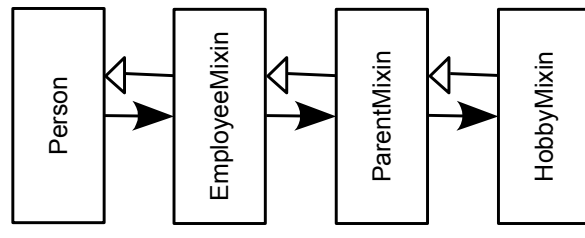

44

GenVoca Variations

- ▶ When different variants exist for a “abstraction layer”, parameterizations express configurations of a product line

```
// Variants
Person: Man, Woman
ParentMixin: FatherMixin, MotherMixin
EmployeeMixin: TimedEmployee, PermanentEmployee
HobbyMixin: PigeonFriend, Sportsman, GolfPlayer

// Compositions
GolfPlayer<TimedEmployee<Father<Man>>>> assmann;
PigeonFriend<PermanentEmployee<Father<Man>>>> miller;
GolfPlayer<PermanentEmployee<Mother<Woman>>>> brown;
```

Variations on Different Abstraction Layers form Product Variants

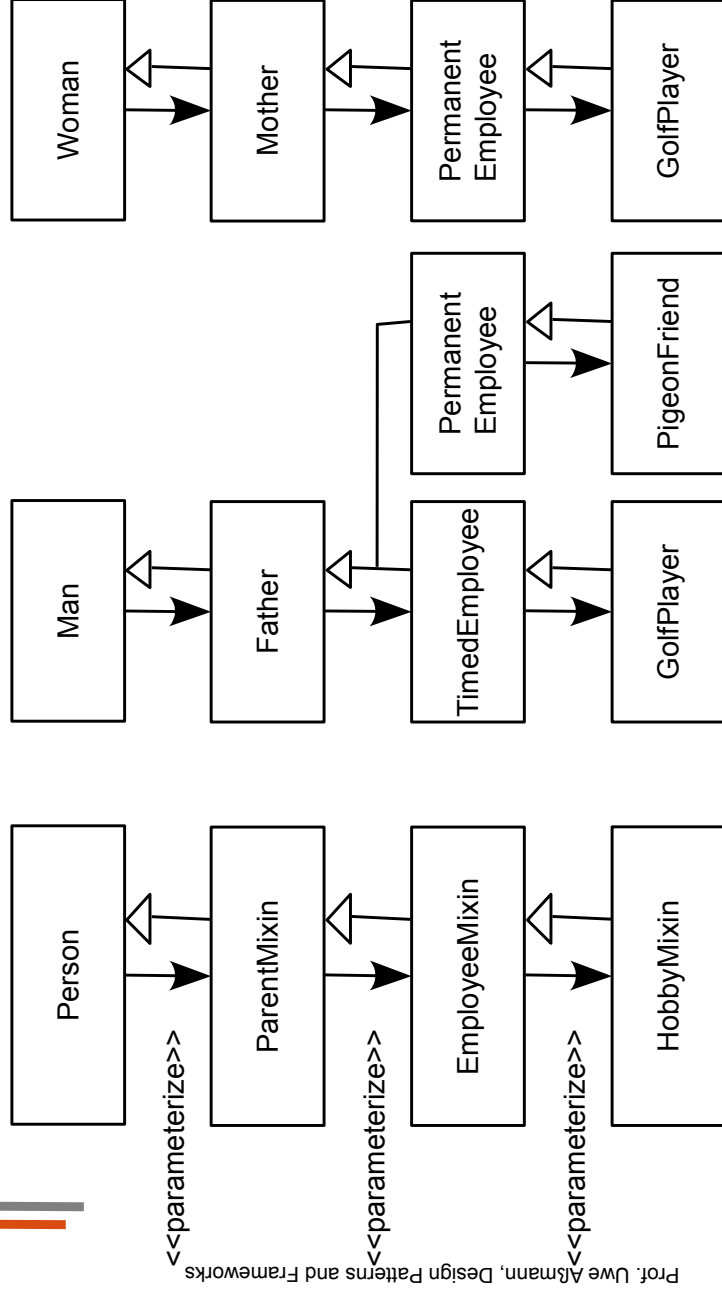

Variations on Different Role Layers

- ▶ Abstraction layers correspond to *role layers* of complex objects
- ▶ Roles *collaborate*, but are not implemented by role objects, but by mixins

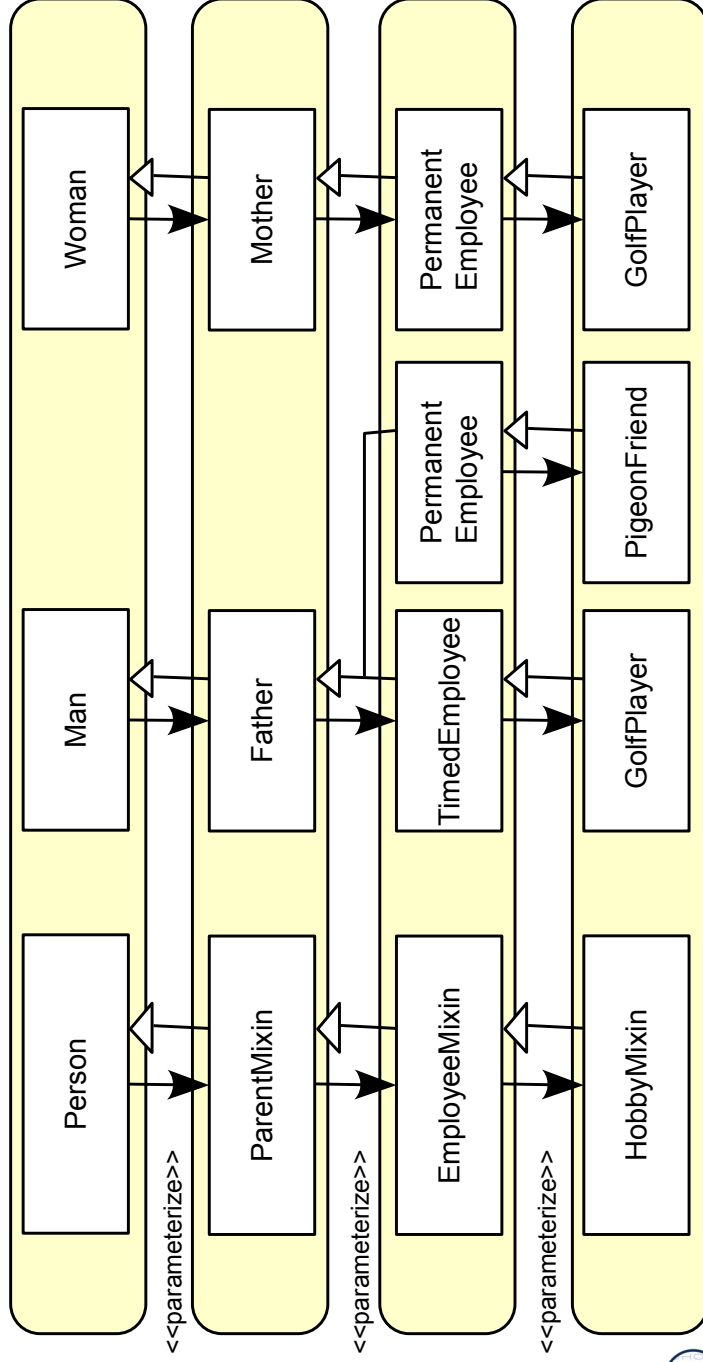

Discussion

- ▶ A *mixin layer* groups all mixins of a role abstraction layer
- ▶ Mixins play in the GenVoca pattern the same role as role objects in the role object pattern and layered role frameworks
 - However, all role objects are *embedded* into one physical object
 - There is a physical identity for the entire logical object
 - No object schizophrenia to be avoided
 - GenVoca applications are more efficient, since they merge all roles together into one physical object (see the Alßmann's law on role merging)
- ▶ Similarly to layered role object frameworks, layered GenVoca frameworks can model big product lines
 - Every abstraction layer (mixin layer) expresses variability
 - New mixin layers model extensibility

12.5 The Mixin Layer Pattern

- ▶ While the GenVoca pattern deals with single stacking of parameterizations, the MixinLayer pattern groups all roles of an abstraction layer together and composes entire layers
- ▶ MixinLayer treats all logical objects of an application

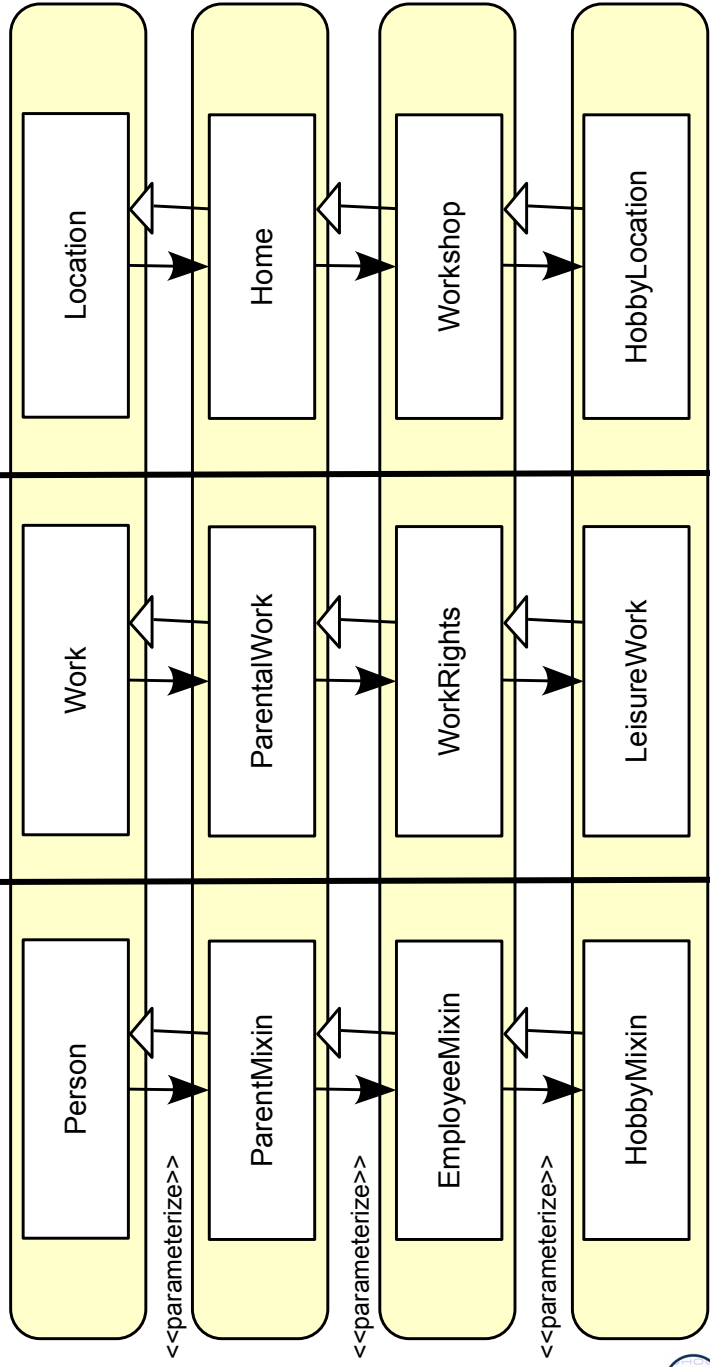

Mixin Layers as Compositional Unit

- ▶ A mixin layer gets a name and can be exchanged consistently for a variant, changing the behavior of the entire layer

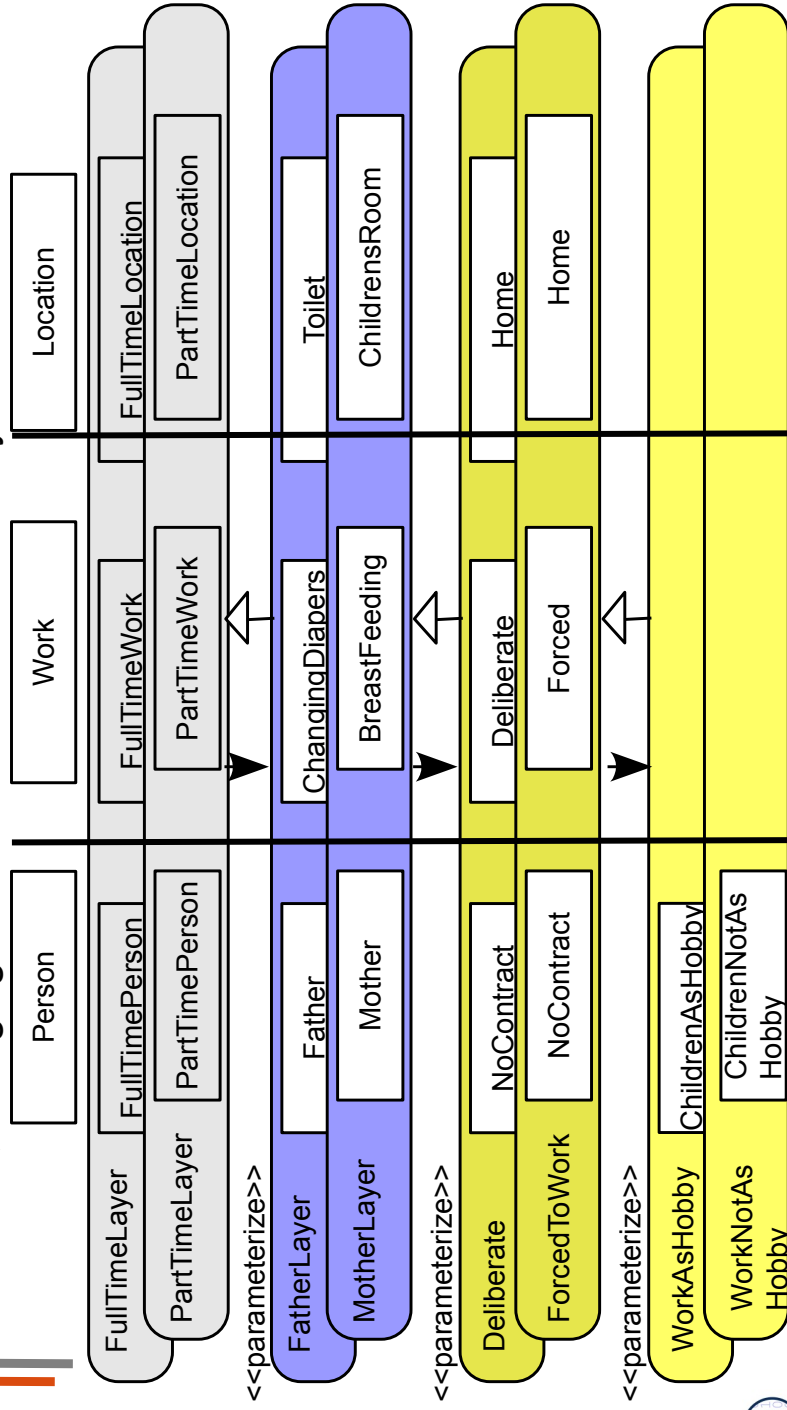

Composition of Mixin Layers

- ▶ Mixin layers are composed similarly to single GenVoca mixins
 - Meaning: All role classes are consistently exchanged with their layer

```
CoreLayer: FullTime, PartTime
ParentLayer: FatherLayer, MotherLayer
EmployeeLayer: Deliberate, ...
HobbyLayer: WorkAsHobby, Slave....

// This is now mixin layer composition!
WorkAsHobby<Deliberate<FatherLayer<FullTime>>>> assmann;
```

Implementation of Mixin Layers with GenVoca Pattern and Inner Classes

- ▶ The role classes of upper layers form super classes of the layer class
- ▶ The following pattern allows for separate parameterization of all role mixins, *not* the layer as a whole

```
class Layer <class Super, class RoleSuper1, ..., class RoleSupern>
  extends Super {
  class Role1 extends RoleSuper1 { .. }
  ..
  class Rolen extends RoleSupern { .. }
  .. additional classes..
}
```

Implementation of Mixin Layers with Designated Inner Classes

- ▶ If the target language permits to have inner classes that can be designated by an expression, mixin layers can be inherited as a whole
- ▶ The super mixin layer can be selected by one single expression $L < L1 >$

```
class Layer <class Super>
// The class Super has n inner role classes RoleSuper1, ...,
// RoleSupern
extends Super {
class Role1 extends Super.RoleSuper1 { .. }
..
class Rolen extends Super.RoleSupern { .. }
.. additional classes..
}
```

Example: A Graph Framework

- ▶ Graph applications can be structured into mixin layers
- ▶ $\text{ConnectedOnDFTUndirected} = \text{CRL1} < \text{CL1} < \text{VN1} < \text{TL1} < \text{RL1} > > > >$
- ▶ $\text{ConnectedOnBFTRevDirected} = \text{CRL1} < \text{CL1} < \text{VN2} < \text{TL2} < \text{RL2} > > > >$

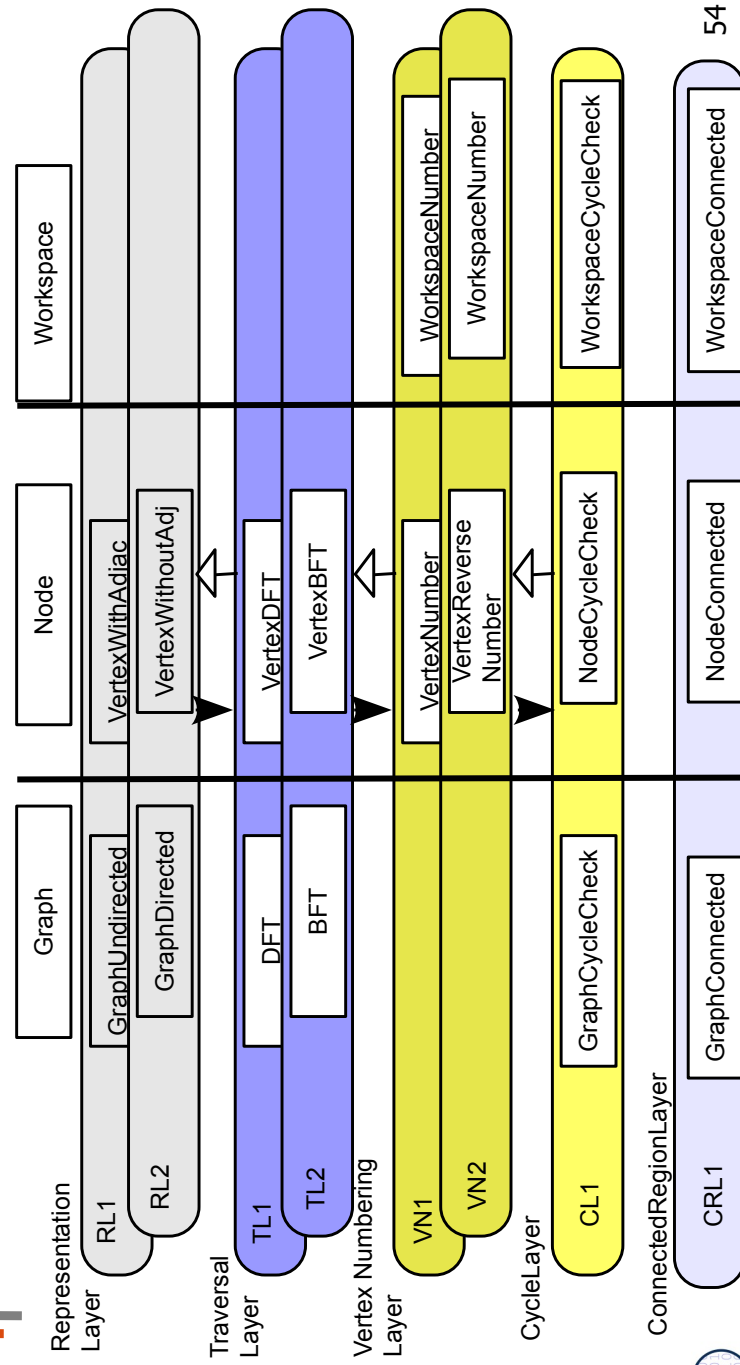

Layered Mixin Frameworks vs Layered Role Object Frameworks

- ▶ Every mixin layer corresponds to a role layer
- ▶ Mixin layers form *frameworks* that can be extended by mixin layer composition towards applications
- ▶ Same variability effects for big product lines

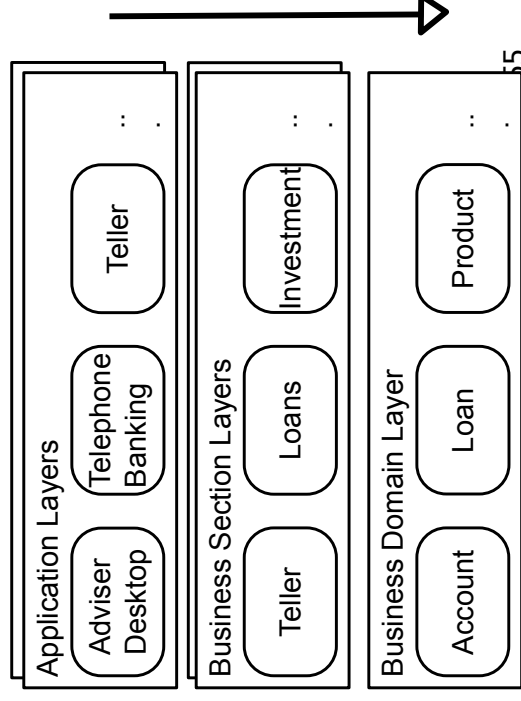
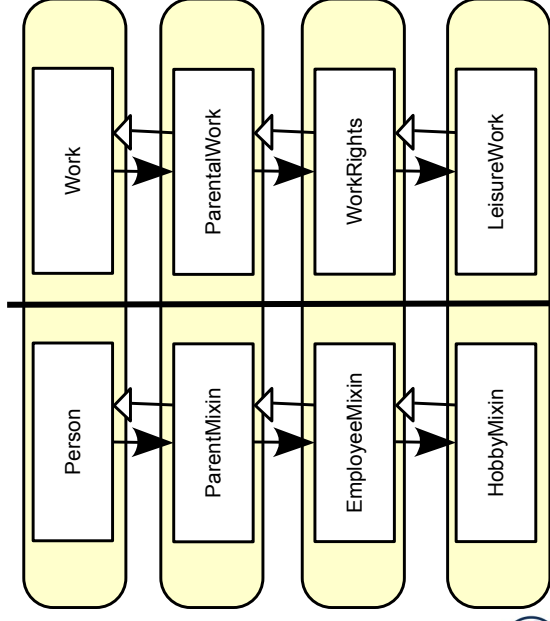

Layered Mixin Frameworks vs Layered Role Object Frameworks

- ▶ Unfortunately, the direction of generality is usually drawn in the opposite way in mixin layer frameworks and role object frameworks
- ▶ If we agree to put the “most general abstraction layer” downmost, the dependencies go into the same direction
- ▶ Features on the upper layers *depend* on the lower layers

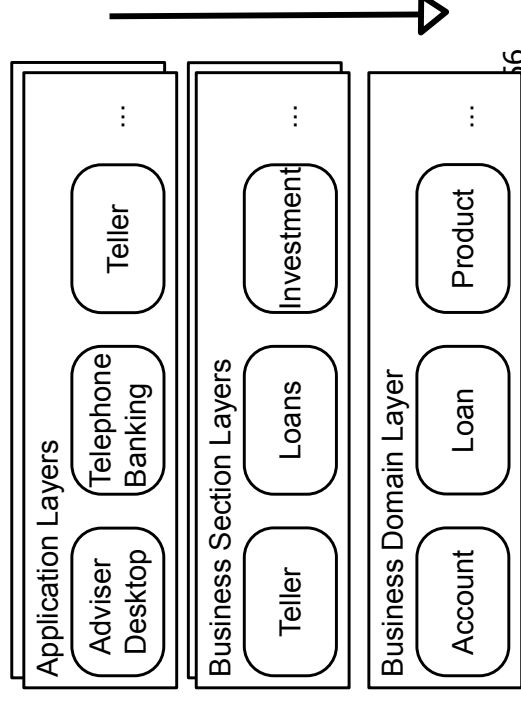
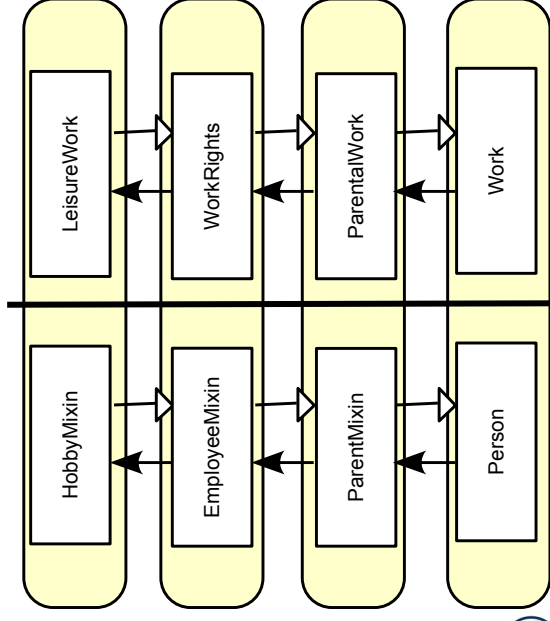

Layered Mixin Frameworks vs Layered Role Object Frameworks

- ▶ Essentially, layered role object frameworks and layered mixin frameworks provide the same concept for variability and extensibility
- ▶ Difference: mini-connector
 - Layered role object frameworks use as mini-connector the Role Object Pattern
 - Layered mxin frameworks use as mini-connector the GenVoca pattern



12.6 How To Find Concerns for a Layered Framework

Example: Layered Frameworks for the Semantic Web

A New Application Area: Semantic Web Applications

- ▶ Semantic web:
 - Standardization technology for the Web and many application domains
 - Definition of *ontologies*, standard dictionaries
 - Based on inheritance and constraints
- ▶ Every application domain will have its “Semantic Web ontology”
- ▶ How to build product families for those domains?

The Concerns of an Application in the Semantic Web

- ▶ Which concerns exist?
- ▶ After a little thought: three groups of concerns. (This is not complete, there might be more)

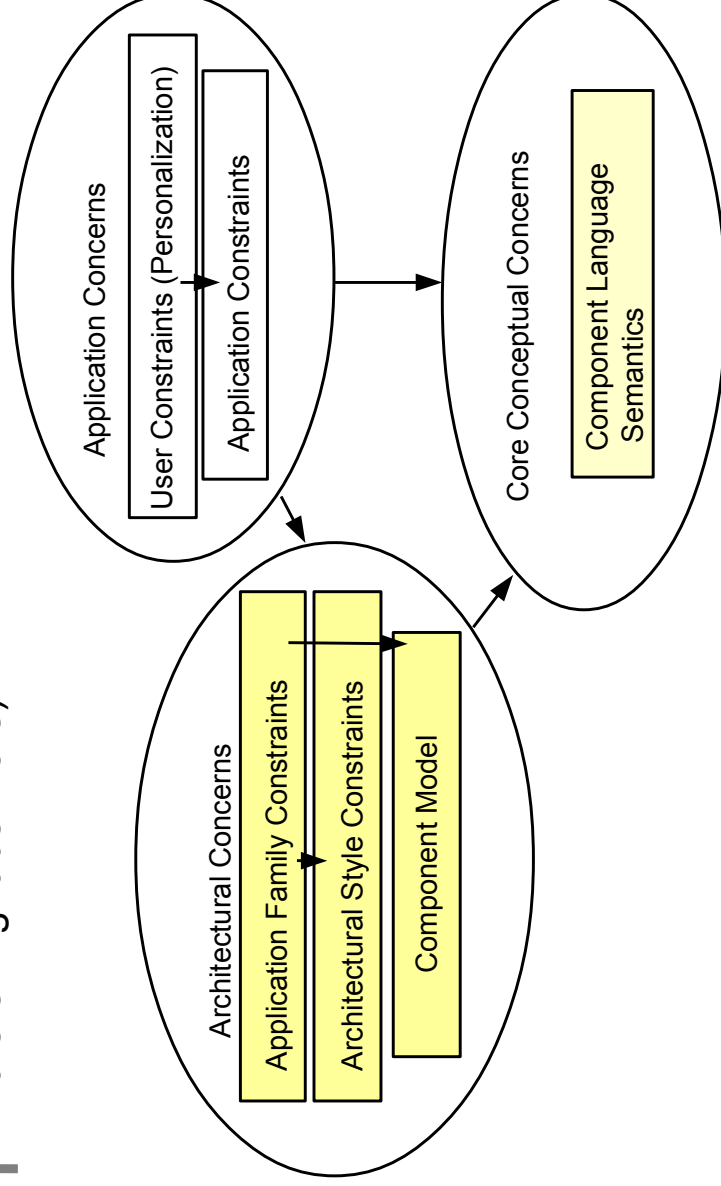

Layered Frameworks for Product Lines on the Semantic Web

- ▶ We can sort the acyclically dependent concerns into a layered architecture, in which several ComplexObjects crosscut all layers
 - On every level, there are constraints to check the layer for consistency
 - All role objects on the layer are checked by the constraints

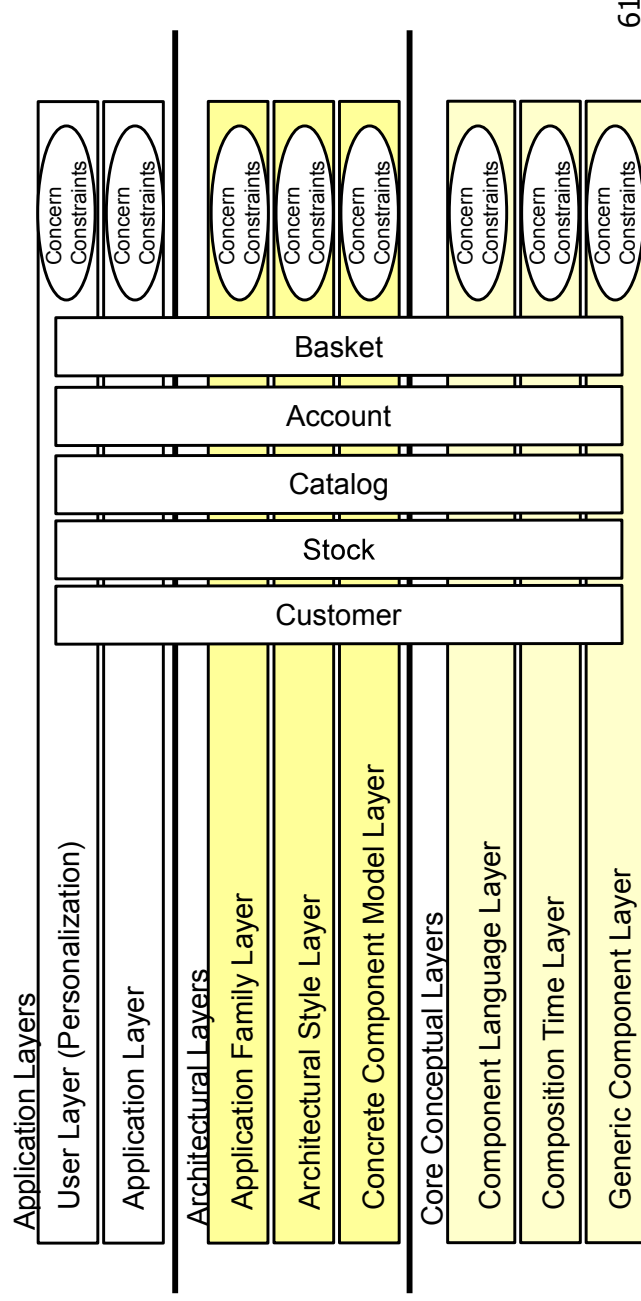

Layered Frameworks for Composition Systems

- ▶ Even a composition system for web applications can be arranged in role layers

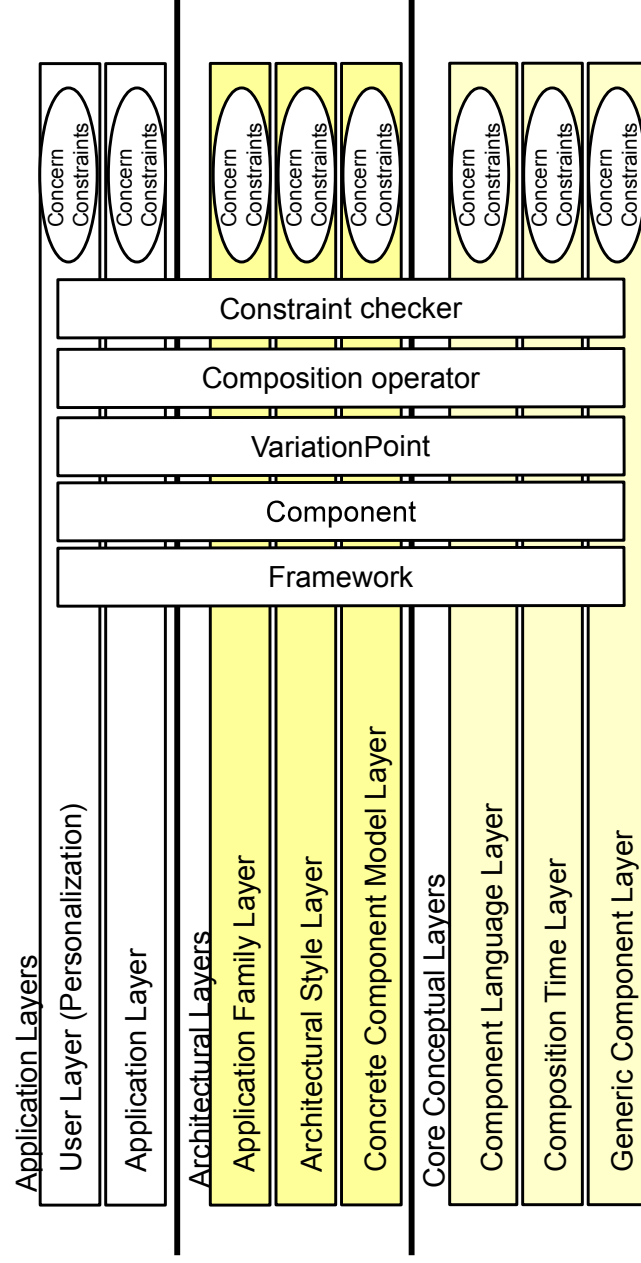

Layers can be Instantiated Differently

- ▶ On every layer of the layered framework, there is variation and extensibility
- ▶ New user constraints
- ▶ New application constraints
- ▶ New application family constraints
- ▶ New architectural constraints
- ▶ New component models
- ▶ New component languages
- ▶ Different Languages in One Framework
 - Since the language is a layer, it can be exchanged
 - Several ontology languages can be used for components in Semantic Web applications
 - BPEL, Datalog, Prolog, OWL

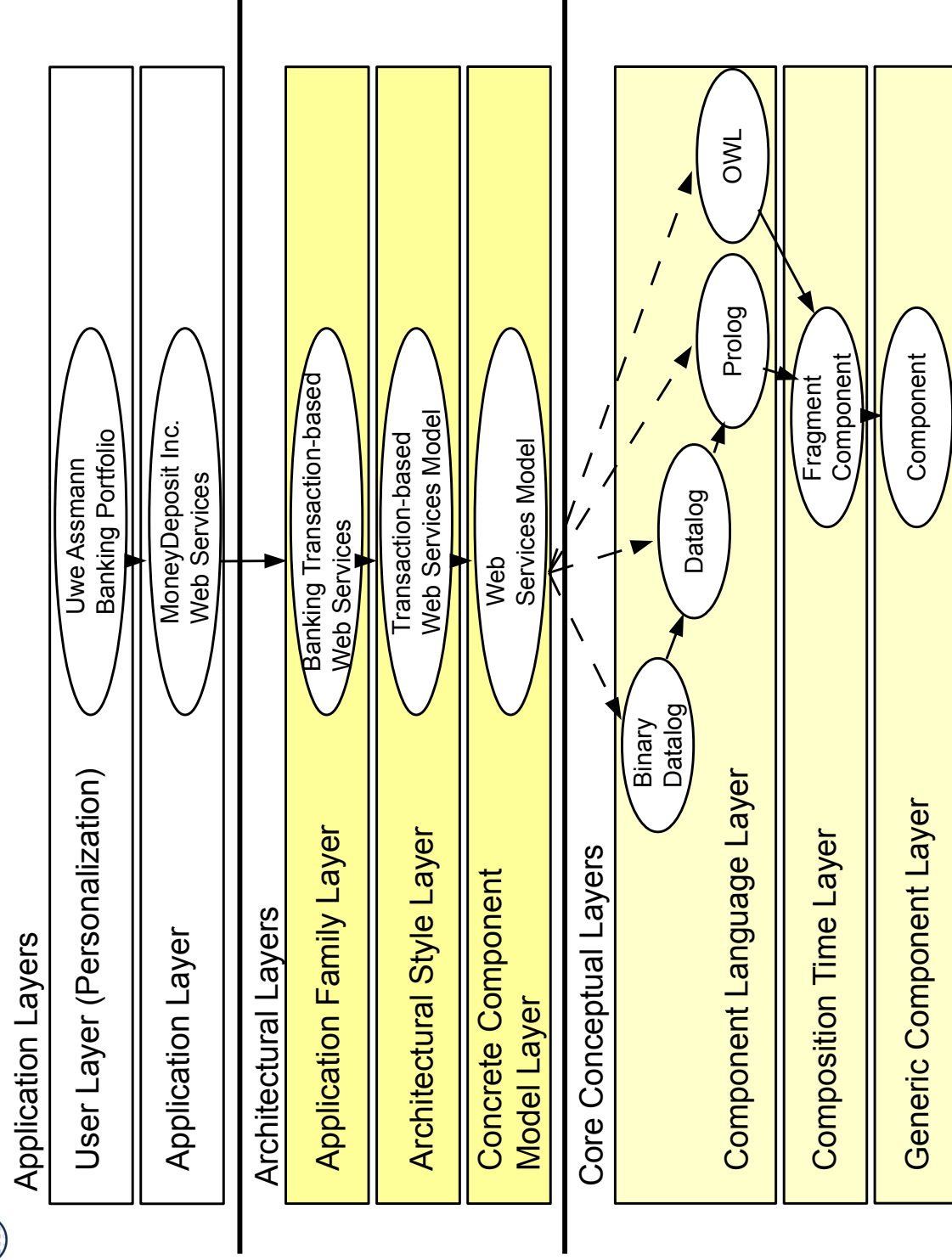

Different Architectures are Possible for One Component Model

- ▶ Since the architectural styles can be exchanged for the same component model

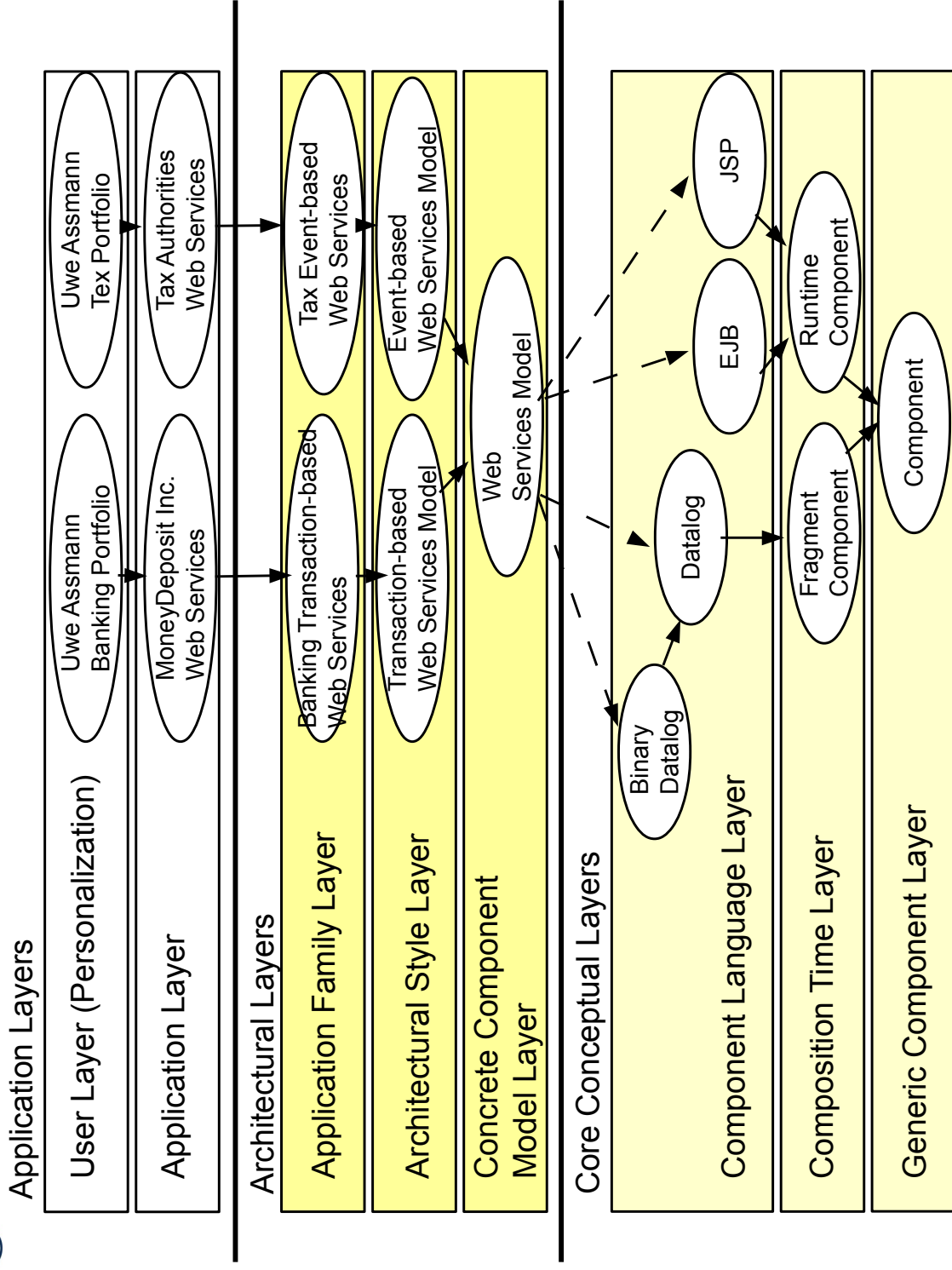

Different Component Models Can Coexist

- ▶ Interoperability of Semantic Web application is simplified

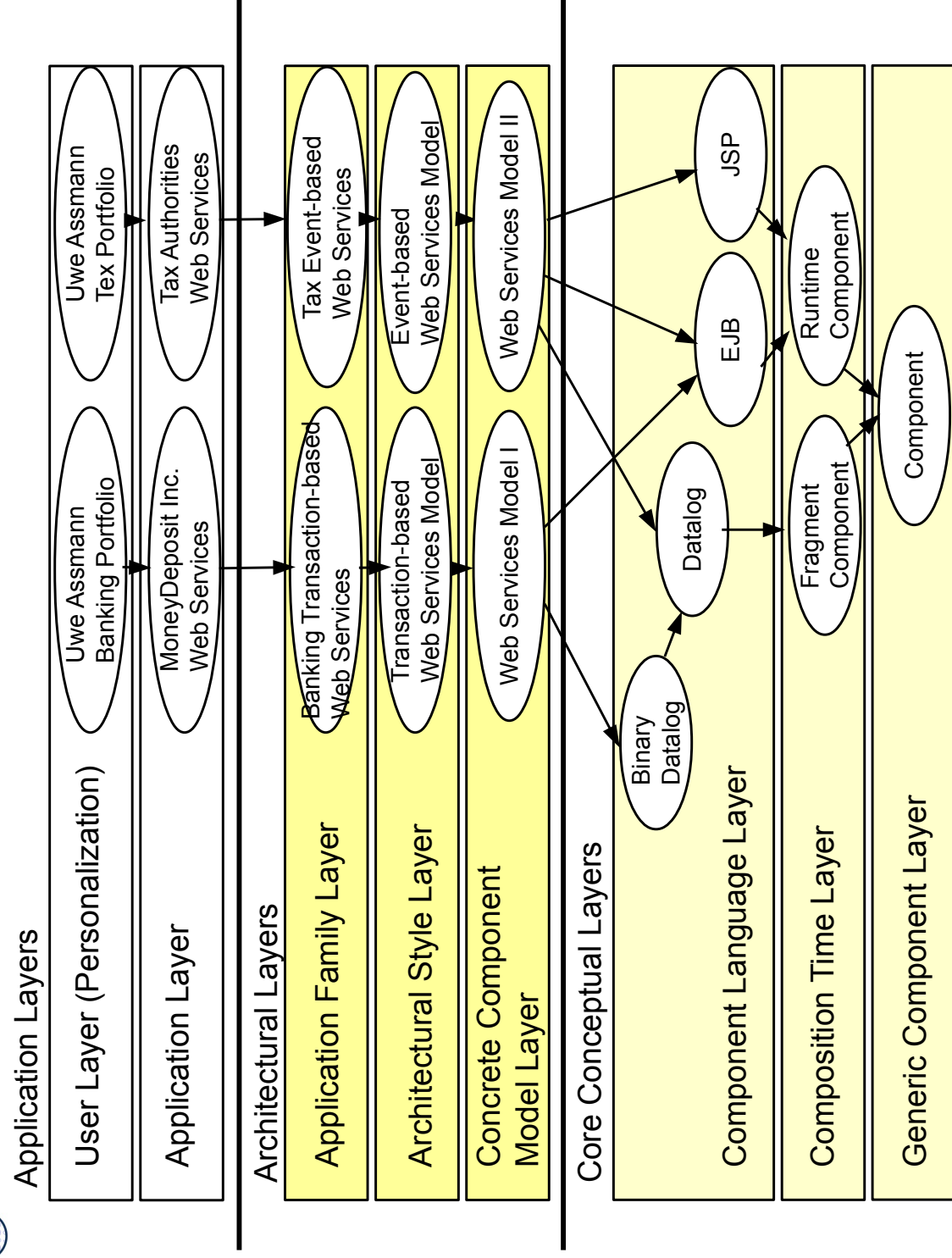

Layered Frameworks and Component Models

- ▶ Once, if languages and component models are layers, layered frameworks can be generalized considerably.
 - Implementation with Layered ROP frameworks or Layered mixin frameworks
- ▶ It becomes possible to build totally heterogeneous applications:
 - Different framework and component languages
 - Different architectures and architectural styles
 - Different product lines (application families)

What Have We Learned?

- ▶ How can we structure a Product Line as Layered Framework?
 - ExtensionObjects is a simple extension mechanism for frameworks
 - Layered frameworks provide variability and extensibility for thousands of different products in a product line
- ▶ Process for layered frameworks:
 - Identify concerns (abstraction layers), which crosscut all or many objects. These concerns are similar to facets, but not independent
 - Sort them according to their (acyclic) dependencies
 - Use ROP or Genvoca pattern for implementation
 - Use framework role layers or mixin layers for a layered application

The End

