

2. Simple Patterns for Variability

1

- Prof. Dr. U. Aßmann
Chair for Software Engineering
Faculty of Informatics
Dresden University of
Technology
WS 13-0.1, 11/16/13
- 1) Basic Template-And-Hook Patterns
 - 2) Faceted Objects with Bridges
 - 3) Layered Objects
 - 4) Dimensional Systems
 - 5) Layered Systems



Design Patterns and Frameworks, © Prof. Uwe Aßmann

Literature (To Be Read)

2

- ▶ V. Caisin. Creational Patterns. Paper in Design Pattern seminar, IDA, 2001. Available at home page.
- ▶ GOF, Chapters on Creational and Structural Patterns
- ▶ Another good book:
- ▶ Head First Design Patterns. Eric Freeman & Elisabeth Freeman, mit Kathy Sierra & Bert Bates. O'Reilly, 2004, ISBN 978-0-596-00712-6
- ▶ German Translation: Entwurfsmuster von Kopf bis Fuß. Eric Freeman & Elisabeth Freeman, mit Kathy Sierra & Bert Bates. O'Reilly, 2005, ISBN 978-3-89721-421-7



Secondary Literature

- ▶ D. Karlsson: Metapatterns. Seminar Design Patterns, IDA, Linköpings universitet, 2001.
- ▶ W. Pree. Design Patterns for Object-Oriented Software Development. Addison-Wesley, 1995. Unfortunately out of print.
- ▶ W. Zimmer. Relationships Between Design Patterns. Pattern Languages of Programming (PLOP) 1995.
- ▶ Uta Priss. Faceted Information Representation. Electronic Transactions in Artificial Intelligence (ETAI). 2000(4):21-33.
- ▶ R. Prieto-Diaz, P. Freeman. Classifying Software for Reusability. IEEE Software, Jan 1987. Prieto-Diaz has introduced facet-based classifications in software engineering. Surf also on cite-seer for facets.

Goal

- ▶ Understanding Templates and Hooks
 - Template Method vs Template Class
 - Dimensional Class Hierarchy
- ▶ Understanding why Bridges implement faceted objects
- ▶ Understanding layered systems

2.1) Basic Template and Hook Patterns

5



Design Patterns and Frameworks, © Prof. Uwe Aßmann

The Problem

- ▶ How to produce several products from one code base?
- ▶ Design patterns often center around
 - Things that are common to several applications
 - *Commonalities* lead to *frameworks* or *product lines*
 - Things that are different from application to application
 - *Variabilities* to *products* of a product line

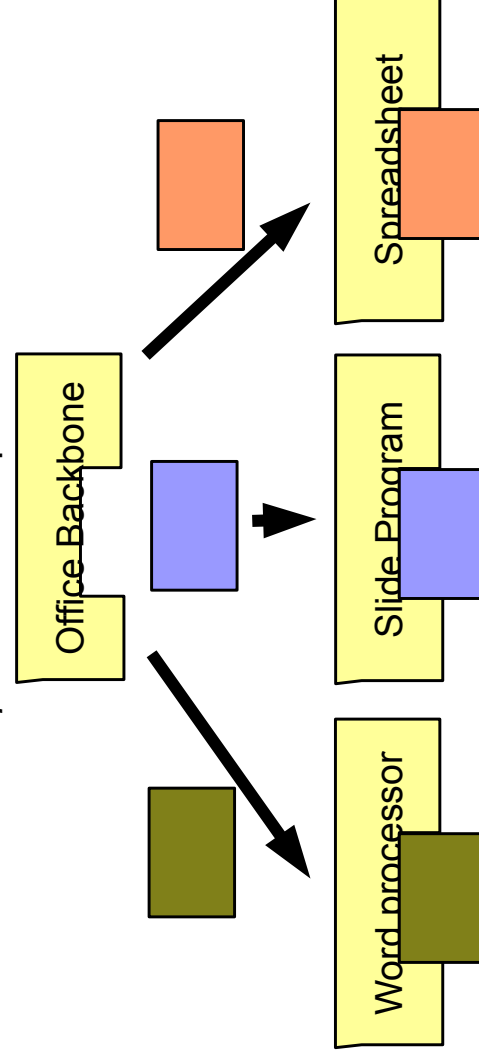

Pre's Template&Hook Conceptual Pattern

7 ▶ Pre invented a (*template-and-hook T&H*) concept for the communality/variability knowledge in design patterns [Pre] [Karlsson]

- ▶ *Templates contain skeleton code*
 - Common for the entire product line
- ▶ *Hooks are placeholders for the instance-specific code*
 - Only for one product. Also called *slots*, *hotspots*

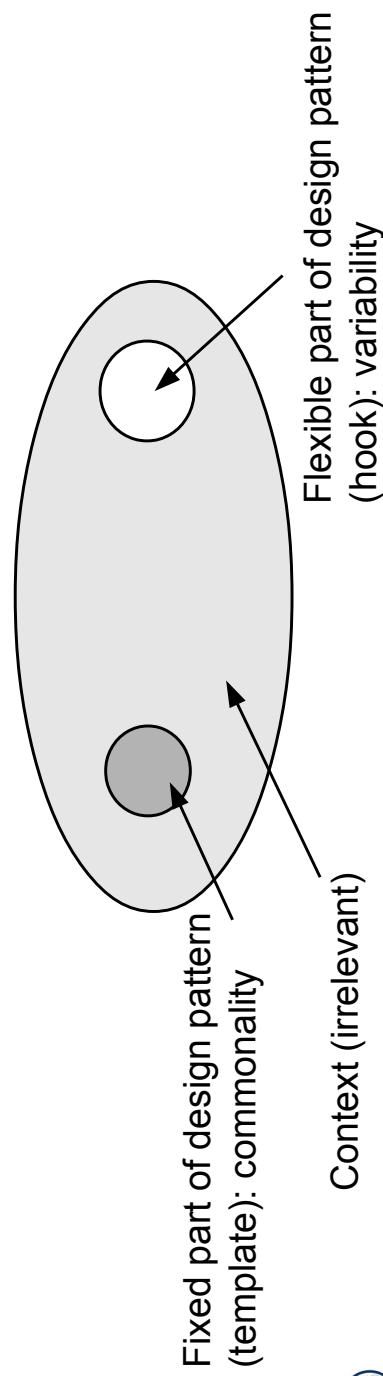

Design Pattern TemplateMethod

- 8
- ▶ Define the skeleton of an algorithm (*template method*)
 - The template method is concrete
 - ▶ Delegate parts to abstract *hook methods (slot methods)* that are filled by subclasses
 - Requires inheritance
 - ▶ Implements template and hook with the same class, but different methods

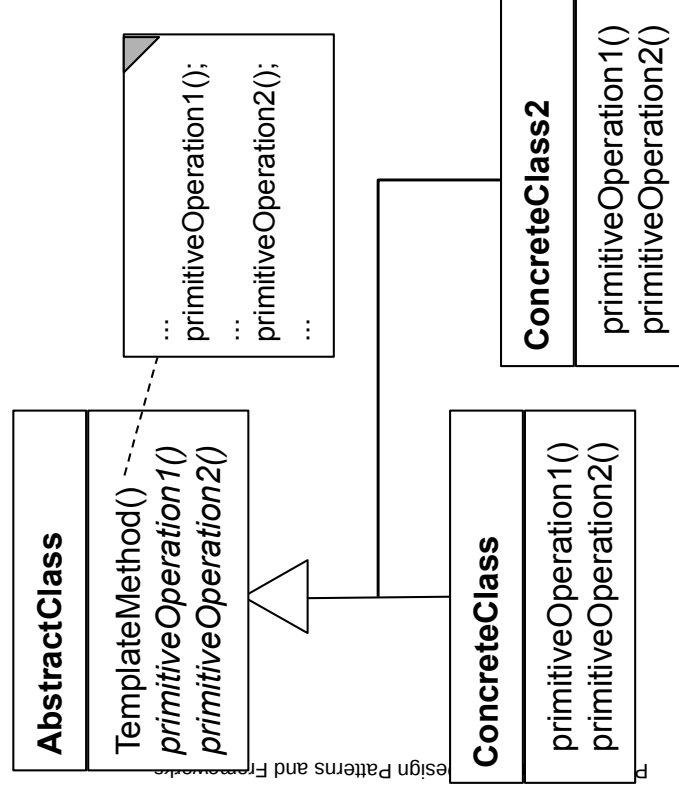

Ex.: Actors and Genres

- ▶ Binding an Actor's hook to be a ShakespeareActor or a TV actor

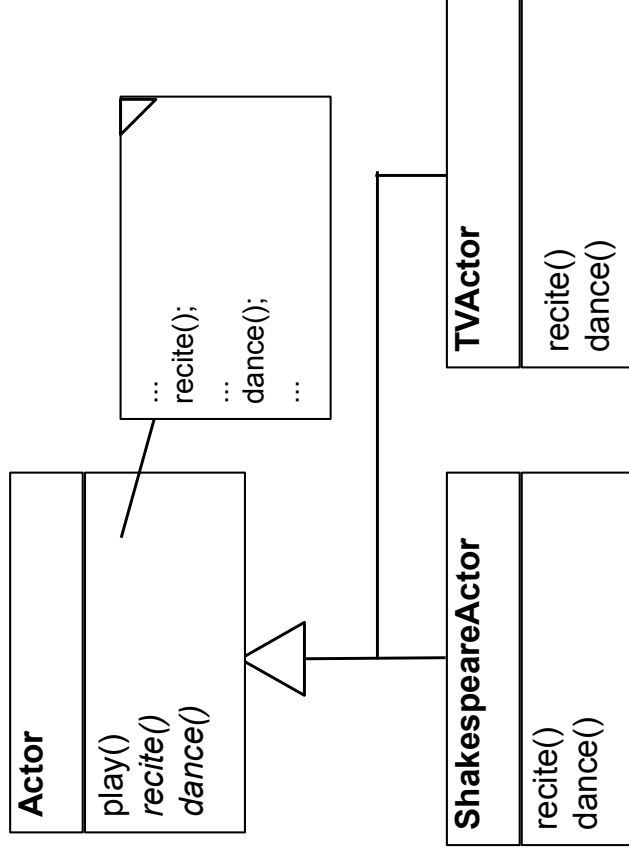

9



Variability with TemplateMethod

- ▶ Allows for varying behavior
 - Separate invariant from variant parts of an algorithm
 - TemplateMethod differs slightly from polymorphism: for a polymorphic method, one needs several subclasses
- ▶ Binding the hook (slot) means to derive a concrete subclass from the abstract superclass, providing the implementation of the hook method

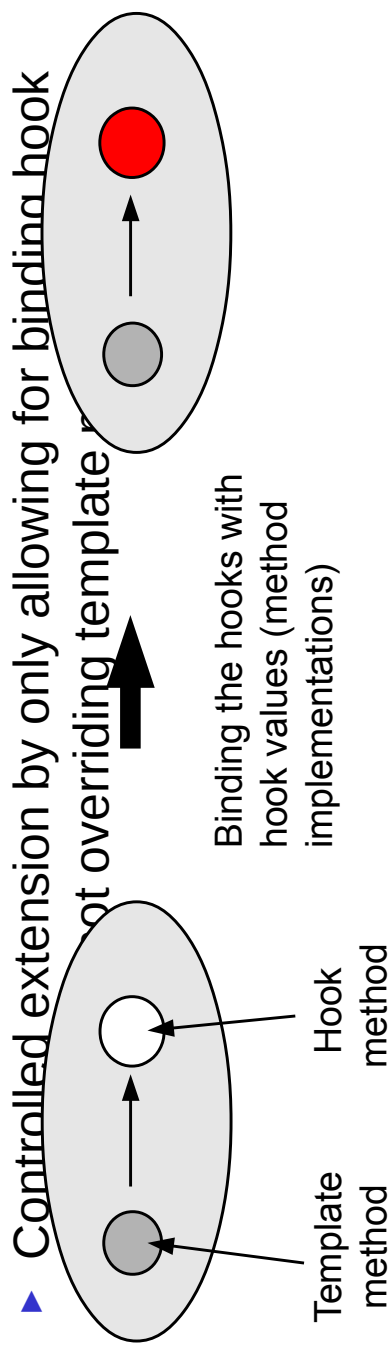

10



Consequences

- ▶ The design pattern TemplateMethod realizes the conceptual pattern T&H on the level of Methods
 - TemplateMethod – HookMethod
- ▶ Basis for design patterns:
 - FactoryMethod
 - TemplateClass

11

Variability vs Extension

- ▶ The T&H concept occurs in two basic variants
 - Binding of hooks or extension of hooks: we speak of a *slot*, if a hook can be bound only once (unextensible hook, only bindable)
 - Hooks can be extensible
- ▶ Design patterns are treated later

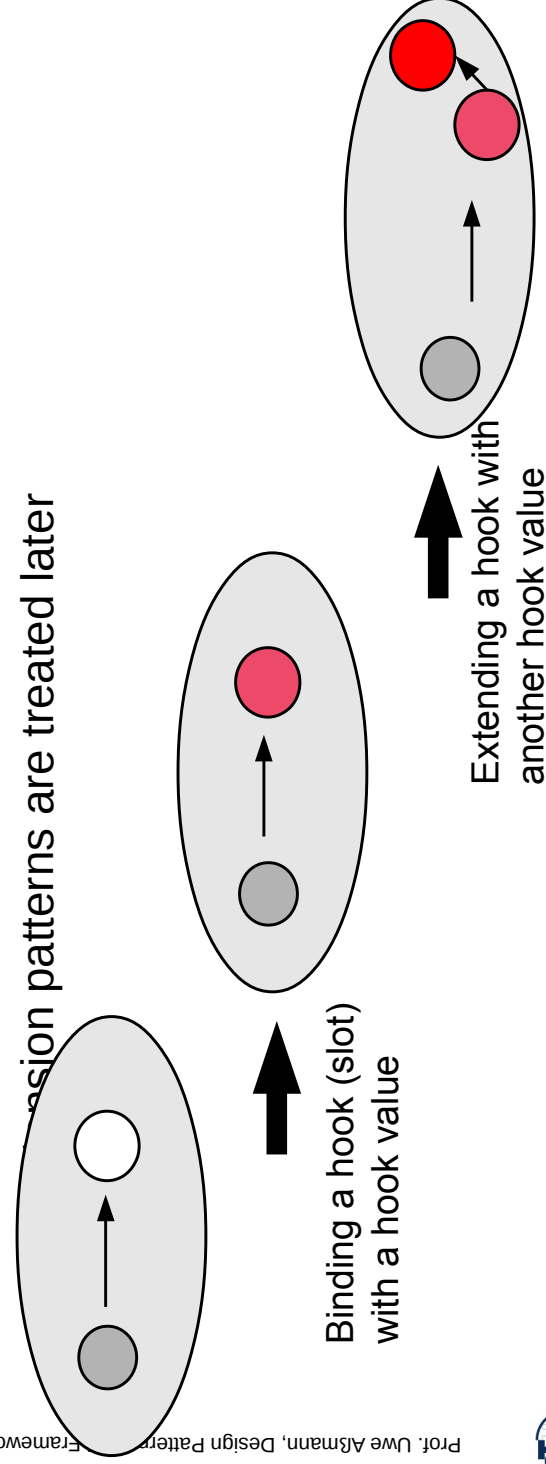

12

2.1.1 Template Method and Template Class

13



Design Patterns and Frameworks, © Prof. Uwe Alßmann

What Happens If We Reify the Hook Method?

- ▶ Methods can be reified, i.e., represented as objects
- ▶ In the TemplateMethod, the hook method can be split out of the class and put into a separate object
- ▶ Reification is done by another basic pattern, the Objectifier [Zimmer]

14



The Objectifier Pattern

- ▶ The pattern talks about basic polymorphism with objects (delegation)
 - Combined with an abstract class and abstract method
 - Clients call objects polymorphically

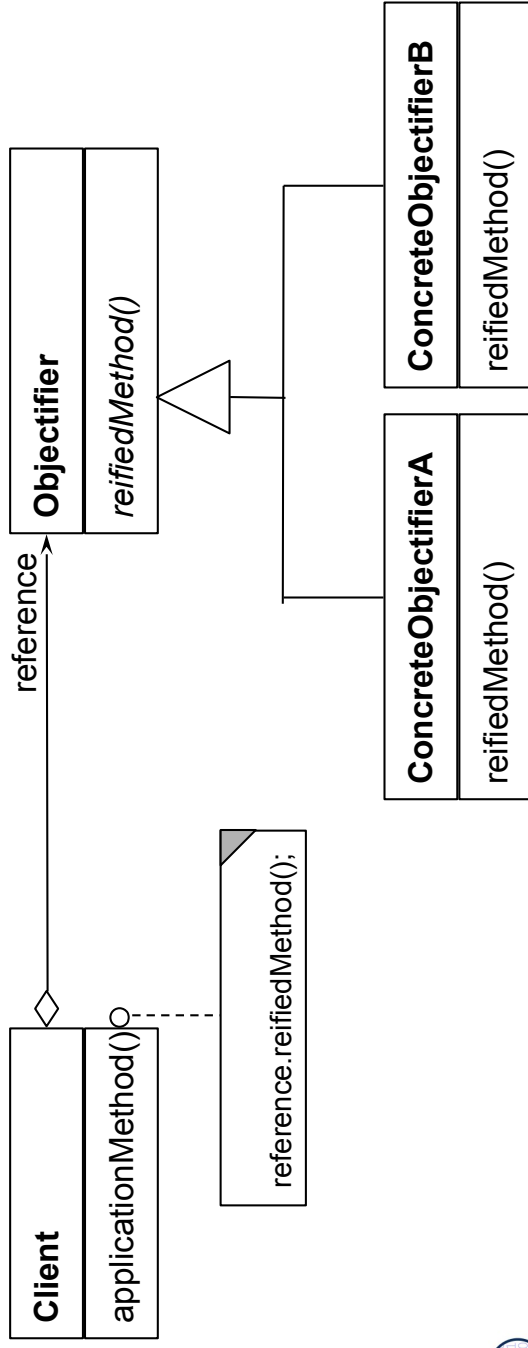

Ex. Different Students

- ▶ When preparing an exam, students may use different learning styles
- ▶ Instead of a method `learn()`, an objectified method, a `LearningStyle` class, can be used

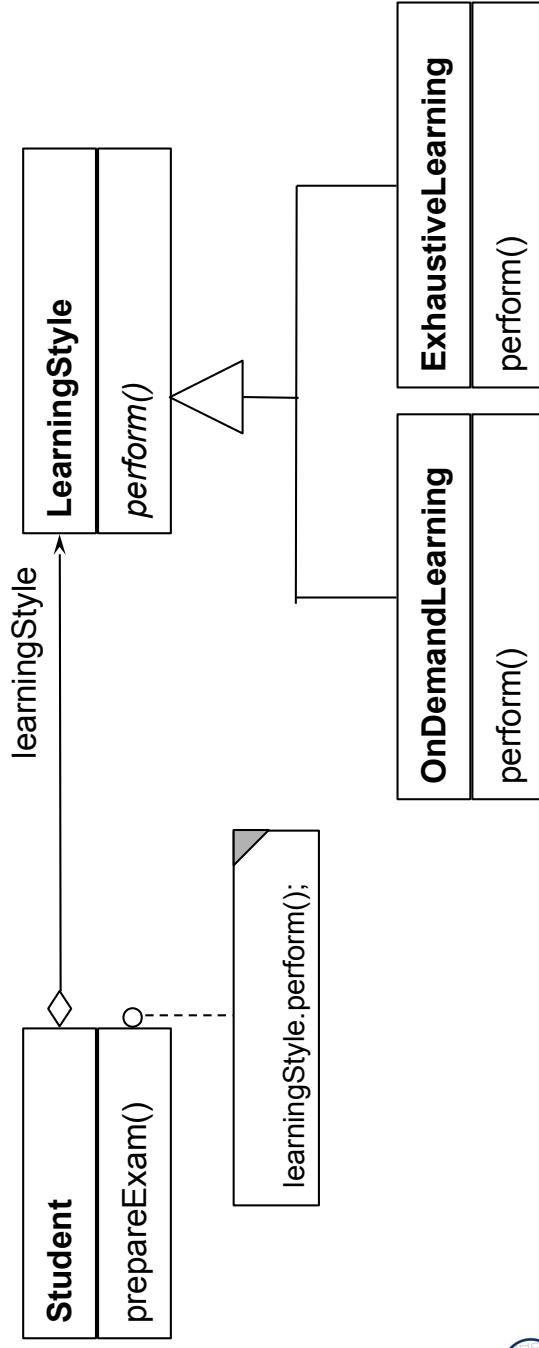

T&H on the Level of Classes

17

- ▶ With the Objectifier, we can build now Template&Hook classes
 - Additional roles for some classes
 - The template role
 - The hook role
- ▶ Resulting patterns:
 - Template Class
 - Generic Template Class
 - Dimensional Class Hierarchies for variability with parallel class hierarchies
 - Implementation of facets
 - Bridge, Visitor



Template Class

18

- ▶ Is combined from TemplateMethod and Objectifier
 - We explicitly fix a template class in the Objectifier
 - The template method and the hook method are found in different classes

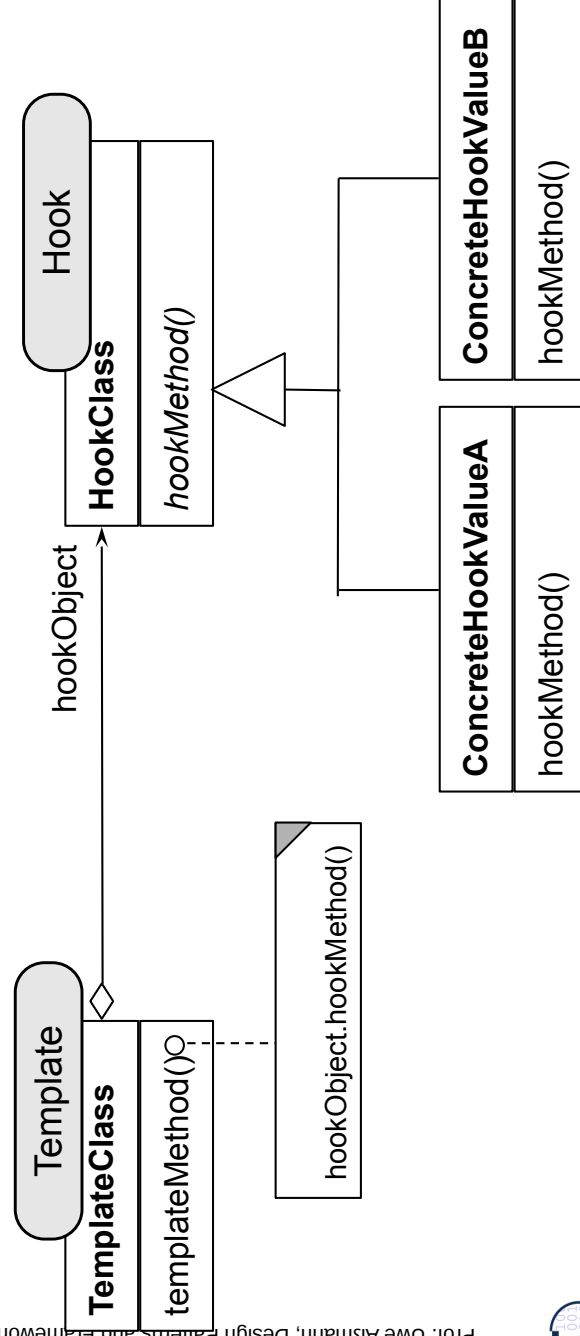

Template Class

19

- ▶ Similar to TemplateMethod, but
 - Hook objects and their hook methods can be exchanged at run time
 - Exchanging several methods (a set of methods) at the same time
 - Consistent exchange of several parts of an algorithm, not only one method
- ▶ This pattern is basis of
 - Bridge, Builder, Command, Iterator, Observer, Prototype, State, Strategy, Visitor.



Actors and Genres as Template Class

20

- ▶ Consistent exchange of recitation and dance behavior possible

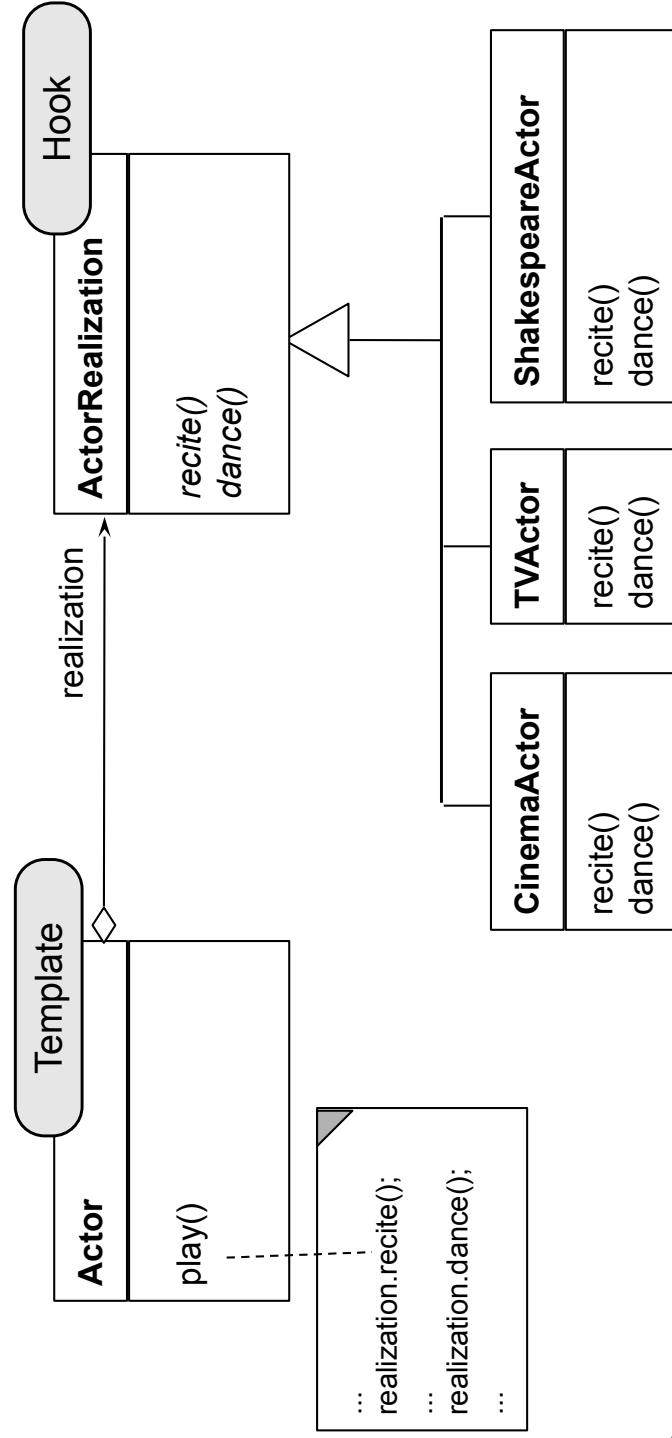

Variability with TemplateClass

▶ Binding the hook means to

- Derive a concrete subclass from the **abstract hook superclass**, providing the implementation of the hook

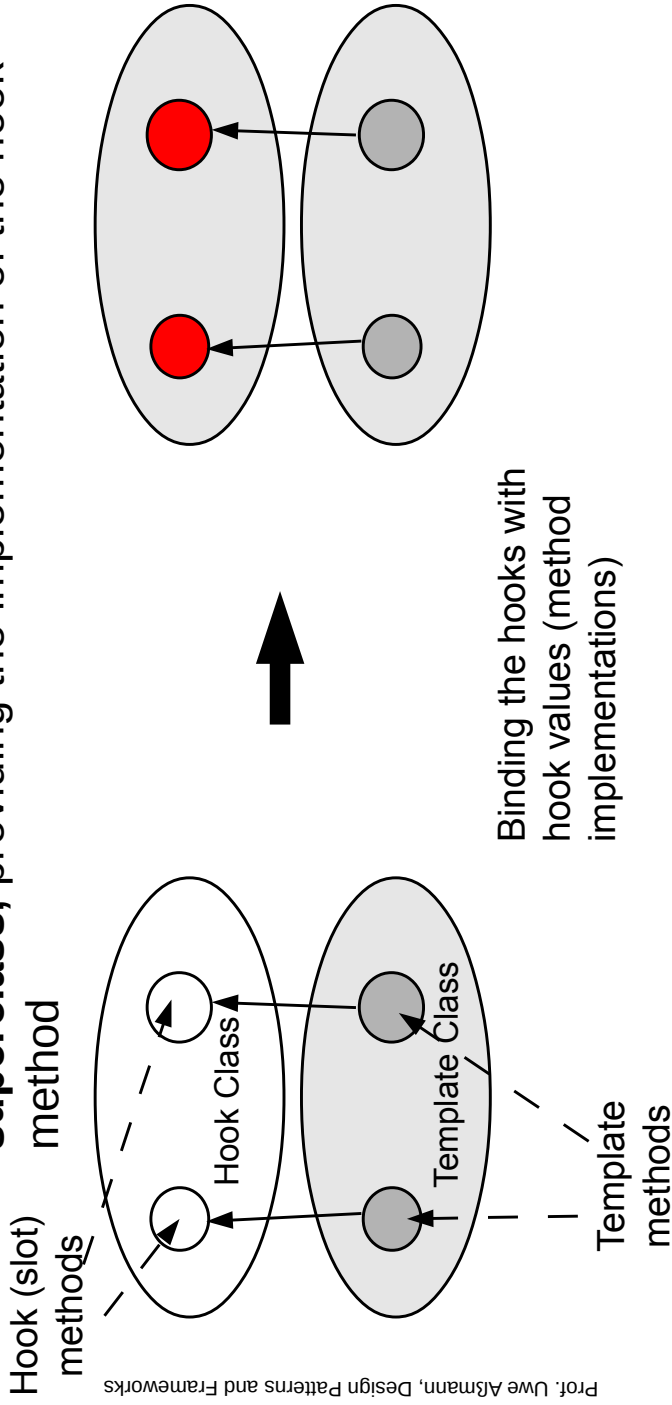

21

The GOF-Pattern Strategy

- ## ▶ The GOF-Strategy hands out the roles *client* and *algorithm*

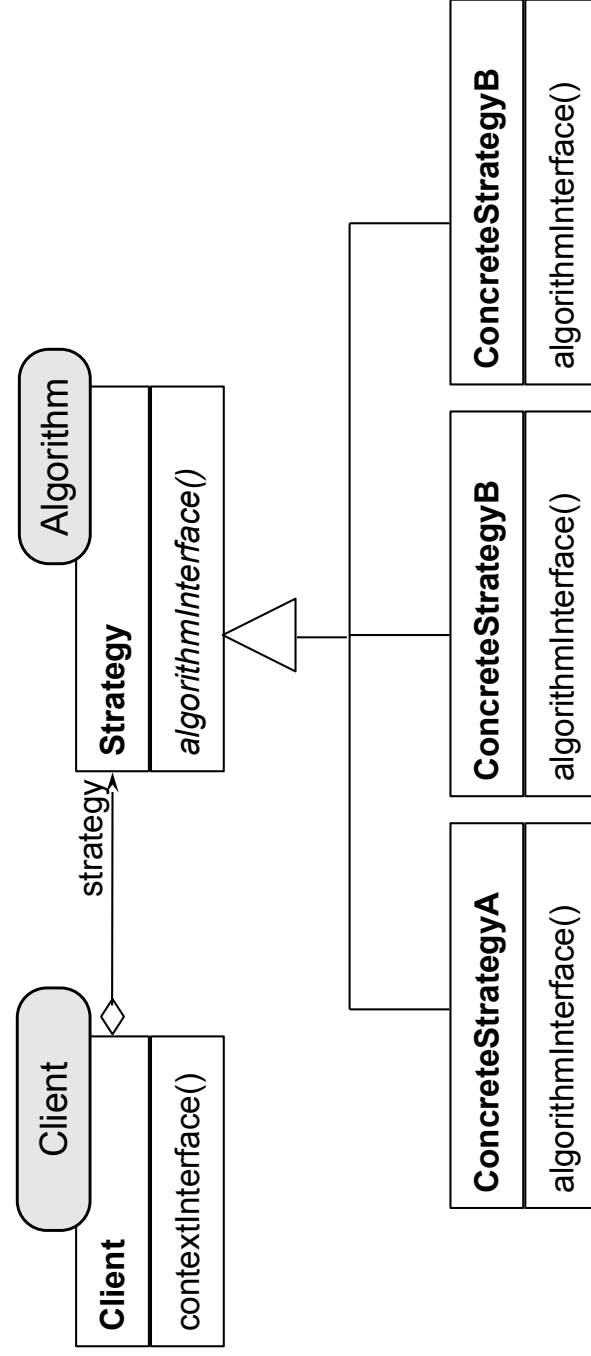

22

The GOF-Strategy Is Related To TemplateClass

23

- ▶ The GOF Strategy has the same structure as the Objectifier, but has a **different incentive**
 - It is not for reifying methods, but for varying methods only
- ▶ TemplateClass also has a different incentive
 - Hence, TemplateClass hands out other roles for the classes
 - The client class is considered as a template class
 - The strategy class as the hook class

Design Patterns may have the same structure and/or behavior, but can have a different incentive



Example for Strategy

24

- ▶ Encapsulate formatting algorithms

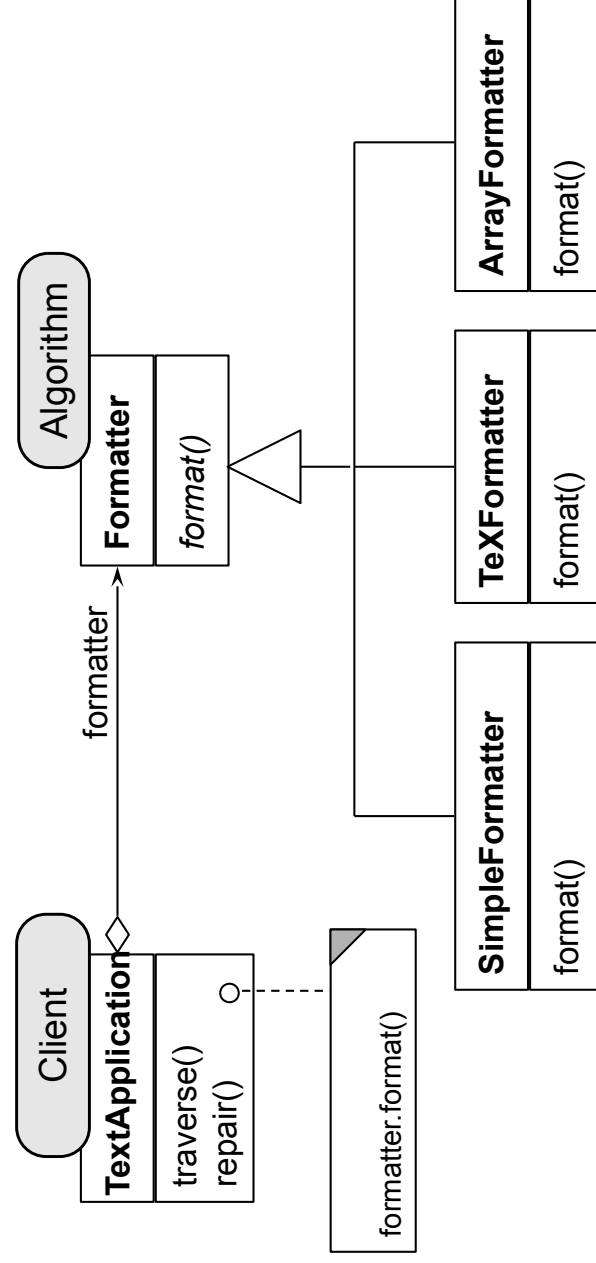

GenericTemplateClass

- ▶ In languages with generic classes (C++, Ada95, Java 1.5, C#, Sather, Cecil, Eiffel), TemplateClass can be realized with GenericTemplateClass
- ▶ The subclassing of the hook hierarchy is replaced by static generic expansion
 - Hence, more type safety, less runtime dispatch

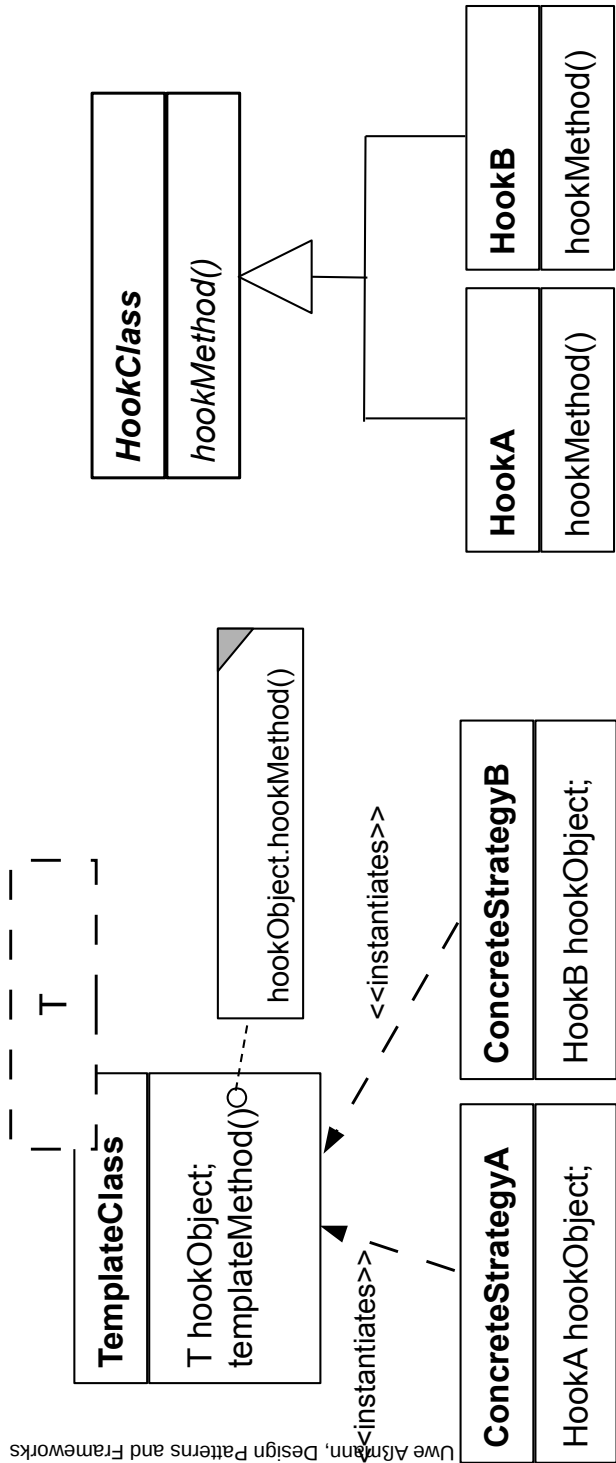

Generic Text Formatter

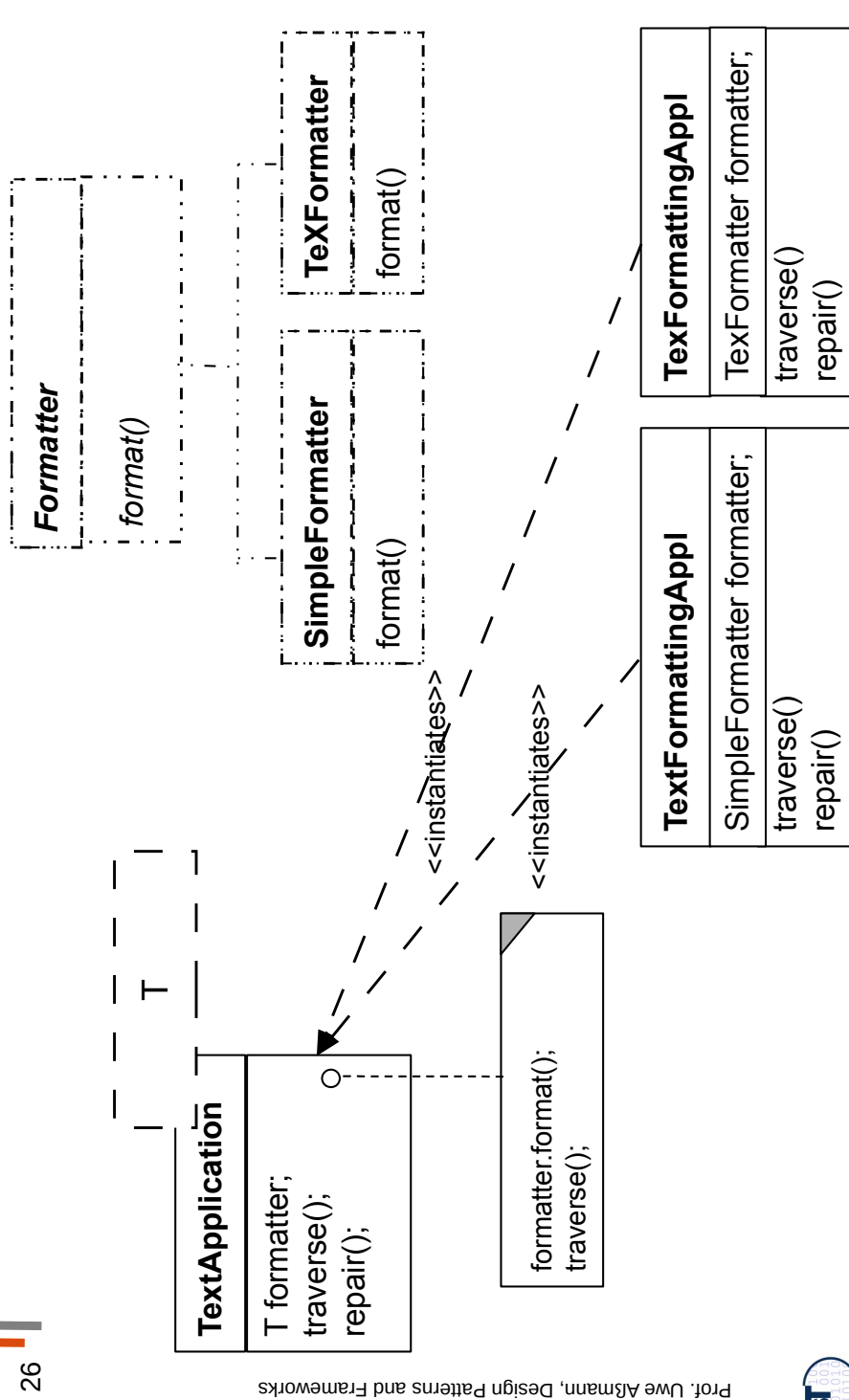

Further Work on Generic Template Parameterization

27

- ▶ See course CBSE
- ▶ GenVoca [Batory]
 - Generic template instantiation method for nested generics
 - Parameterization on many levels
 - Layered systems result
 - Realizable with nested C++ templates
 - See later
- ▶ Template Metaprogramming (www.boost.org)
 - Using template parameter for other purposes than hook classes

2.1.2 Dimensional Class Hierarchies and Bridge

28

Variability Pattern

Dimensional Class Hierarchies

29

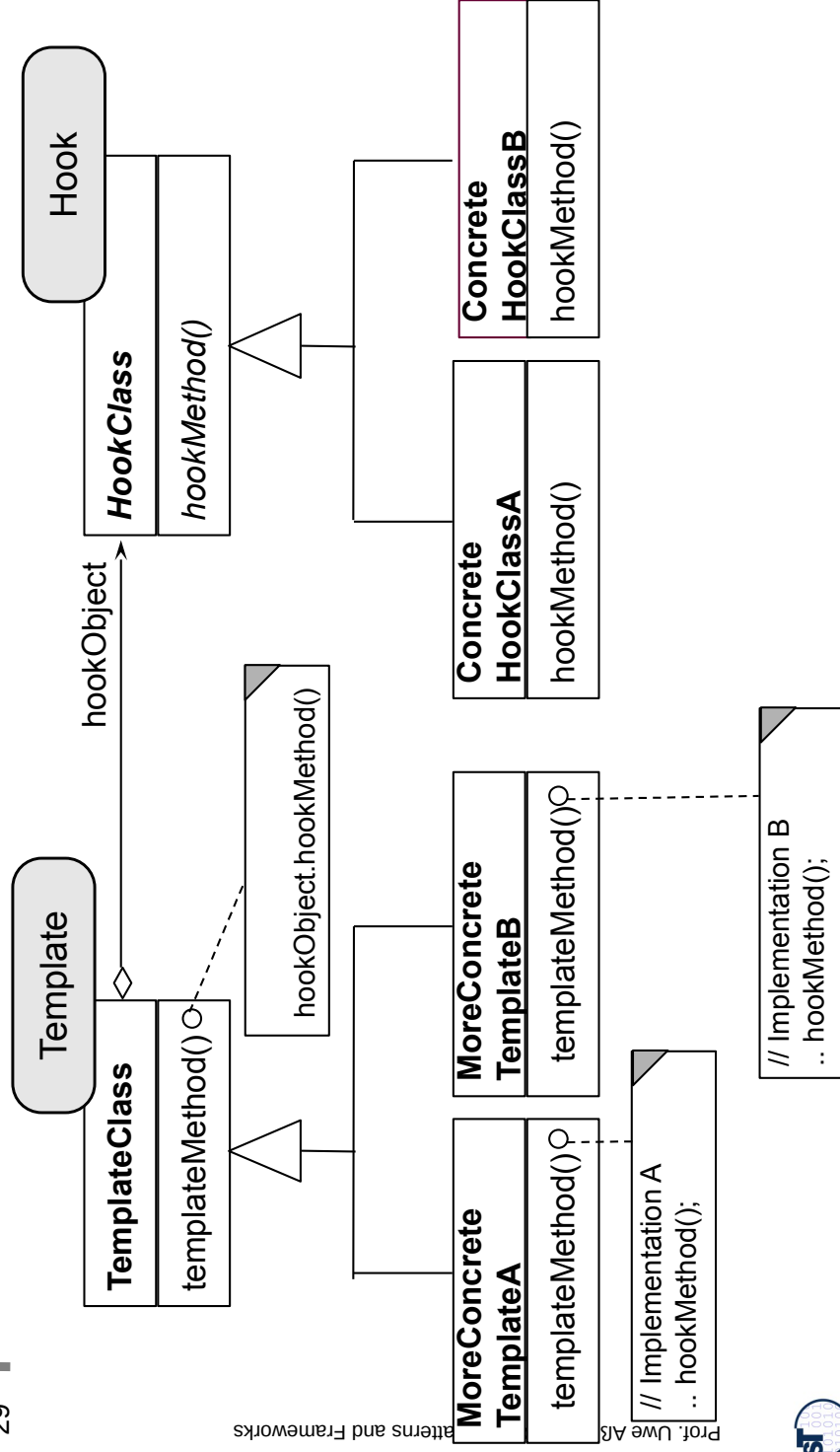

Dimensional Class Hierarchies

30

- ▶ Vary also the template class in a class hierarchy
 - The sub-template classes can adapt the template algorithm
 - Still, the template method calls the hook methods and reuses its results
 - Important: the sub-template classes must fulfil the *contract* of the superclass
 - Although the implementation can be changed, the interface and visible behavior must be the same
- ▶ Upper and lower layer (dimension)
 - Template method (upper layer) calls hook methods (lower layer)
- ▶ Both hierarchies can be varied independently
 - Factoring (orthogonalization)
 - Reuse is increased

GOF Pattern "Bridge"

- ▶ The Bridge pattern is a variant of Dimensional Class Hierarchies, with different incentive
- ▶ The left hierarchy is called *abstraction hierarchy*, the right *implementation*
 - Also *handle vs body*
- ▶ However, most important is the separation of two hierarchies

31



Remember Dimensional Class Hierarchy (Bridge with Template/Hook Constraint)

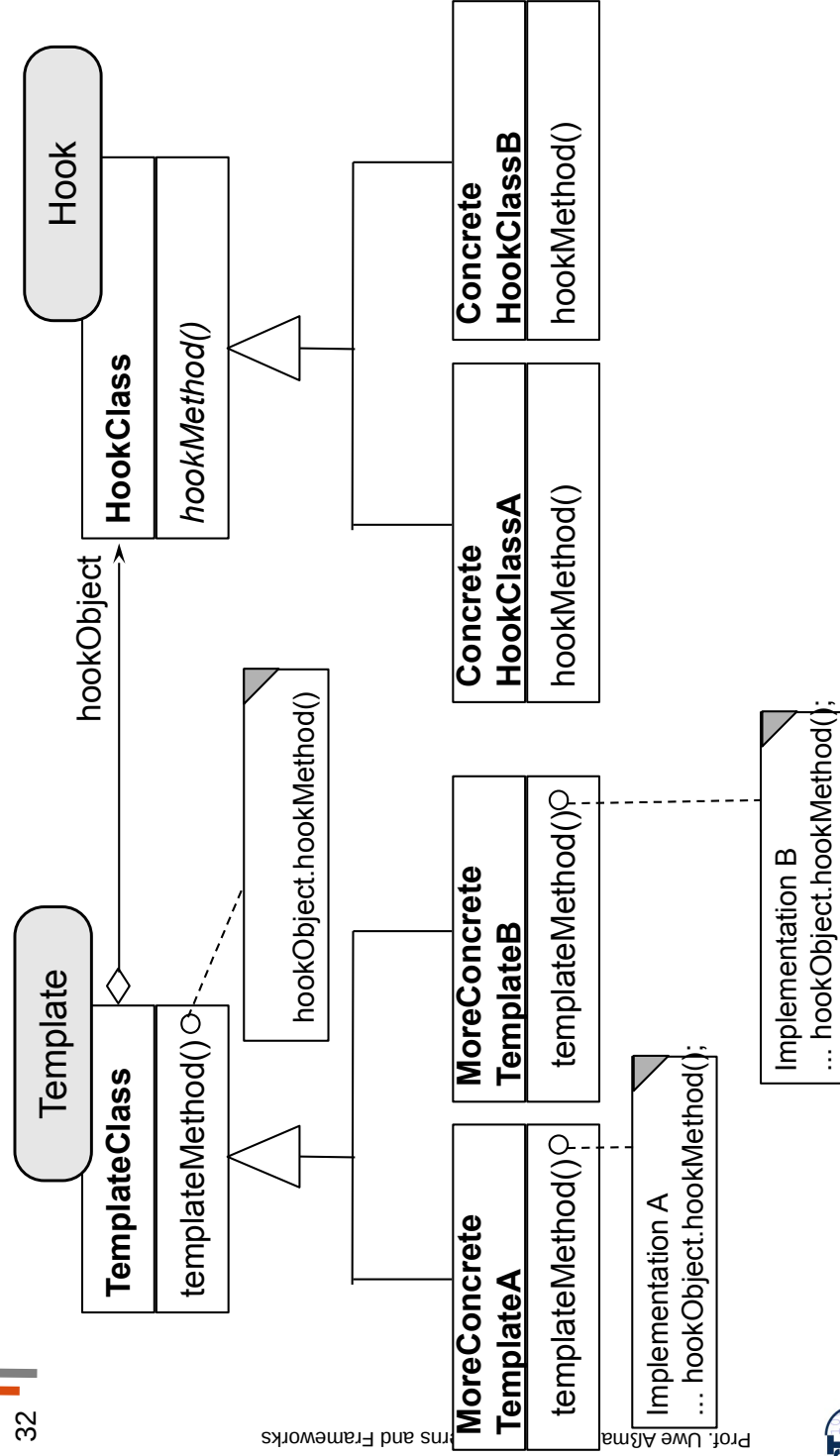

32



Bridge

Different incentive (Abstraction/Implementation)

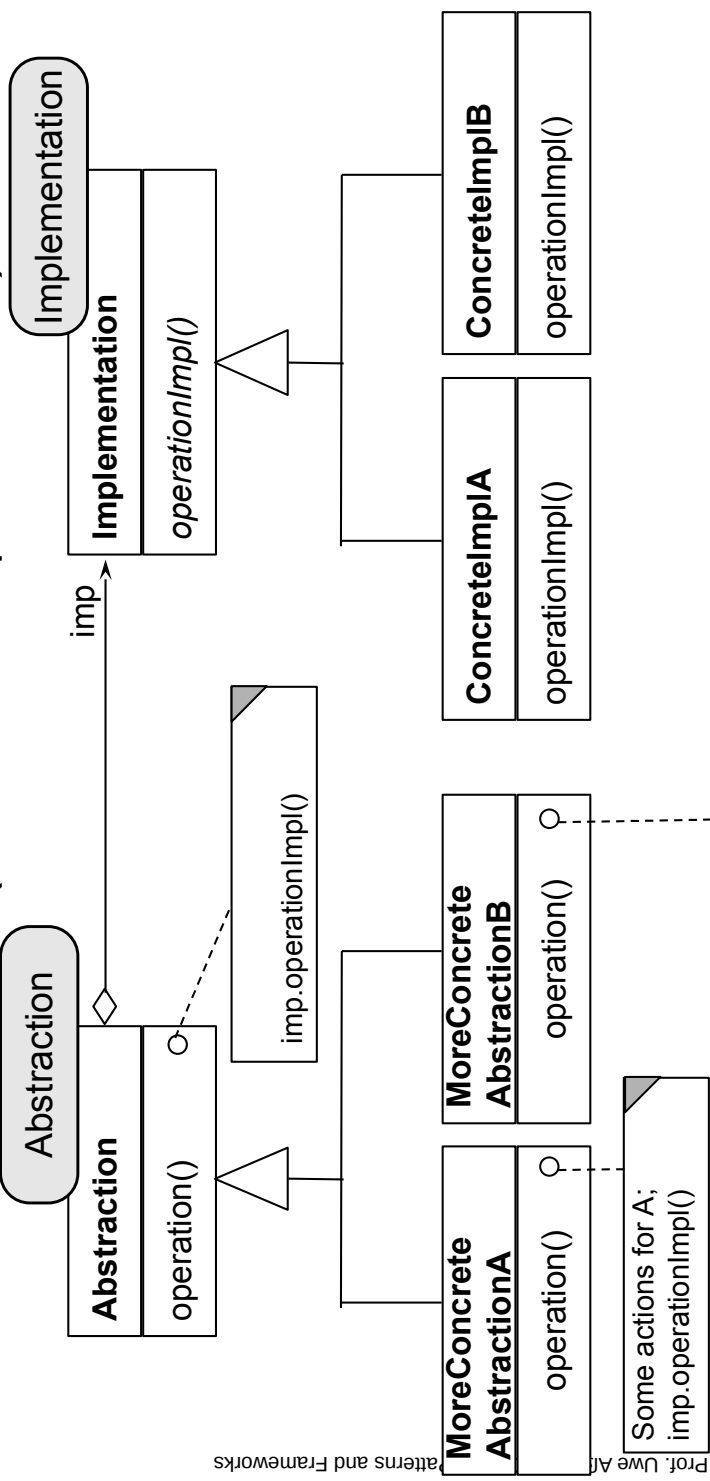

Example: DataGenerator as Bridge

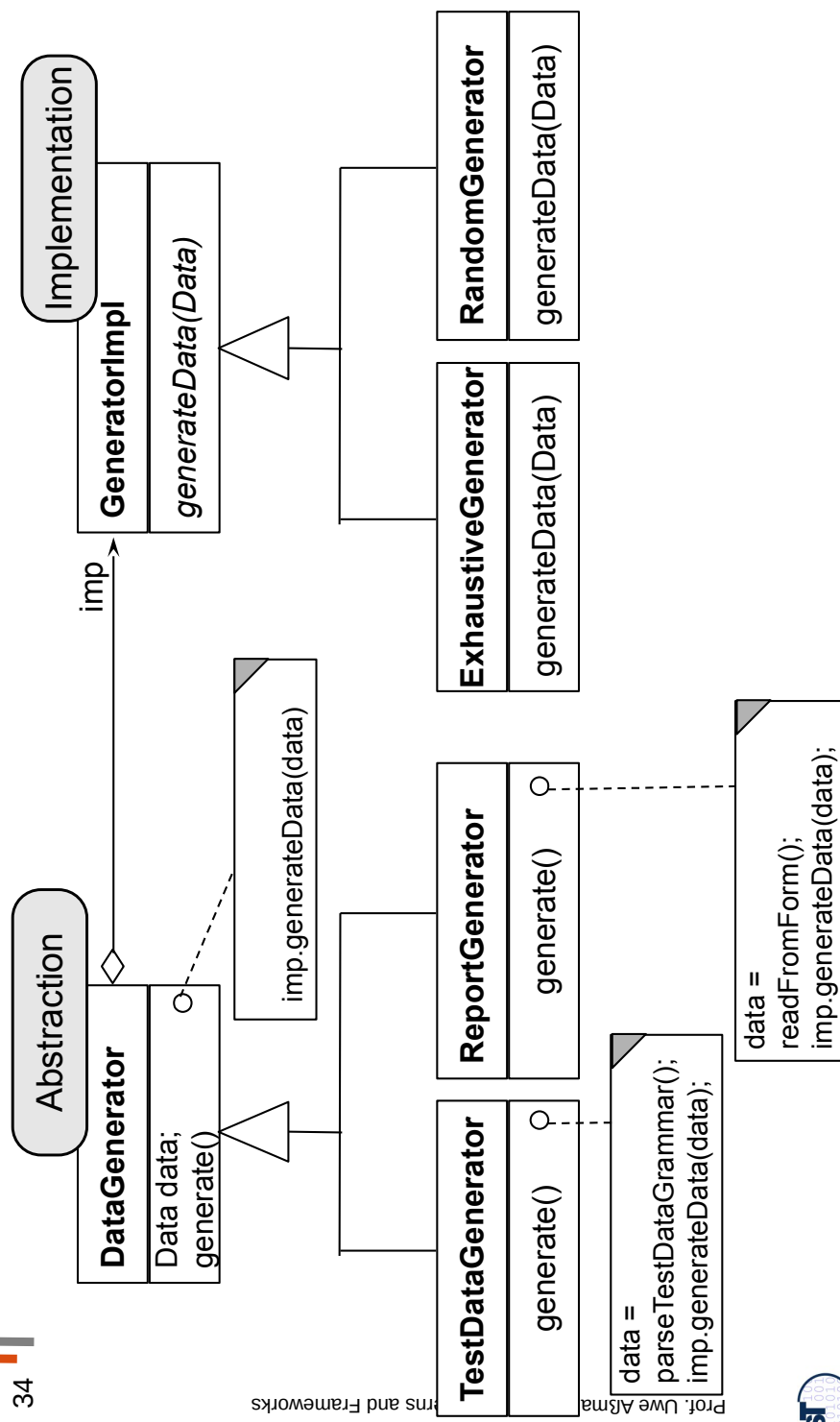

Bridge

- ▶ Both hierarchies can be varied independently
 - Factoring (orthogonalization)
 - Reuse is increased
- ▶ An abstraction can have several Bridges
 - Bridges can be replicated
 - Basis for implementation of facets

35



Multiple Bridges DataGenerator as 2-Bridge

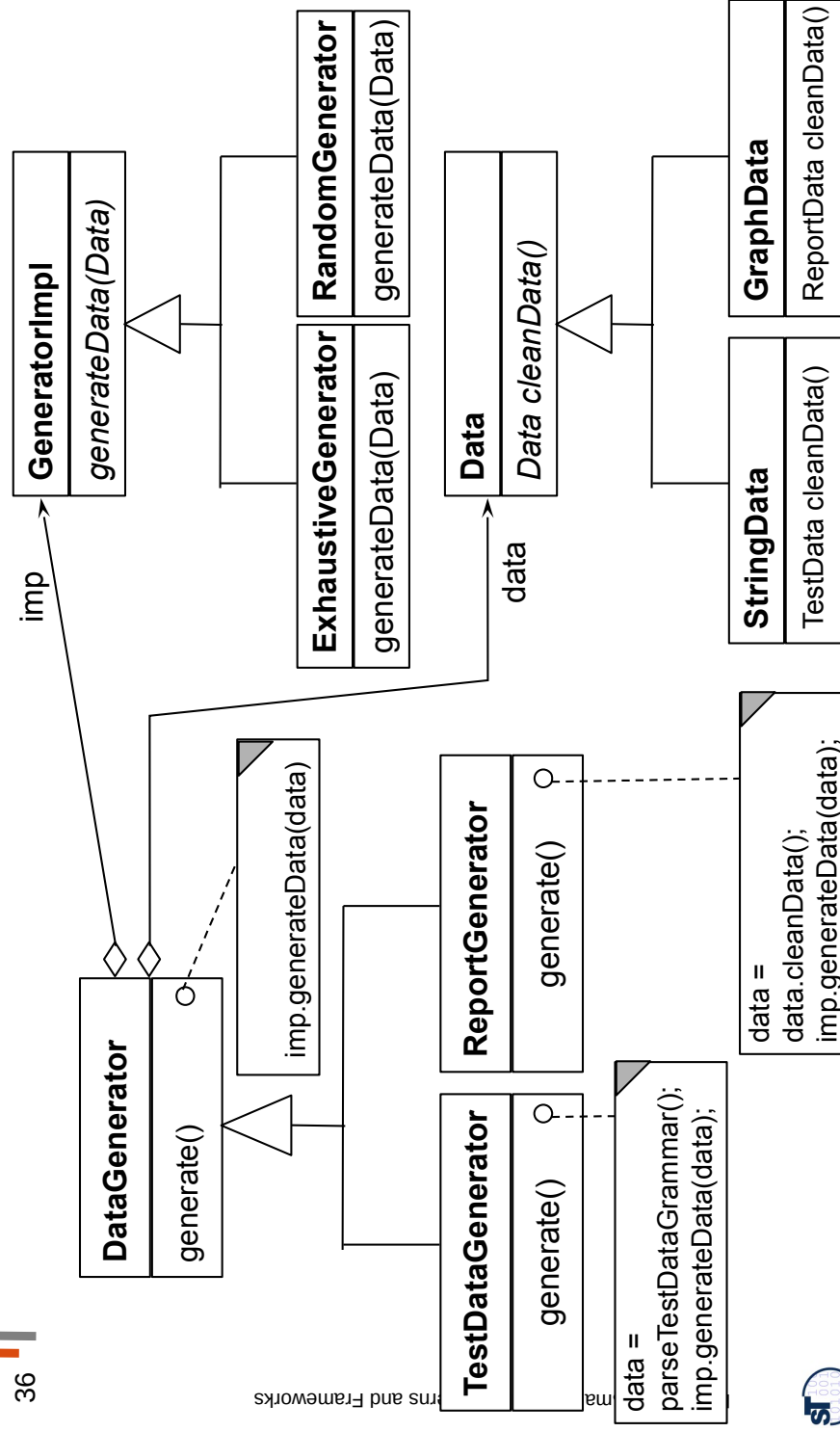

36



Basic Variability Patterns - Overview

37

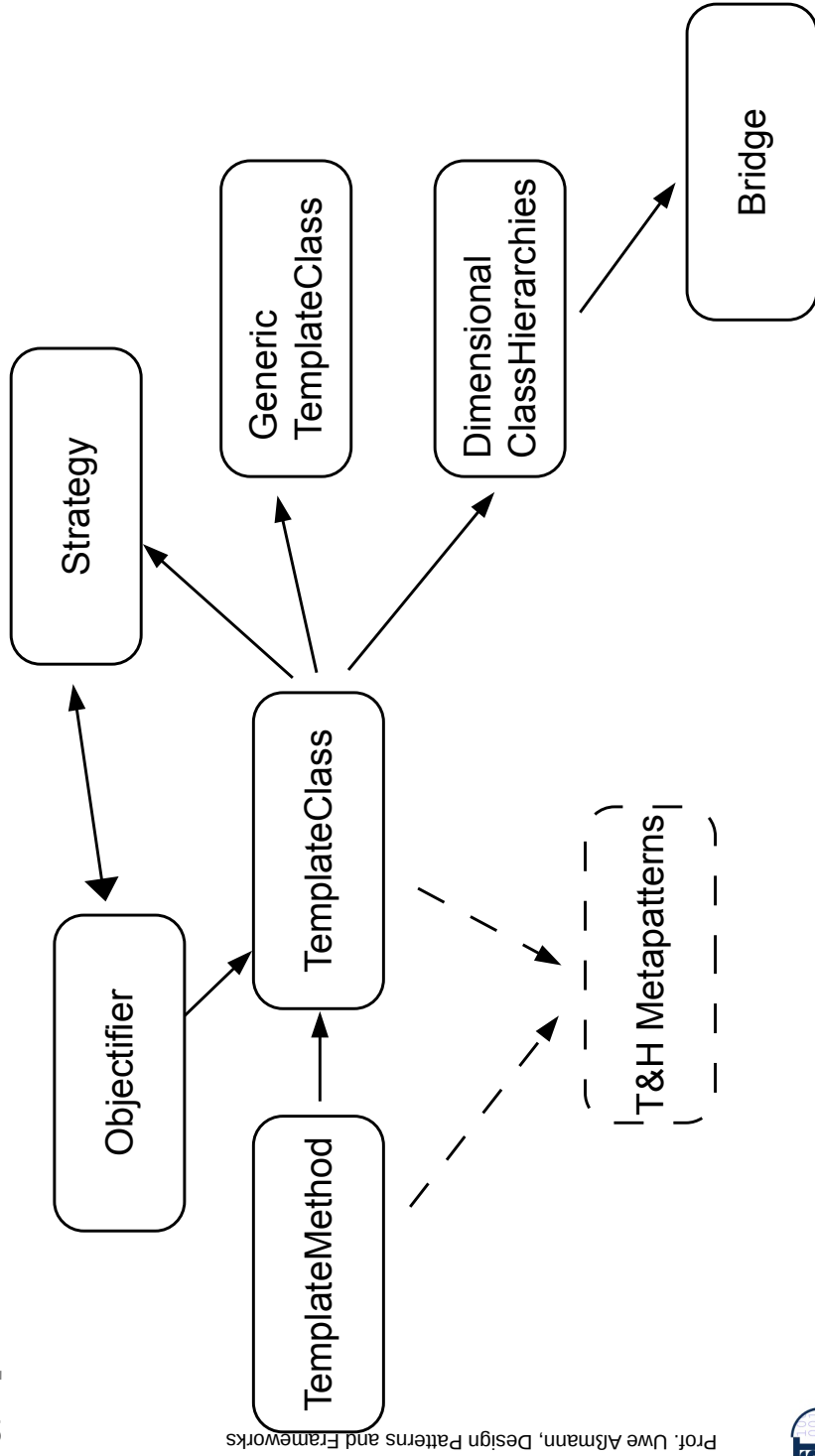

Relations of Basic Patterns

38

▶ Pre book vs Gamma book

- Pree and the GOF worked together for some time, but then they published two different books
- Pree's focus was on templates and hooks (framework patterns)
- GOF on arbitrary patterns in arbitrary context
- ▶ One can take any GOF pattern and make it a framework pattern by introducing the template-and-hook constraint
 - Or if you take away the template-hook constraint from a framework pattern, you get an unconstrained general pattern

Relation TemplateMethod, TemplateClass, Strategy, Observer

39

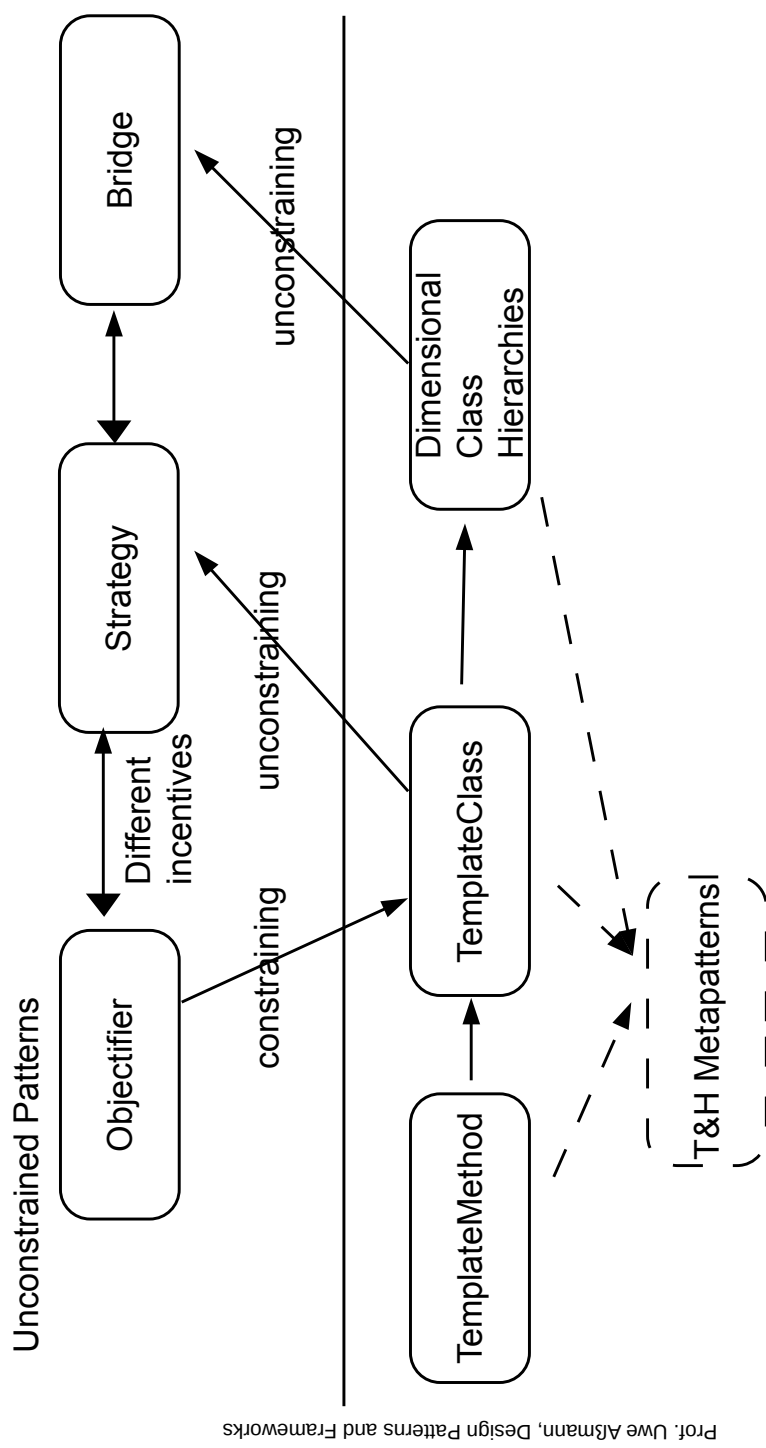

Prof. Uwe Alsmann, Design Patterns and Frameworks



Template/Hook Patterns

2.1.3 Parallel Class Hierarchies (Bridges with Constraints)

40



When the Dimensions cannot be Independently Varied

- ▶ Sometimes, the dimensions of a DimensionalClassHierarchies are not independent
- ▶ Instead, if it is varied on the left, also on the right must be varied
- ▶ Dimensions have equal size and structure, i.e., are isomorphic
- ▶ Typically are container classes and their elements
 - UML diagrams and their node and edge types
 - Figures and their figure elements
 - Record lists and their record types

41



Parallel Hierarchies with Parallelism Constraint

- ▶ Both hierarchies, collection and element, must be varied consistently

42

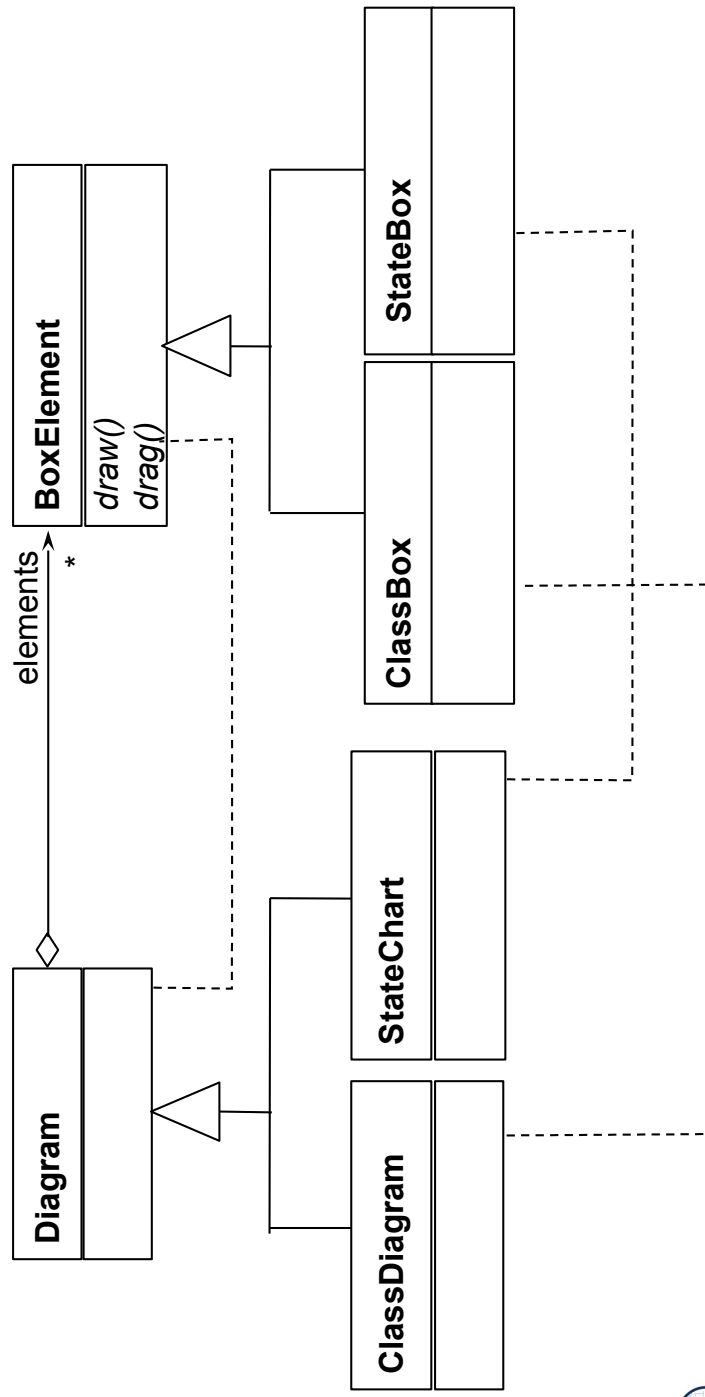

2.1.4 Visitor

43



Design Patterns and Frameworks, © Prof. Uwe Alßmann

Visitor - Purpose

44

- ▶ The Visitor is a variant of the DimensionalClassHierarchies pattern
 - Template class hierarchy models a polymorphic data structure
 - In most cases a tree
- ▶ Hook hierarchy models a polymorphic algorithm
 - Encapsulate an operation on a collection (tree) of objects as an object
 - Hook is an objectifier pattern (reified method)
- ▶ Separate tree inheritance hierarchy from command hierarchy
 - Simple extensibility of both hierarchies
 - Factoring (orthogonalization): simpler inheritance structures, otherwise multiplication of classes



Visitor

Implementation of a 2-dimensional structure

- First dispatch on dimension 1 (data structure), then on dimension 2 (algorithm)

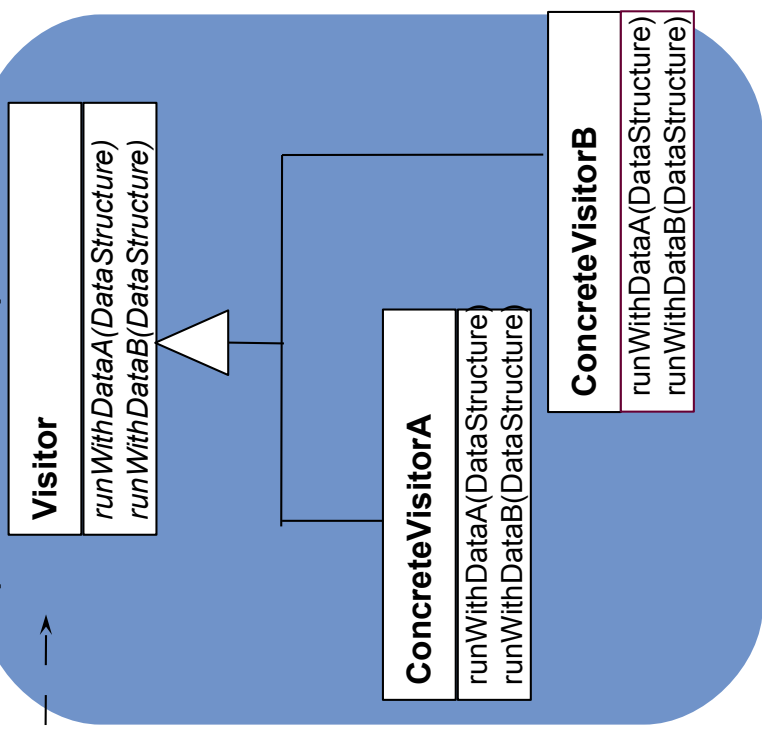
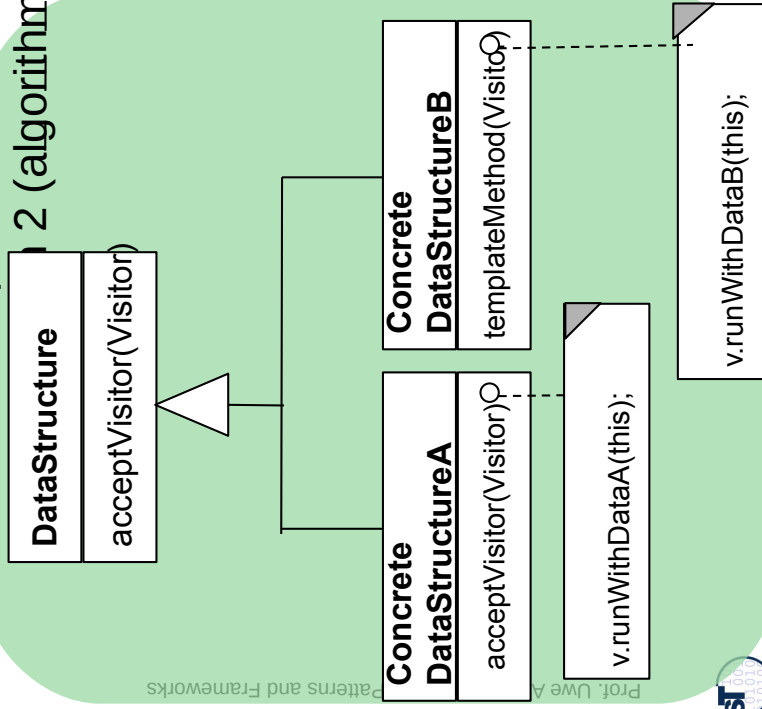

Structure for Visitor in Layers

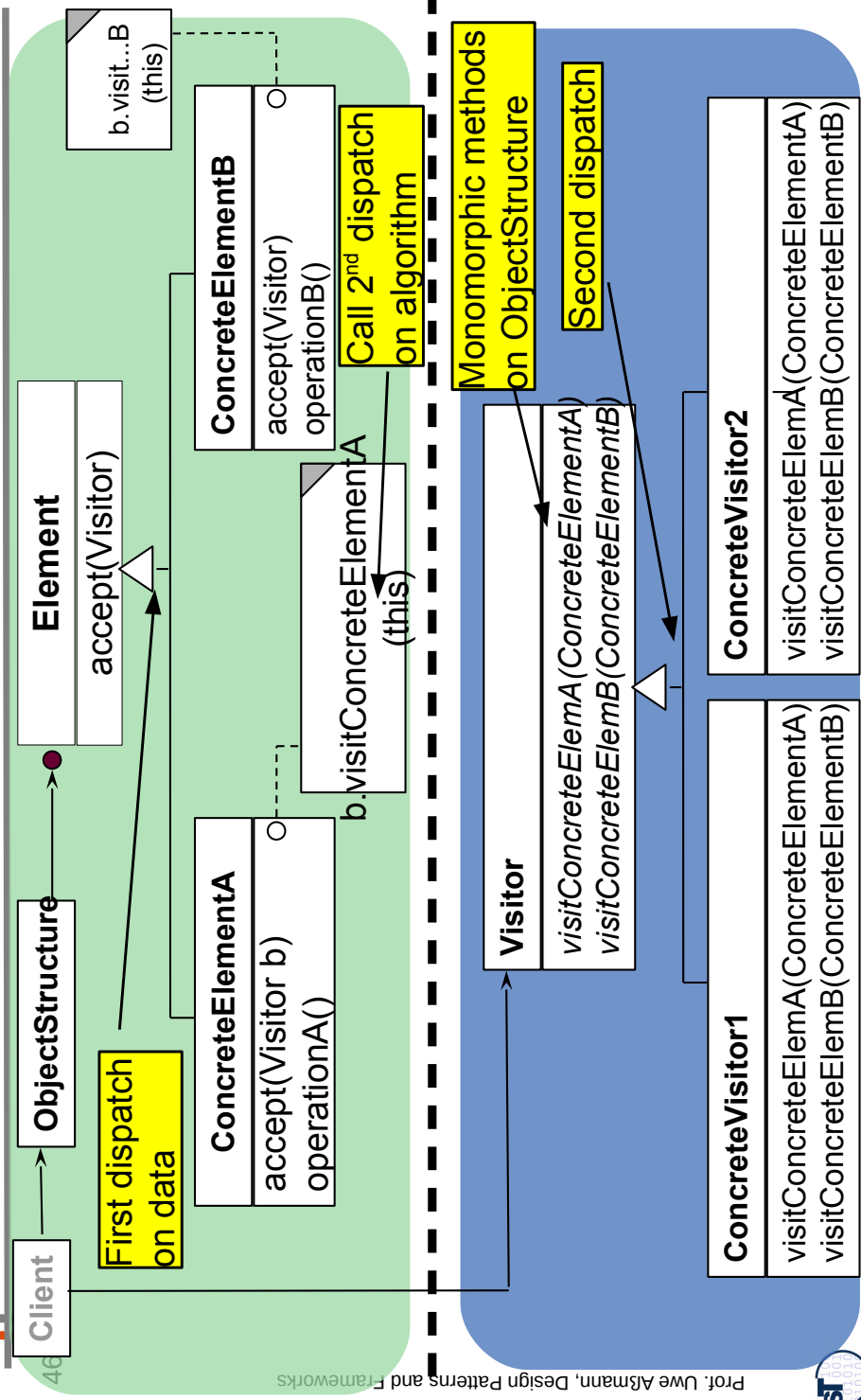

Sequence Diagram Visitor

- ▶ First dispatch on data, then on visitor

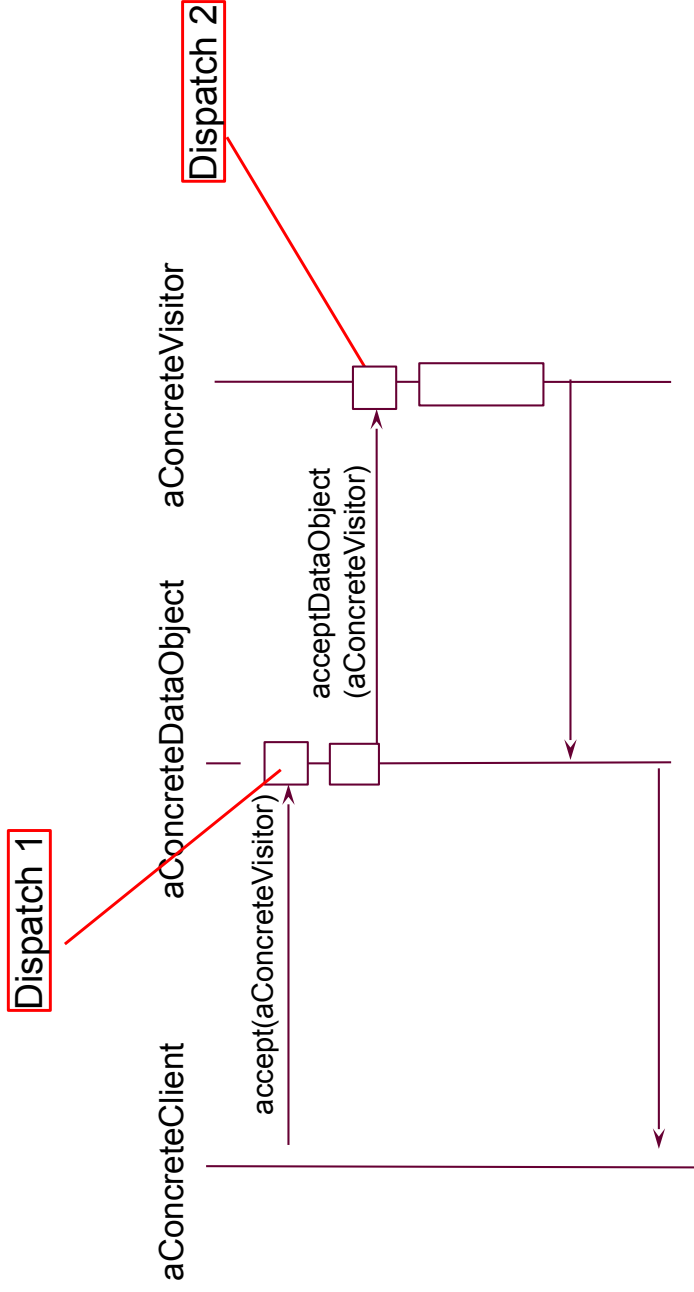

47

Visitor

- ▶ Implementation of a dimensional structure, in which one dimension is an algorithm
 - First dispatch on dimension 1 (data structure), then on dimension 2 (algorithm)
 - The dimensions, however, are not independent (no facets): the chosen implementation of the algorithm depends on the chosen implementation of the data
- ▶ Abbreviation for **multimethods**
 - Dispatch/polymorphism on two arguments, not only the first (double dispatch)
 - First dispatch on tree object (method *accept*), then operation (method *visit*) objects

48

Remember: DimensionalClassHierarchies

49

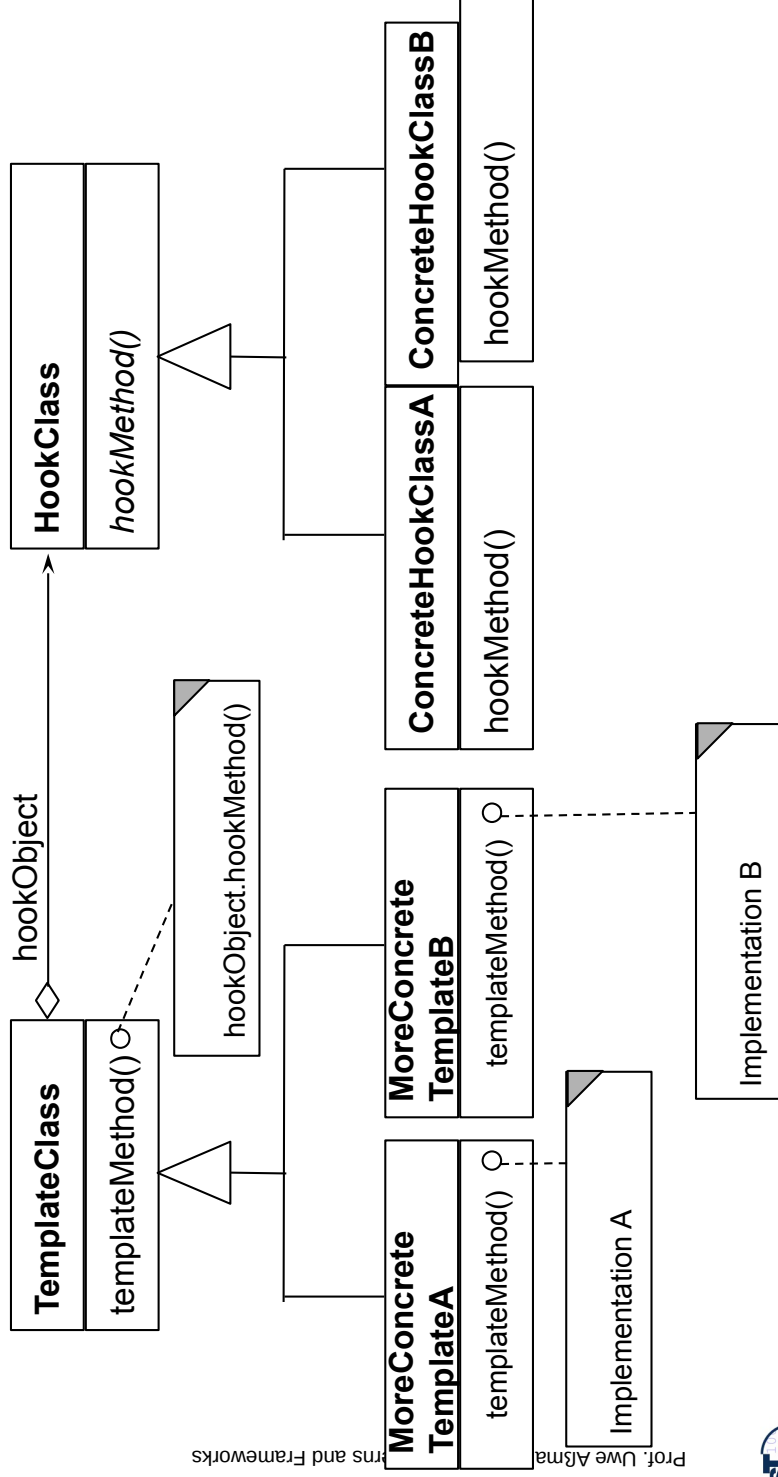

Prof. Uwe Alsmann and Frameworks



Visitor

Usually is missing, replaced by Visitor argument

50

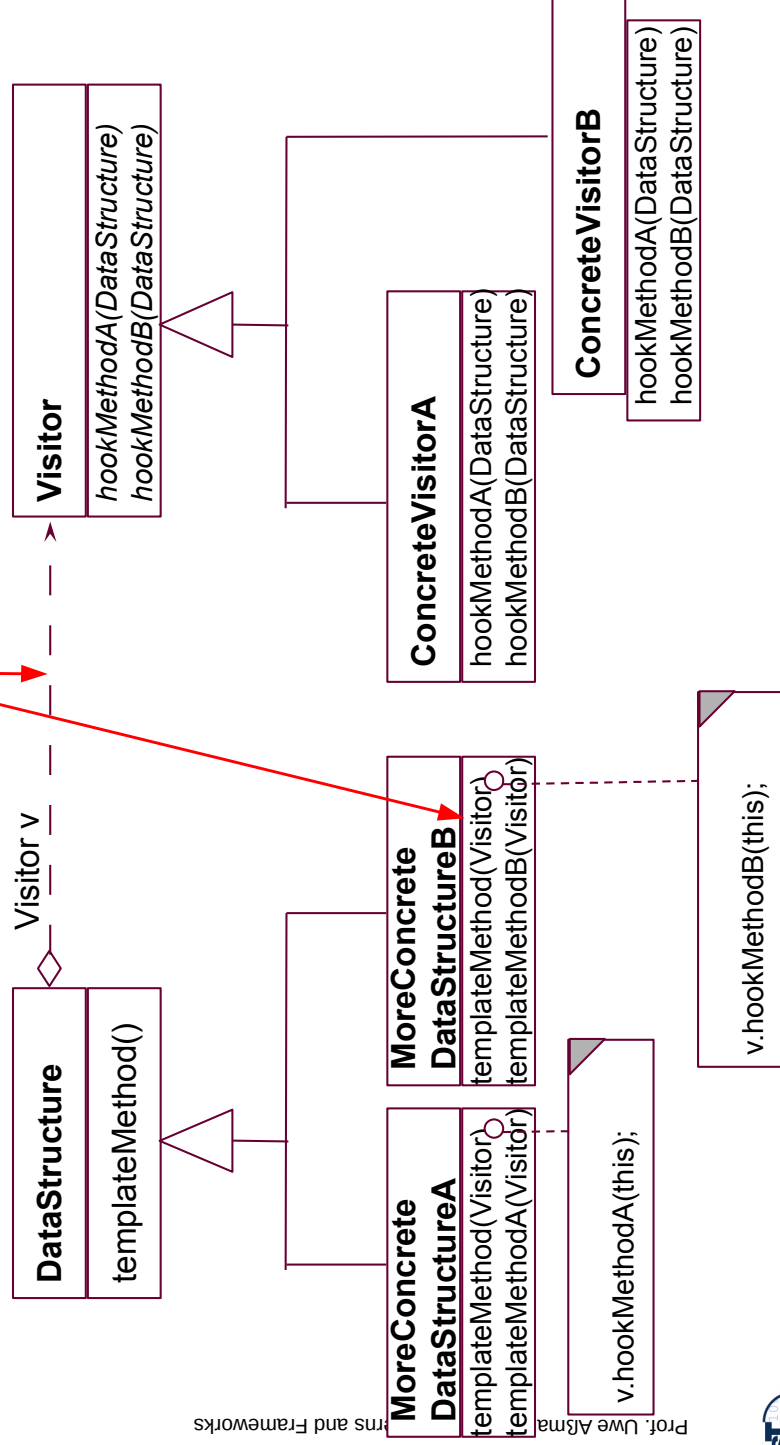

Prof. Uwe Alsmann and Frameworks



Visitor As Multimethod

51

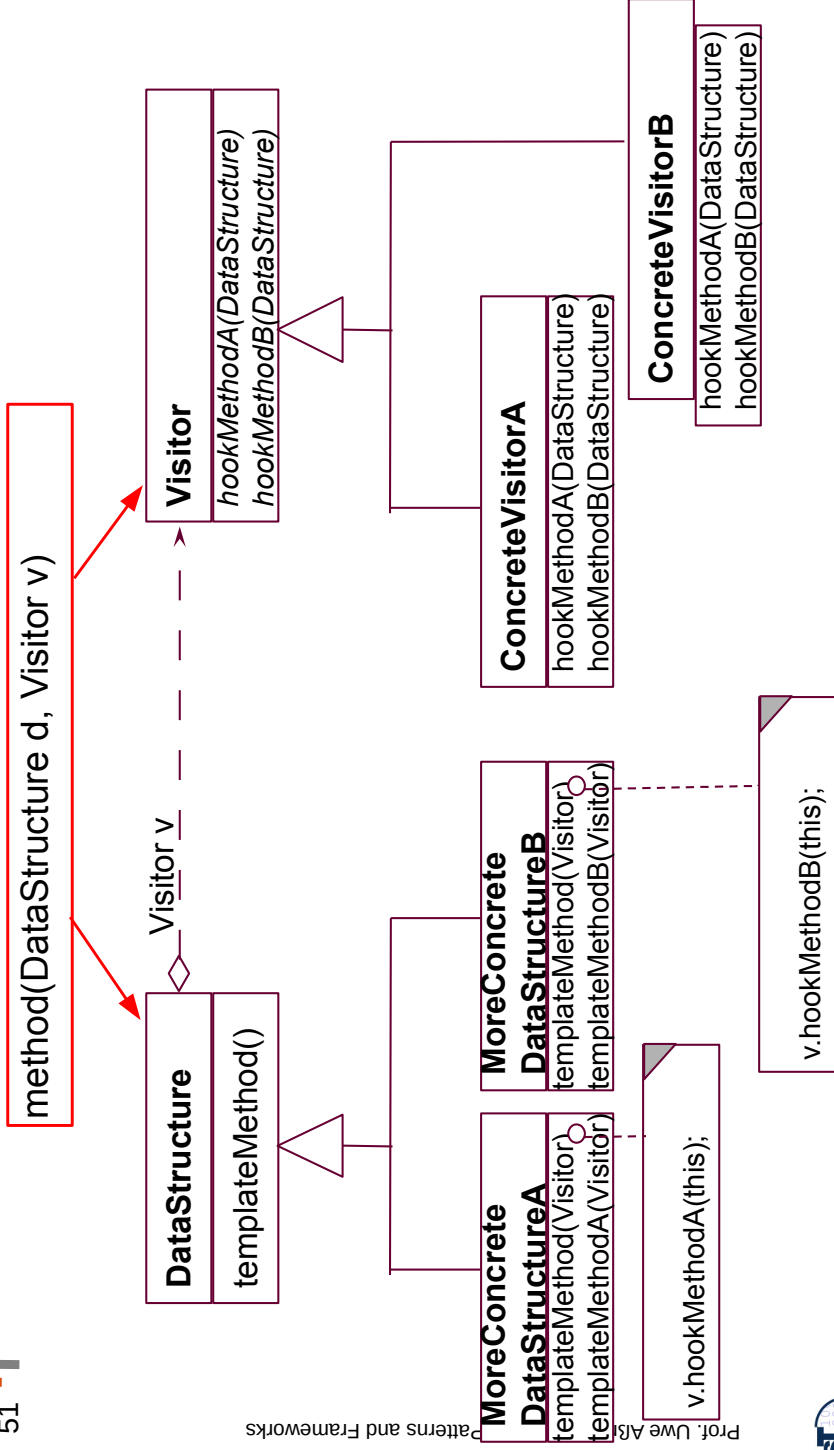

Example: Data Structures (Syntax Trees) in a Compiler or Software Tool

52

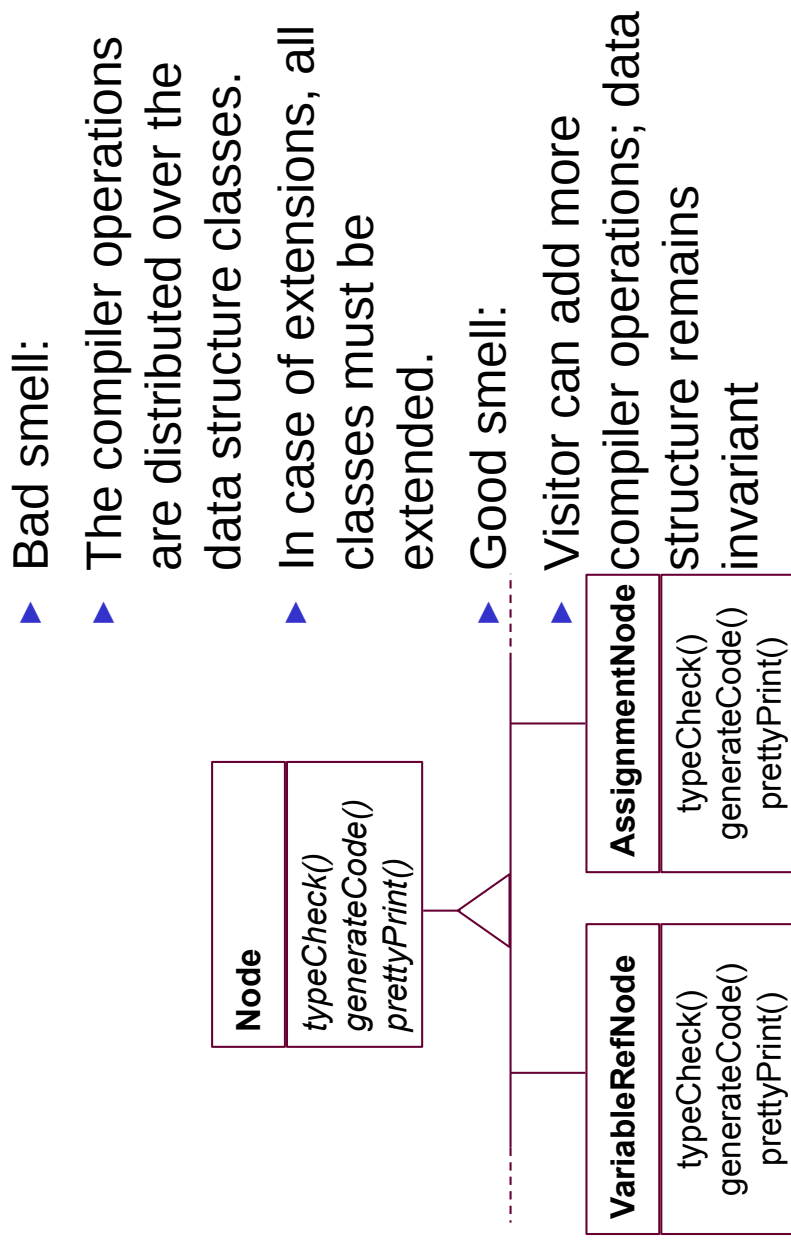

- ▶ Bad smell:
- ▶ The compiler operations are distributed over the data structure classes.
- ▶ In case of extensions, all classes must be extended.
- ▶ Good smell:
- ▶ Visitor can add more compiler operations; data structure remains invariant

Working on Syntax Trees of Programs with Visitors

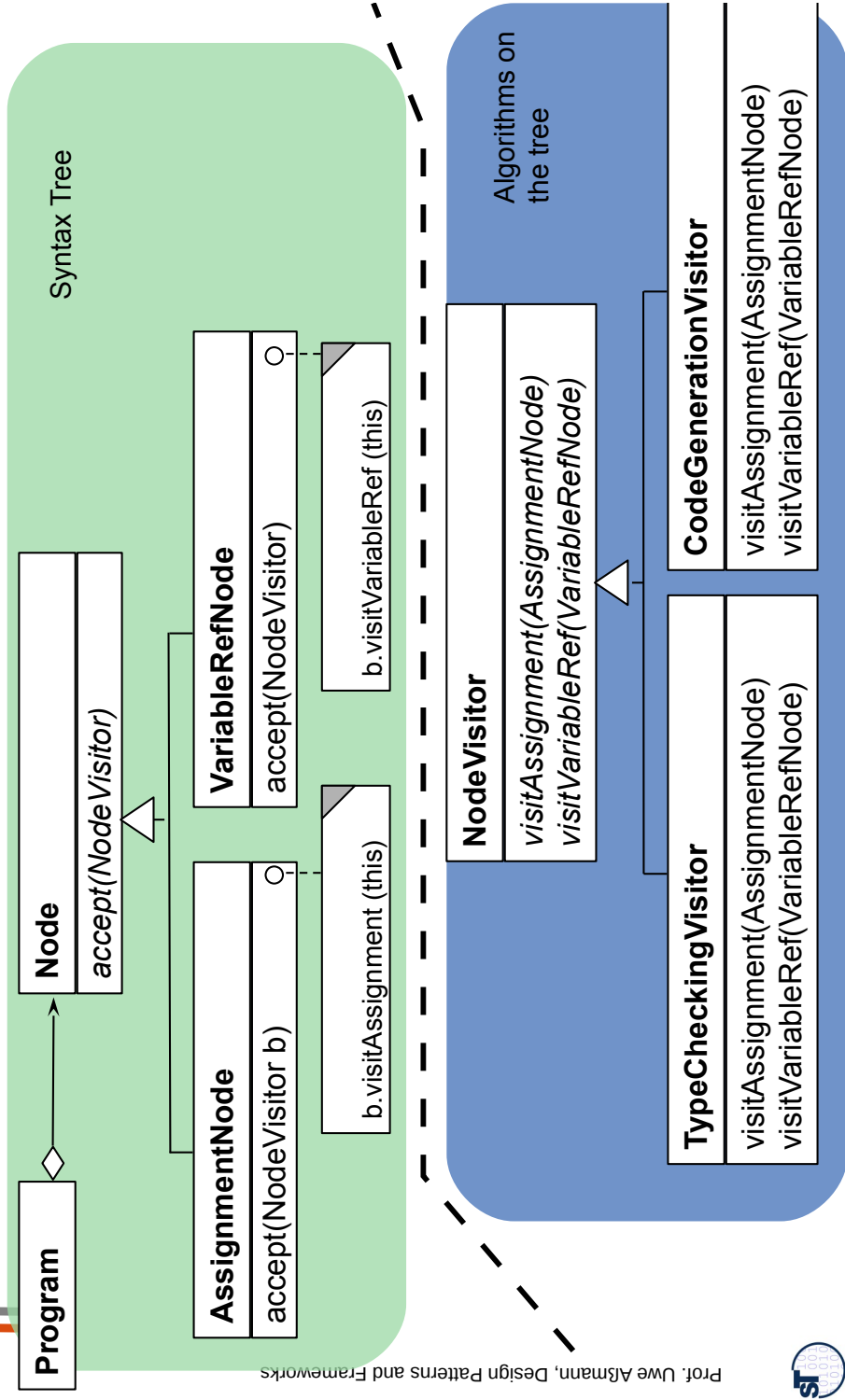

2) Dimensional Class Hierarchies (Bridges) as an Implementation of Facet Classifications

... in the following, we use the patterns
Bridge and
DimensionalClassHierarchies
interchangeably

Facet Classifications

55

- ▶ A facet is an orthogonal dimension of a model
 - Every facet has its separate model
 - All facet classes are abstract
- ▶ Facets factorize inheritance hierarchies
 - Hence, facets simplify inheritance hierarchies
- ▶ Final, concrete classes in the (combined) model inherit from every dimension (every facet)
 - All classes in facets are *independent*, i.e., don't know of each other
 - A final class offers the union of all features

55

56

- ▶ "Let me try to explain to you, what to my taste is characteristic for all intelligent thinking. **It is, that one is willing to study in depth an aspect of one's subject matter in isolation for the sake of its own consistency, all the time knowing that one is occupying oneself only with one of the aspects.** We know that a program must be correct and we can study it from that viewpoint only; we also know that it should be efficient and we can study its efficiency on another day, so to speak. In another mood we may ask ourselves whether, and if so: why, the program is desirable. But nothing is gained --on the contrary!-- by tackling these various aspects simultaneously.”
- ▶ E. W. Dijkstra “On the Role of Scientific Thought”, EWD 447 Selected Writings on Computing: A Personal Perspective, pages 60–66, 1982.

Separation of Concerns (SOC)

57

- ▶ It is what I sometimes have called "the separation of concerns", which, even if not perfectly possible, is yet the only available technique for effective ordering of one's thoughts, that I know of. This is what I mean by "focussing one's attention upon some aspect": it does not mean ignoring the other aspects, it is just doing justice to the fact that from this aspect's point of view, the other is irrelevant. It is being one- and multiple-track minded simultaneously.
- ▶ Intelligent thinking and scientific thought:
- ▶ Scientific thought comprises "intelligent thinking" as described above. A scientific discipline emerges with the --usually rather slow!-- discovery of which aspects can be meaningfully "studied in isolation for the sake of their own consistency", in other words: with the discovery of useful and helpful concepts. Scientific thought comprises in addition the conscious search



Facets of the Data Generator

58

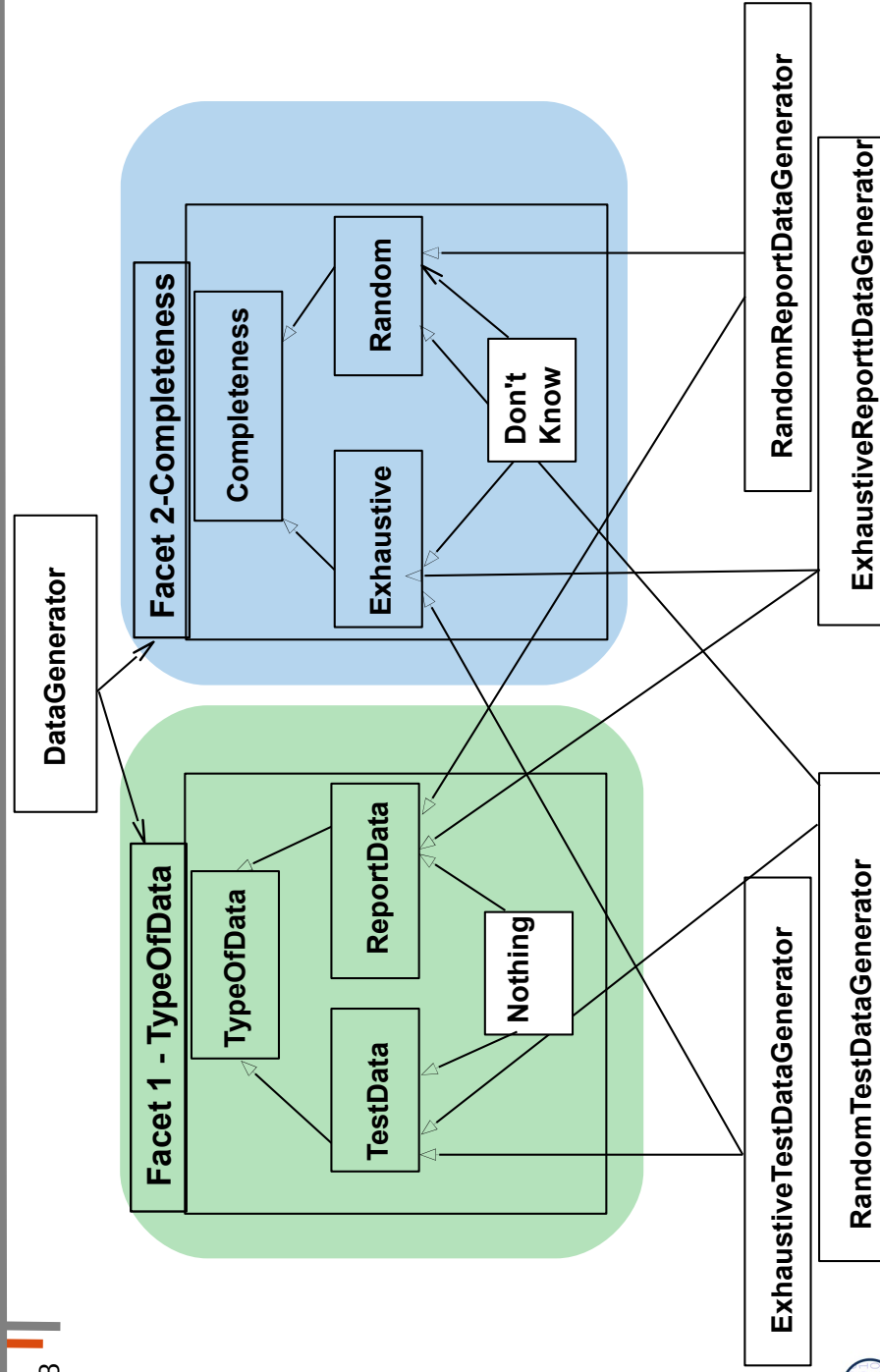

Facets in Living Beings

- ▶ The following model of Living Beings has 3 facets
 - Domain (where does an animal live?); Age; Group of Animal
 - All other classes are abstract
- ▶ Final, concrete classes inherit from all facets.
- ▶ Facets Factorize Models: A full model would multiply all classes (3^n)

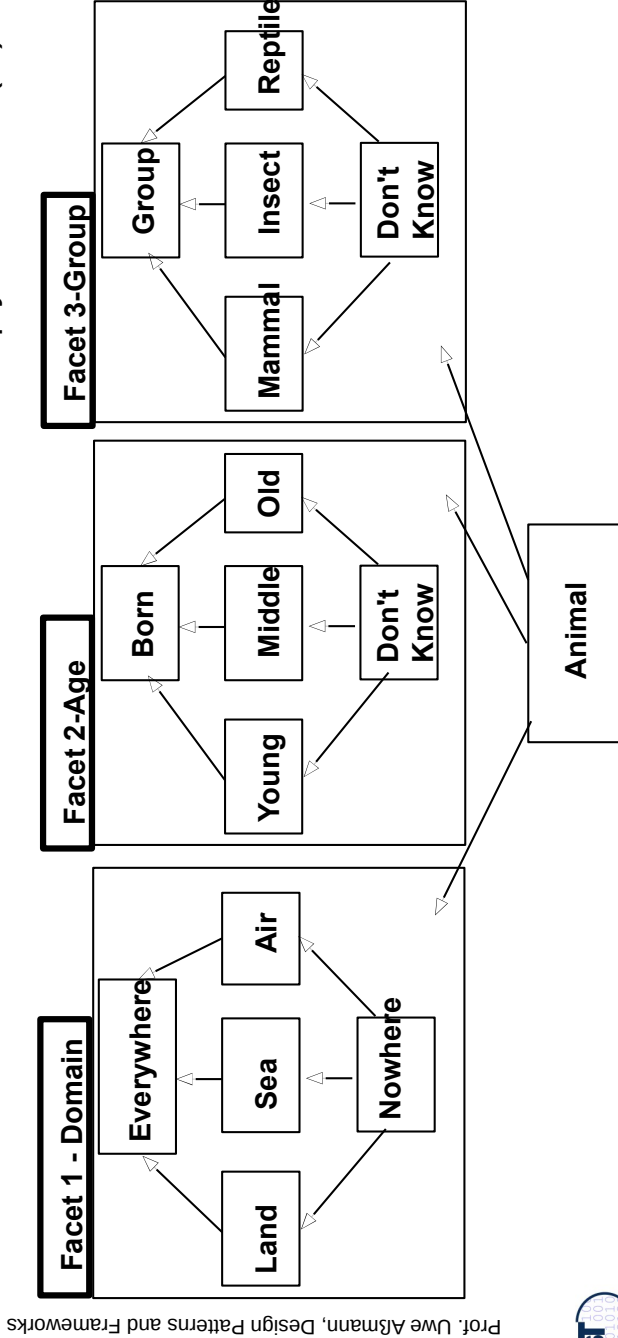

Facets Can Be Implemented by Multi-Bridges

- ▶ One central facet (abstraction), others are delegates in bridges (implementation, group, nature, etc.)
- ▶ Advantage
 - All facets can be varied independently
 - Simple models
- ▶ Restriction: facets model only one logical object
 - With several physical objects

Multi-Bridge with Core Facet

- ▶ Animal as core facet, all others are *hook classes*

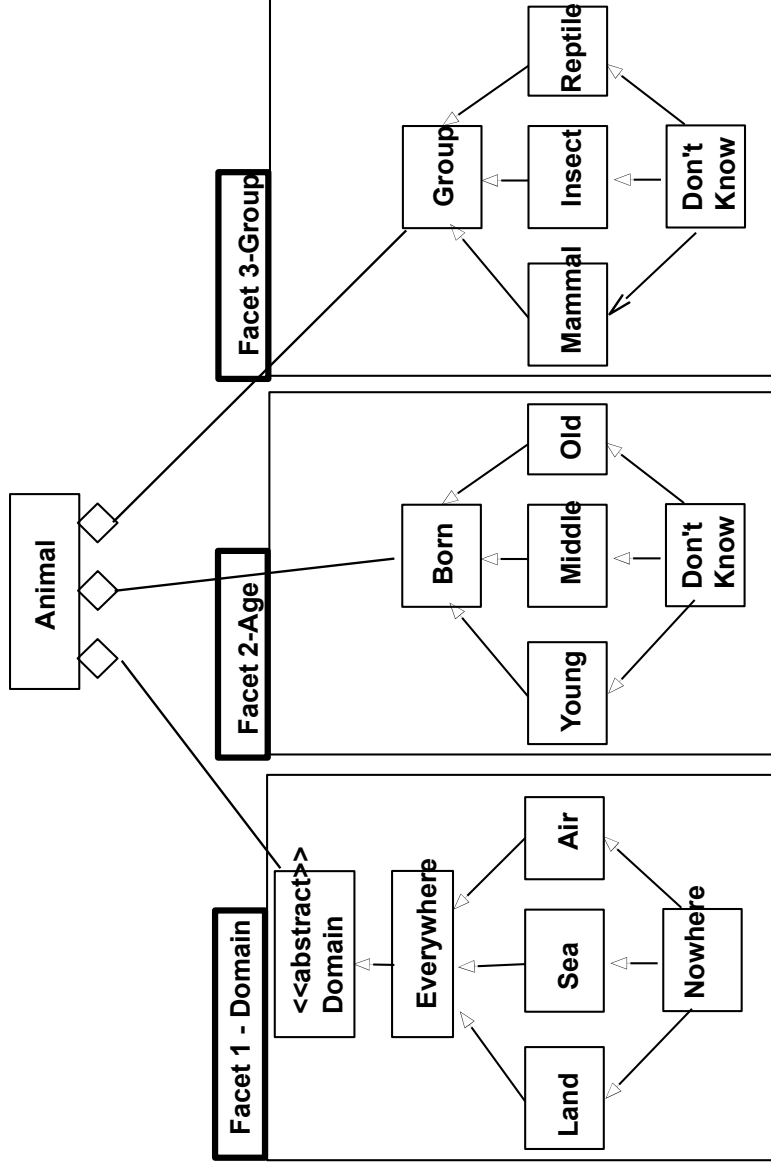

61



Multiple Bridge Without Core

- ▶ Select a primary facet, relate others by bridges (n-Bridge)
- ▶ Problem: primary facet *knows* the others

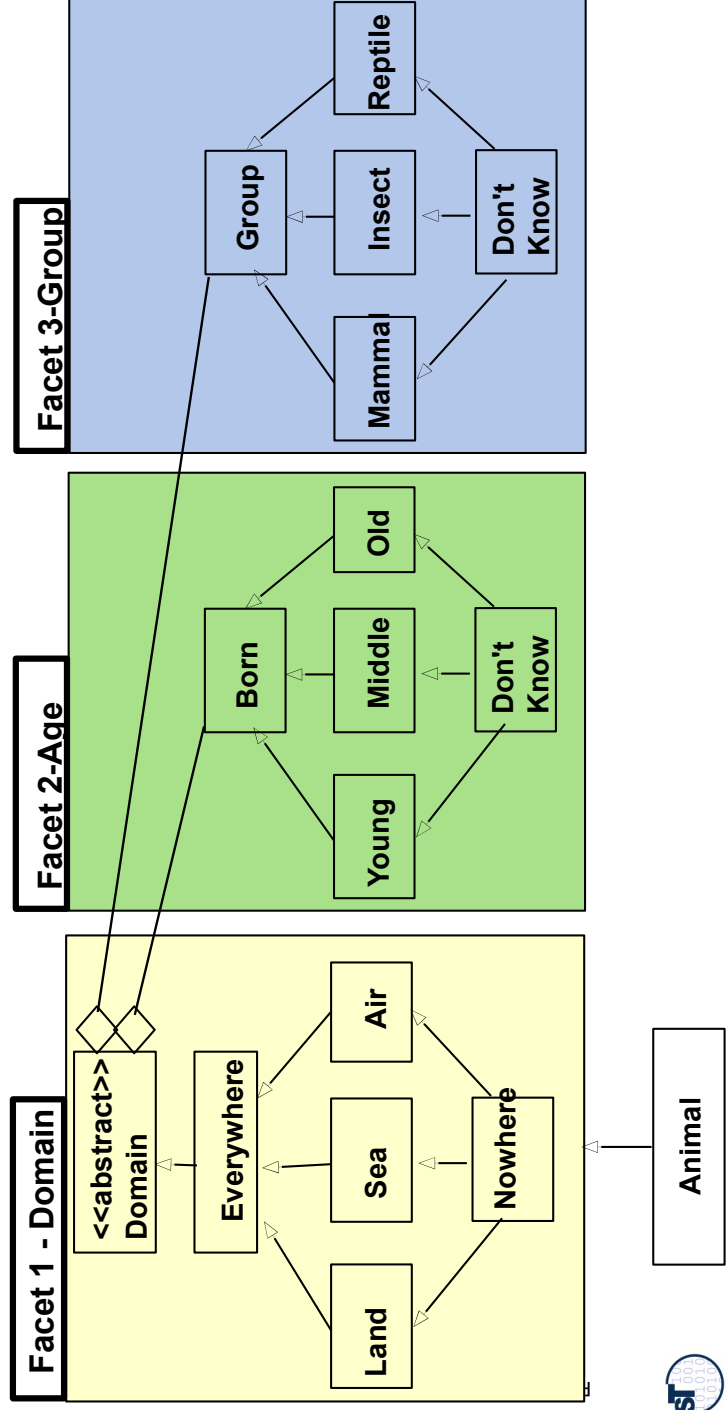

62



How Can I Recognize Facets in Modelling?

- ▶ If a class has several different partitions, this indicates a facet model
- ▶ A model is *not* a facet model, if some class exists, whose heirs *do not partition* the class (non-partitioned inheritance)

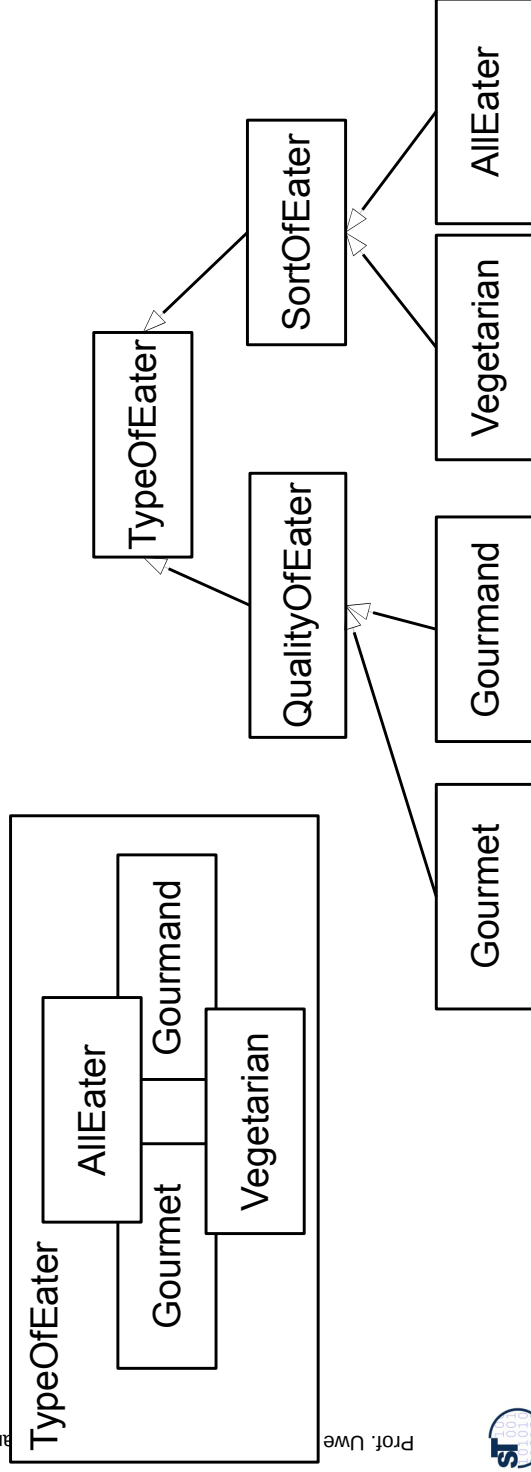

Resolve with Dimensional Class Hierarchies (Bridge)

- ▶ Simple Bridge

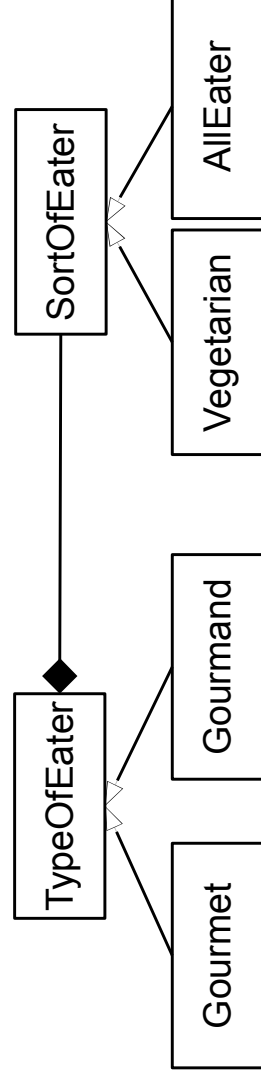

Comparison Facet Bridges with Facet Inheritance

65

- ▶ Advantages:
 - Dynamic variations possible
 - Fewer classes
- ▶ Disadvantages:
 - No type check on product classes
 - No control over which combinations are created (illegal ones or undefined ones)
 - Object schizophrenia
 - Memory consumption with allocations
 - Speed
 - --> not for embedded systems!



Example: Classification of Research Papers after Shaw

99

- ▶ How to classify a research paper?
- ▶ When is it bad, when is it good?
- ▶ Mary Shaw proposed a facet-based classification with the facets
 - Research question
 - Result
 - Evaluation



Classification of Research Papers

67

- ▶ 5+7+5 facet classes → 175 product classes (types of research papers)

Question	Result	Validation
Development method	Process	Analysis
Analysis method	Descriptive model	Experience
Evaluate instance	Analytic model	Example
Generalization	Empirical model	Evaluation
Feasibility	Tool	Persuasion
	Specific solution	
	Report	



68

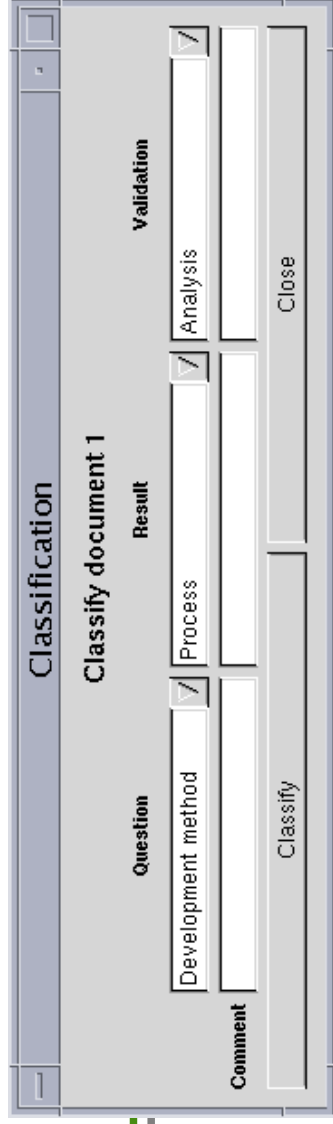

Result					
Classified documents					
Question\Validation	Analysis	Experience	Example	Evaluation	Persuasion
Development method	1		9		
Analysis method	2				
Evaluate instance		3	4	5	10
Generalization				6	7
Feasibility					8

Grouping: Question\Validation Close Regroup

When to Use Facet-based Models

- ▶ When the model consists of independent dimensions
- ▶ When the model is very complicated
- ▶ Realizations:
 - Use multiple inheritance, when good type checking is advantageous (e.g., in frameworks)
 - Use Bridge if language does not support multiple inheritance

Several Nested Facet Groups are Possible

71

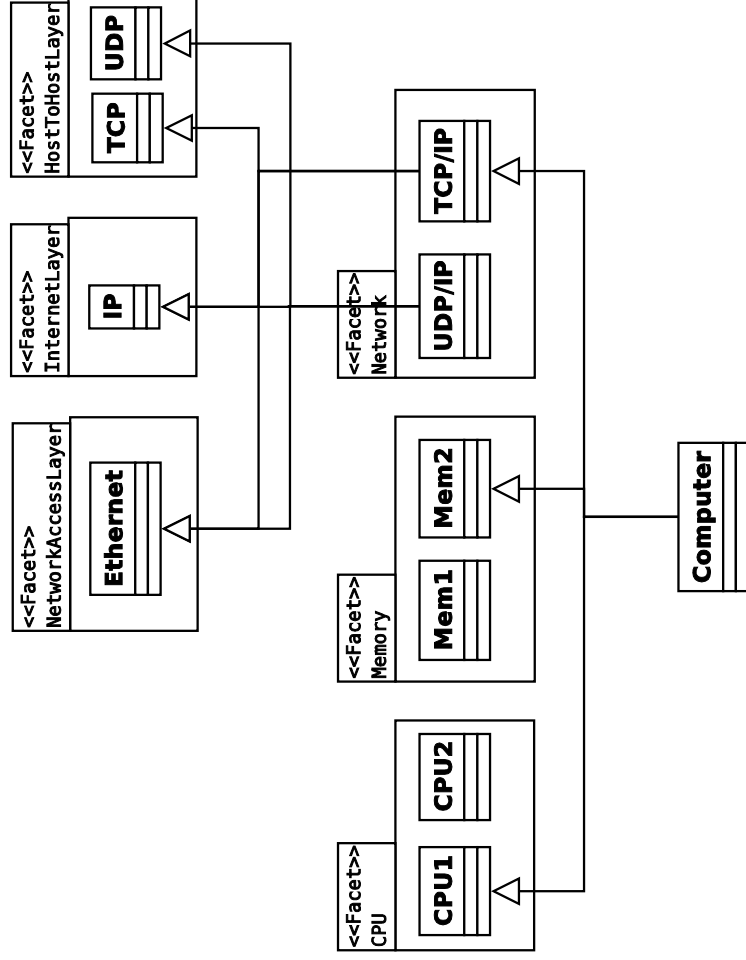

2.3) Layered Objects

72



Be Aware

- ▶ If you meet a Bridge, you may have a facet classification
- ▶ Only question: are the dimensions independent?
- ▶ Sometimes, dependencies exist, e.g., one "dimension" calls another
 - This requires an interface (contract) between the dimensions
- ▶ Then, we have layers

73

Layered Objects with Chain-Bridge

- ▶ Chain Bridge with Core

74

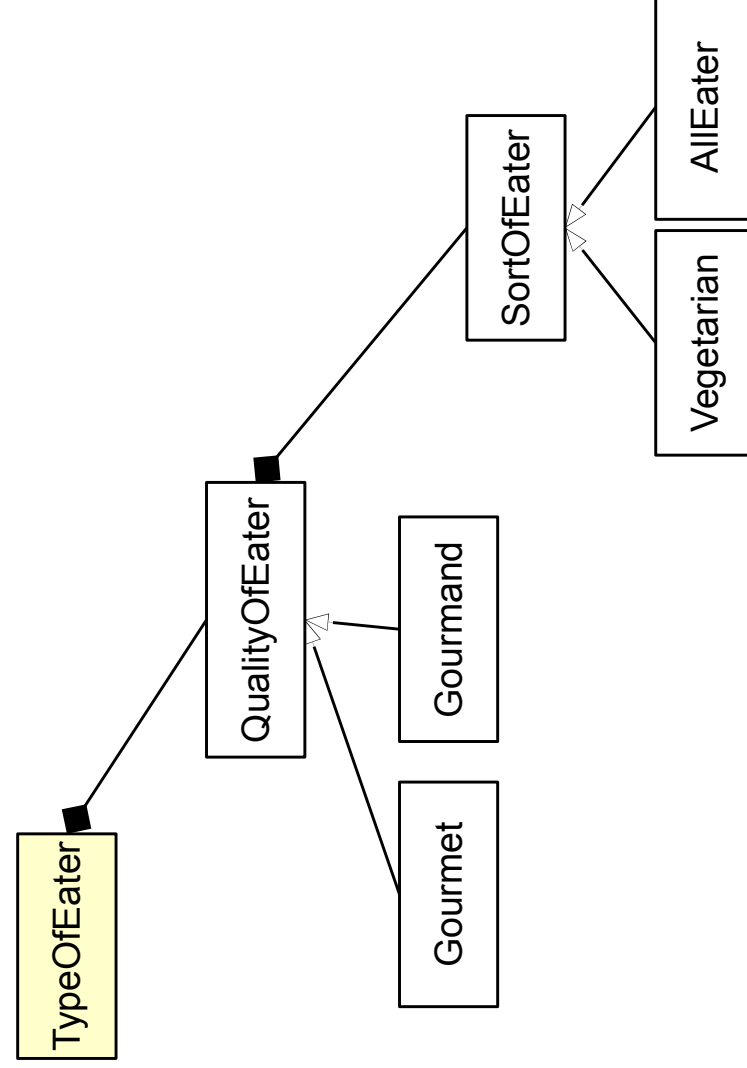

Chain-Bridge for Layered Object Implementation

- ▶ Select a primary facet, relate others by chain-Bridges
- ▶ Here without core

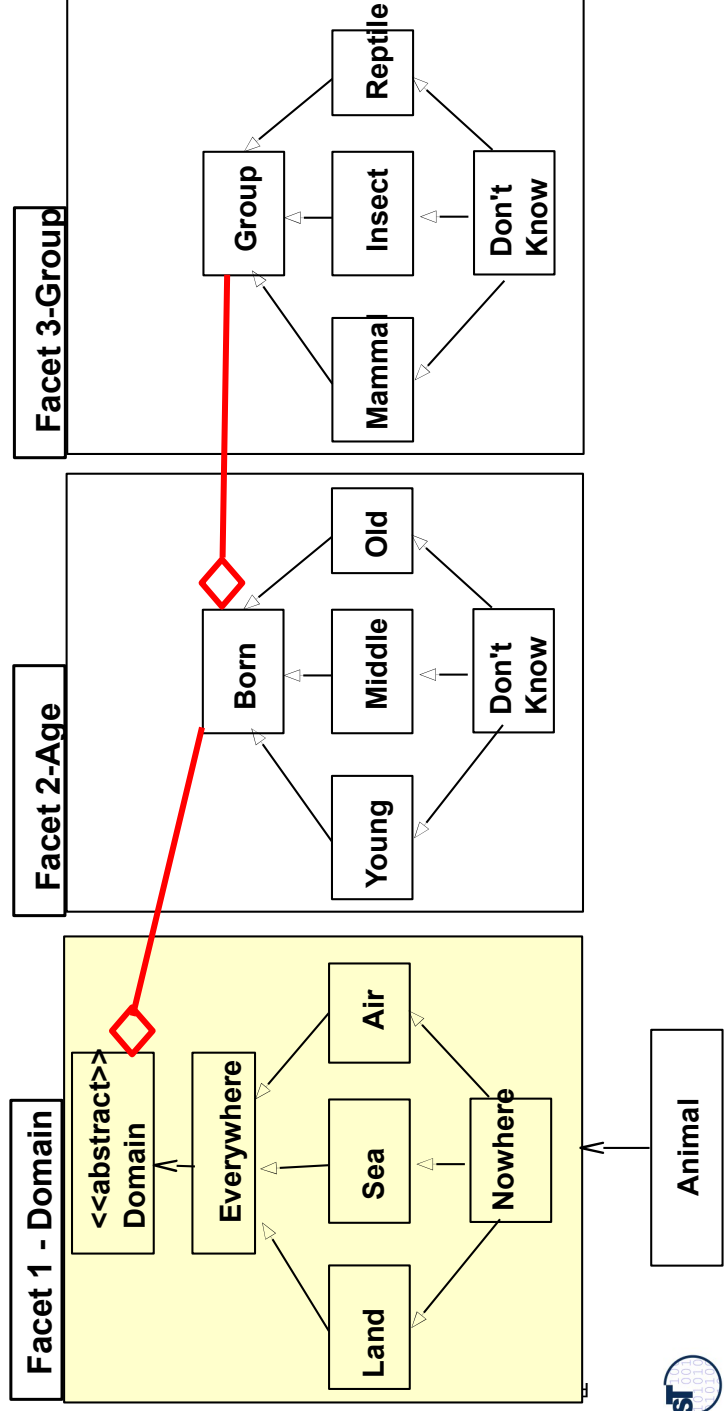

75



Layered Objects

- ▶ Upper layers depend on information of lower layers

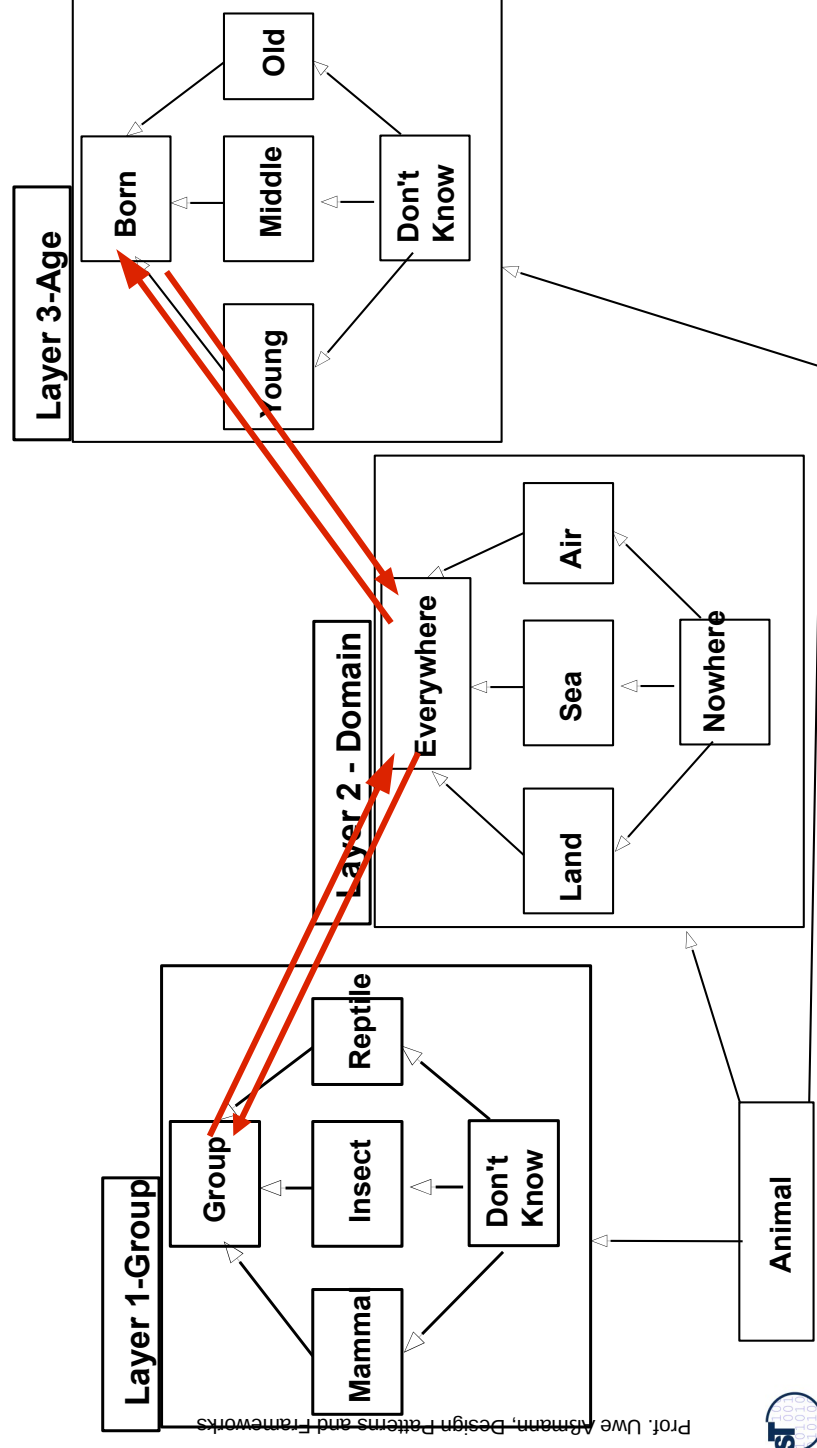

76



Compare to Facets

Dimensions do not depend on information of others

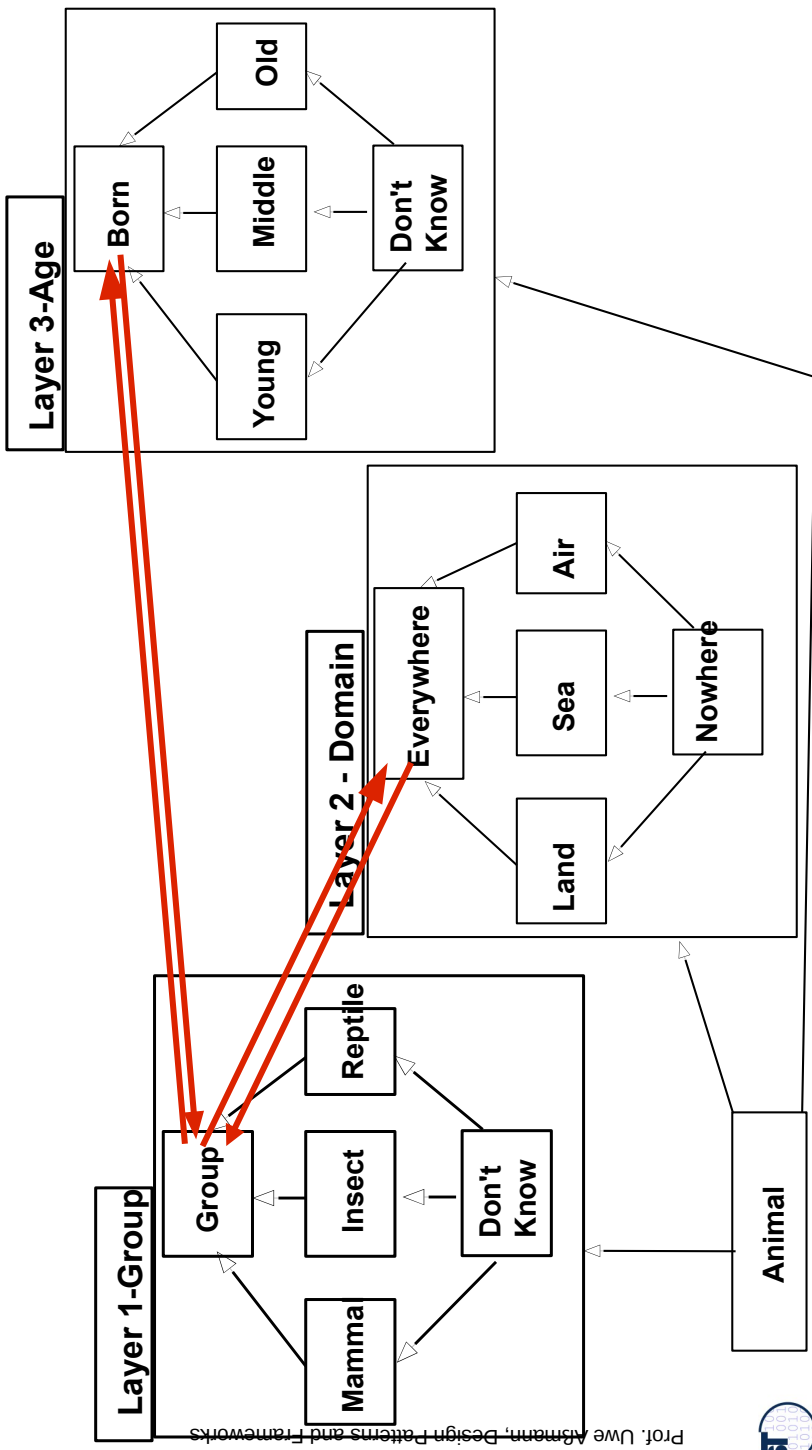

DataGenerator as 2-Chain-Bridge

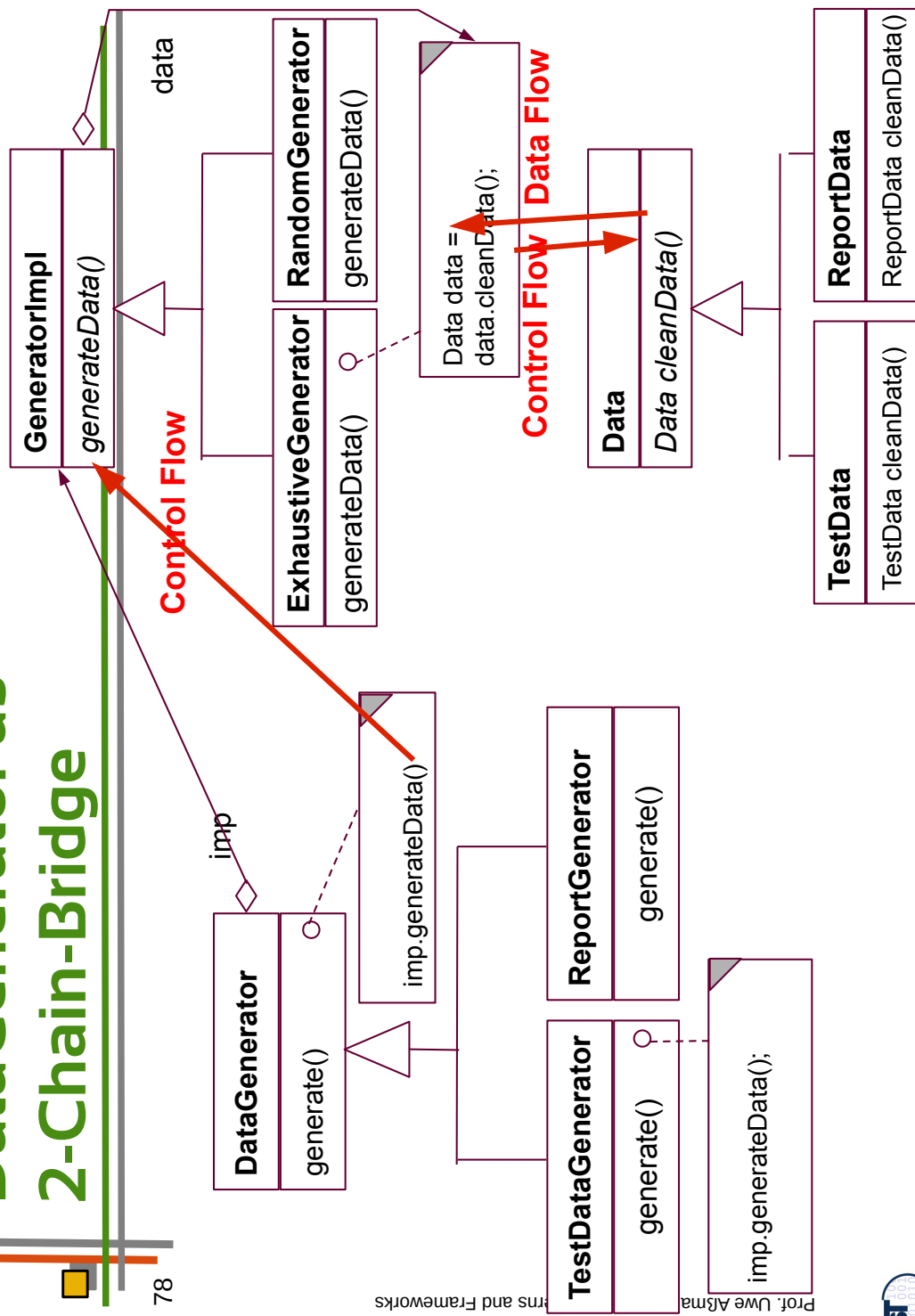

Compare to DataGenerator as 2-Bridge (Facets)

79

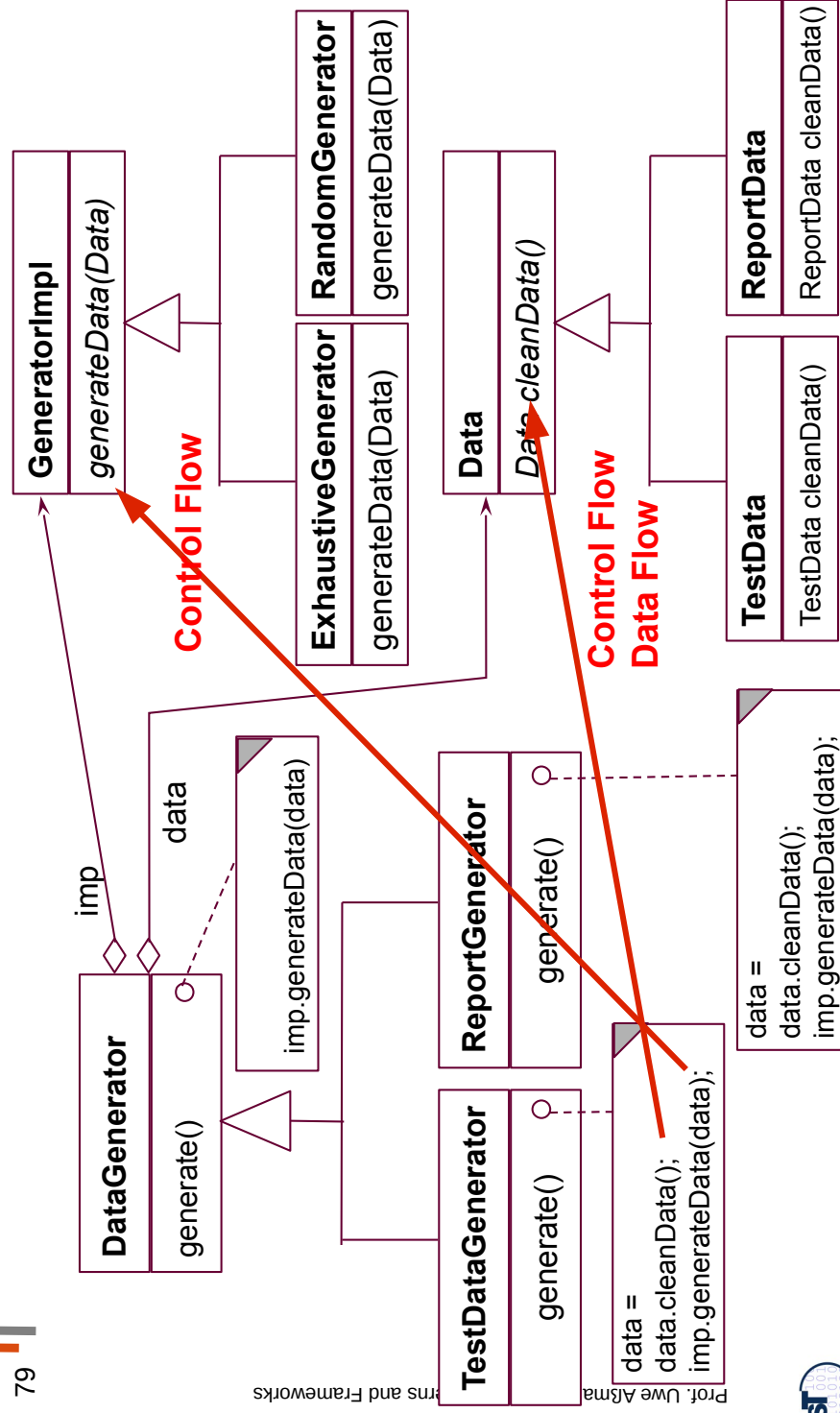

Layered Object Spaces

80

- ▶ A **layered object space** is an object modeled in layers.
- ▶ It is similar to a facet space, however, layers exchange information in a *directed way*
 - Upper layers *call* lower layers, which *deliver* information to upper layers
 - This requires that the abstract topmost classes in a layer provide abstract methods that can be called from other layers
 - The dependencies are *directed and acyclic* (form a DAG)
- ▶ Still, all classes in a layer can be exchanged freely for another
- ▶ Layered object spaces are much broader applicable than facet spaces



2.4) Facet-Bridge Frameworks and Dimensional Systems

18



Multiple Bridges for Facet-Based Systems

28

- ▶ So far, we looked at implementations of faceted or layered objects, i.e., models of complex objects
- ▶ Facet classifications and layered objects can be generalized to facet-based or dimensional *frameworks* and *systems*



Facet-Bridge Dimensional Systems

- ▶ Bridge patterns can be divided upon different dimensions
- ▶ Here: a triple Bridge with core and 3 dimensions, all independent

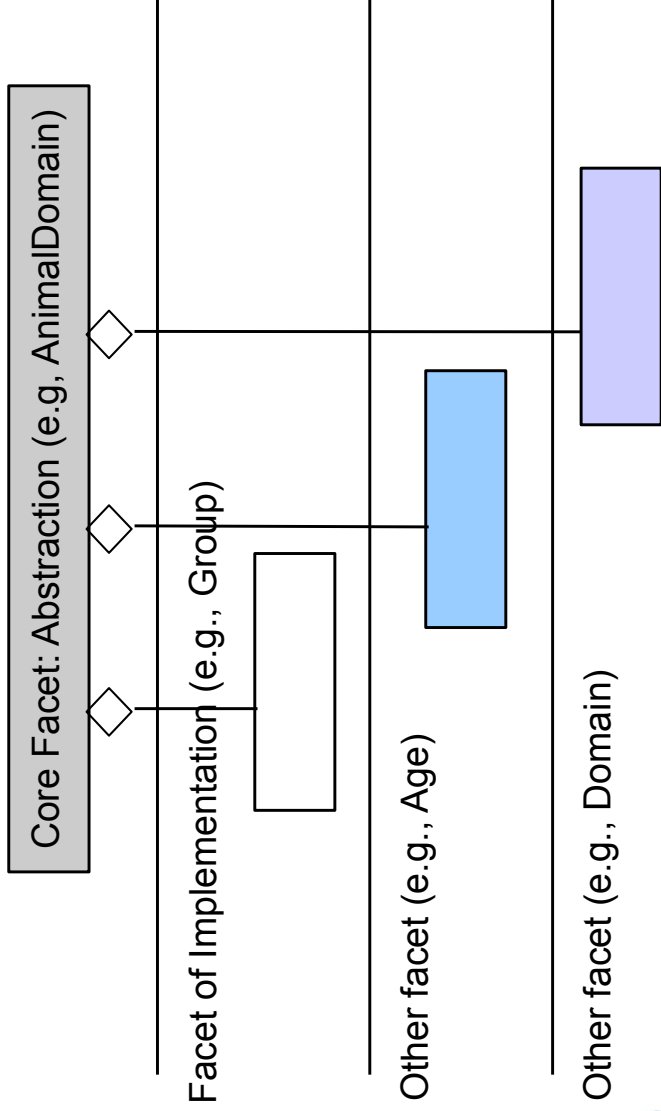

83



Facet-Bridge Frameworks for Facet-Based Systems

- ▶ If one or several layers are fixed, and the rest is variable, *facet frameworks* result

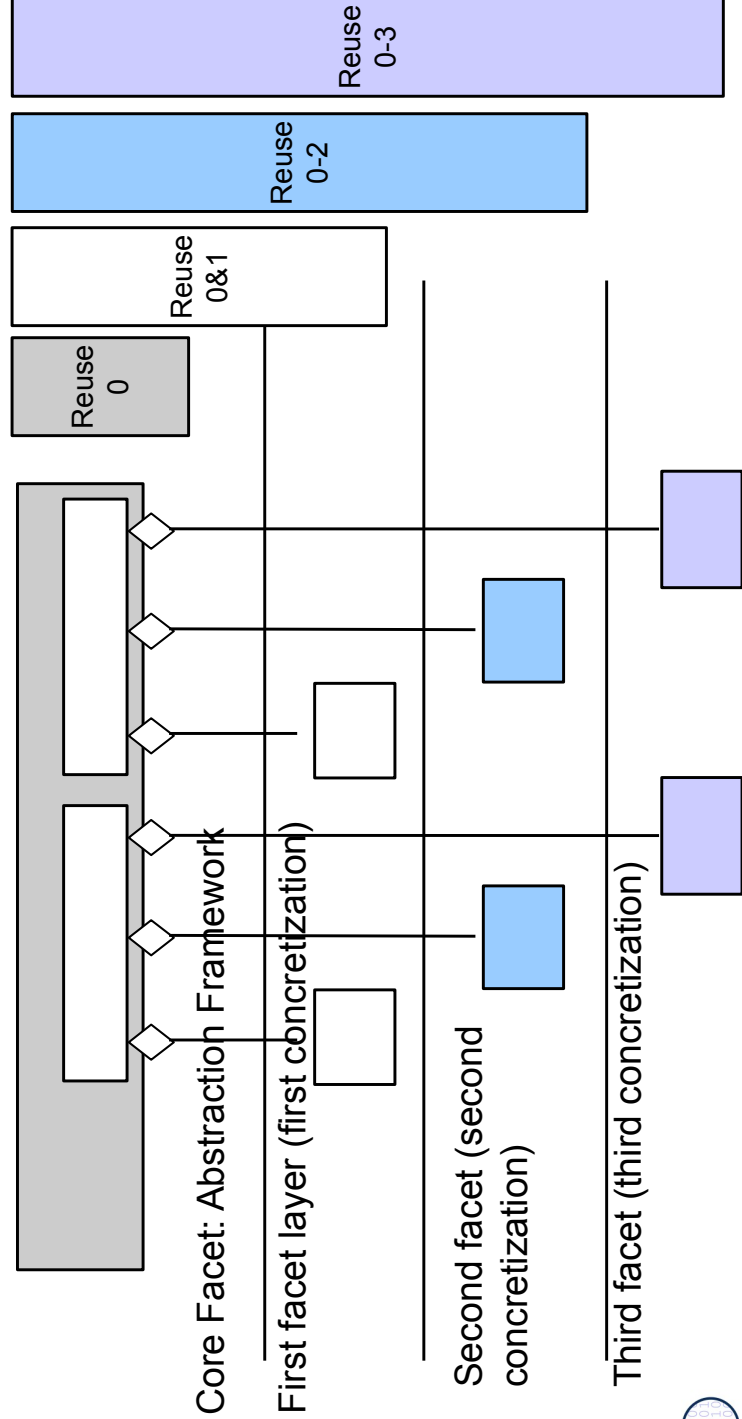

84



Facet-Bridge Frameworks for Facet-Based Systems

OldL and MammalVegetarian

- ▶ Products can be instantiated on every level
- ▶ Every dimension provides additional reuse

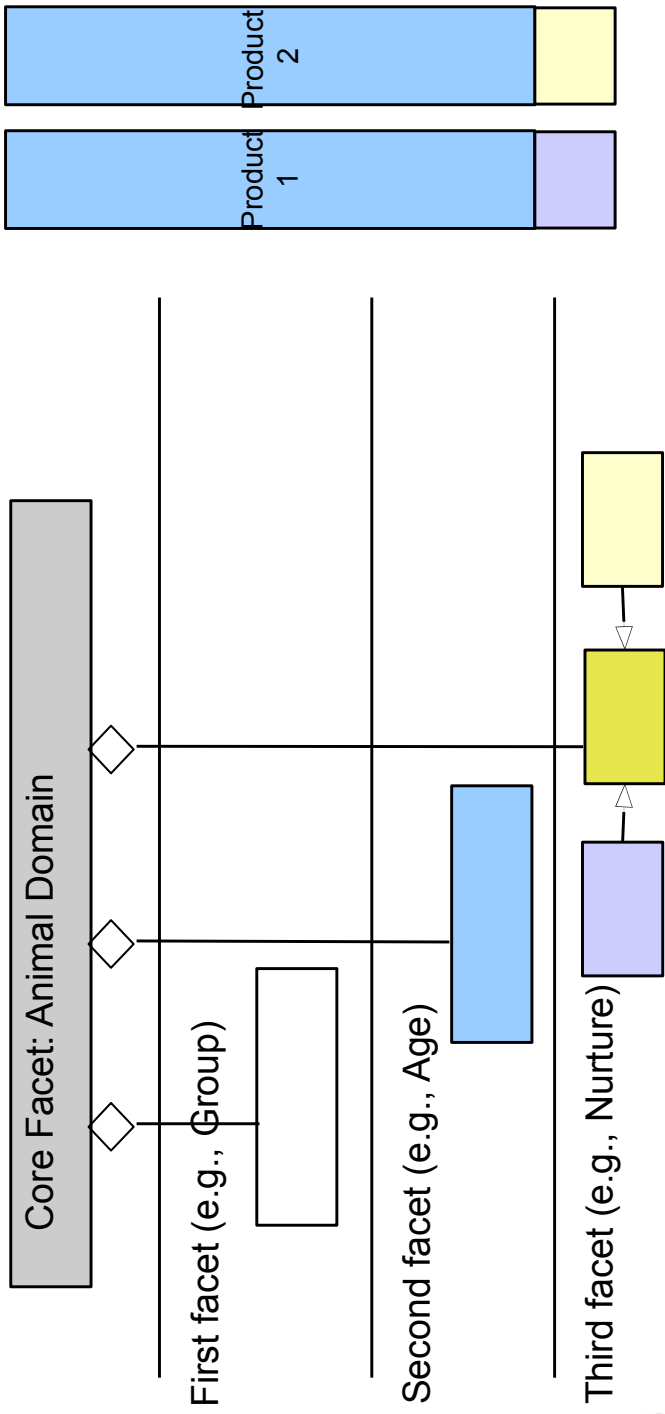

85



Facet-Bridge Frameworks for Business Software

BillForCompanyOfIndustry_in

- ▶ SAP, Peoplesoft, Intentia, IFS

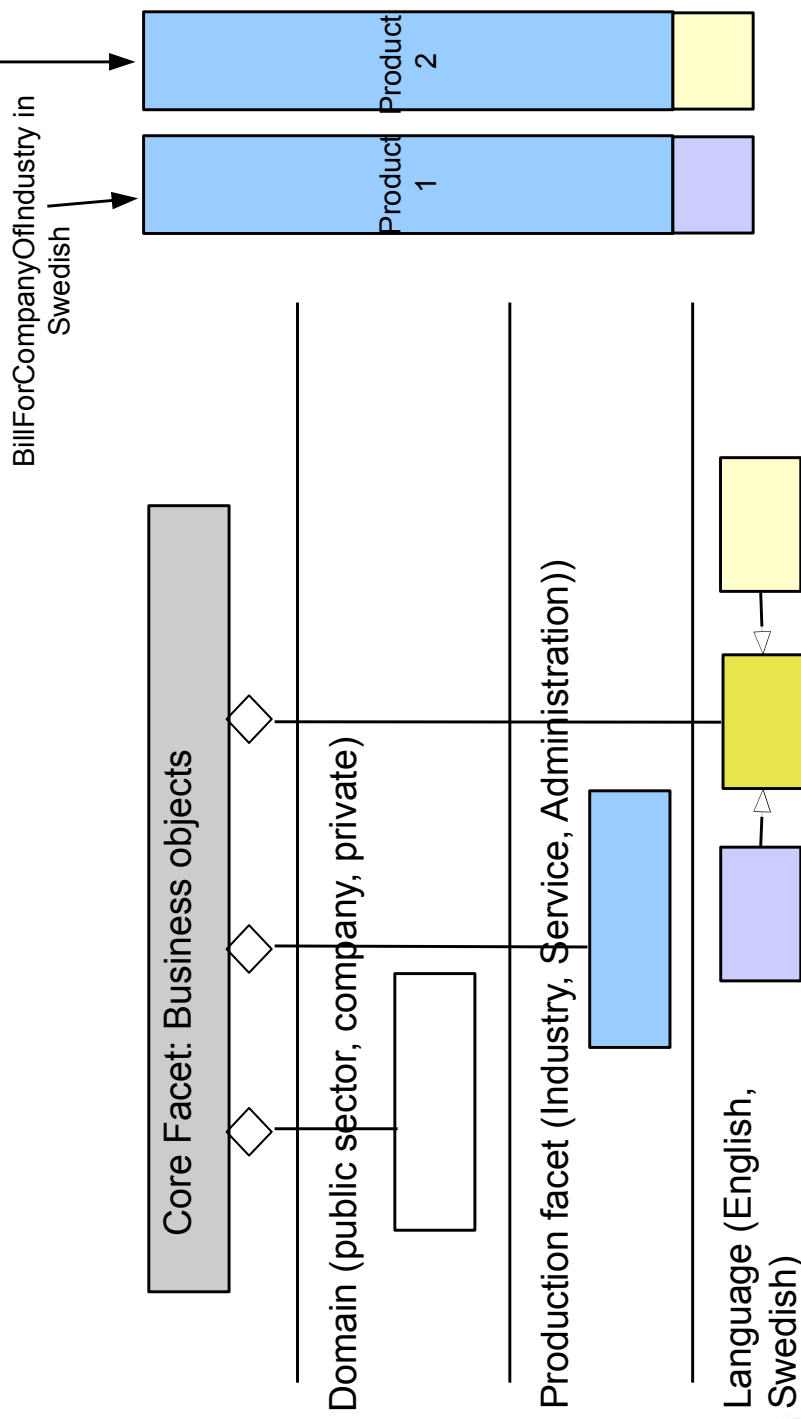

86



Facet-Bridge Frameworks for Component Composition

- ▶ COMPOST (www.the-compost-system.org) is a framework for constructing component systems (a framework for frameworks)

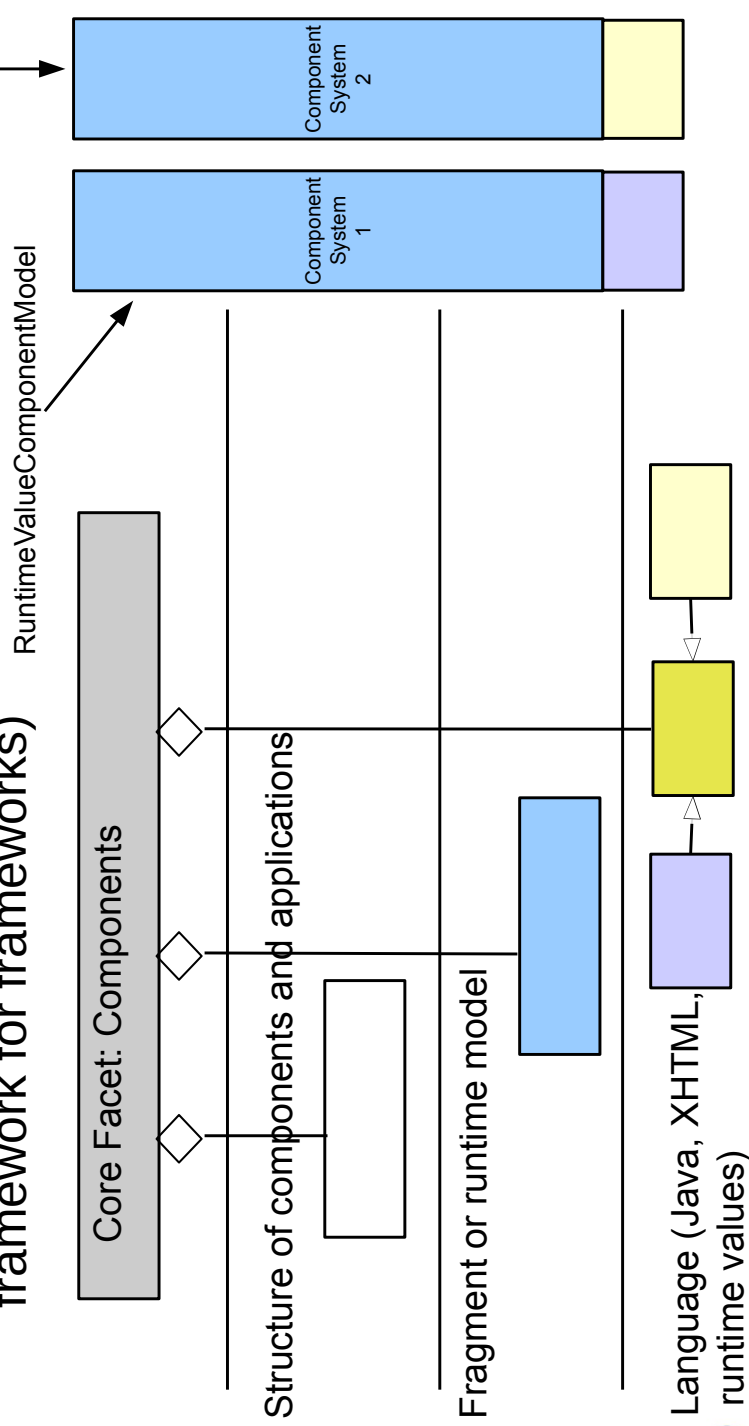

Bridge and Visitor Frameworks for Dimensional Systems

- ▶ Some layers of a dimensional frameworks can be visitors

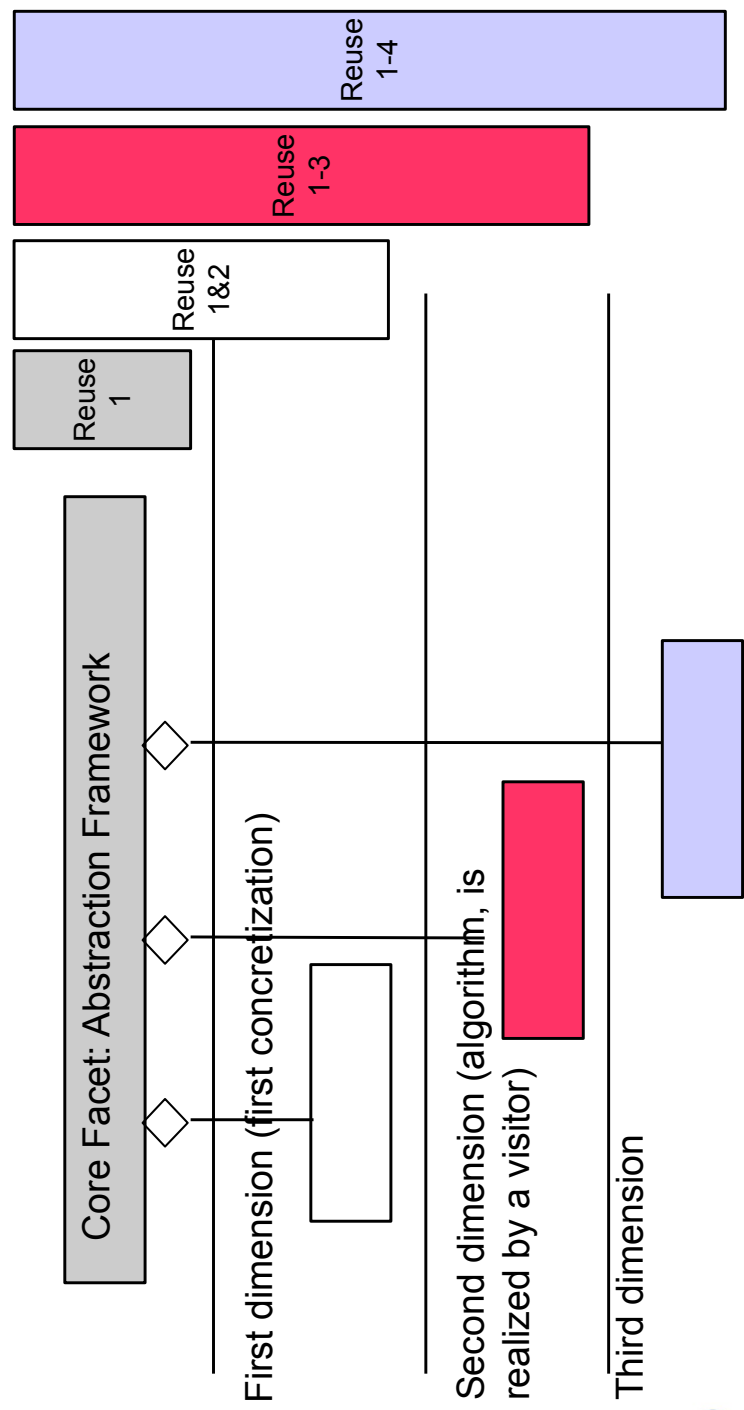

- ▶ Best practice: whenever you have a huge class hierarchy, that is not completely based on partitioning
 - Find out the facets
 - Factor the inheritance hierarchy into the facets
 - Choose a core facet
 - And implement the facets with a facet framework with Bridges.
 - For an n-dimensional facet problem you need at least n-1 Bridges
- ▶ If the “facets” are not independent, introduce layers
 - And implement them with Chain-Bridges

2.5) Layered Frameworks and Systems with Chain Bridges

Layered Frameworks for Layered Systems

16

- ▶ Whenever a system is a layered architecture (stack architecture), a *layered (object) framework* can be used
 - And Chain-Bridges can implement them if the layers are independent of each other (*layered chain-bridge framework*)
 - The layering is an abstraction layering: more detailed things appear as lower layer
- ▶ Modelling criterion: every class must contribute to every layer of a layered object system
 - Classes *crosscut the layers*
 - In general, layered system do not meet this criterion
- ▶ Different products can be configured easily by varying the dimensions of the bridge

Prof. Uwe Almann, Design Patterns and Frameworks



Network Stacks as Layered Bridge System

26

- ▶ ISO/OSI has 7 layers (leads to a 7-Bridge)
- ▶ Every layer knows the next underlying
- ▶ All partial objects call partial objects in lower layers

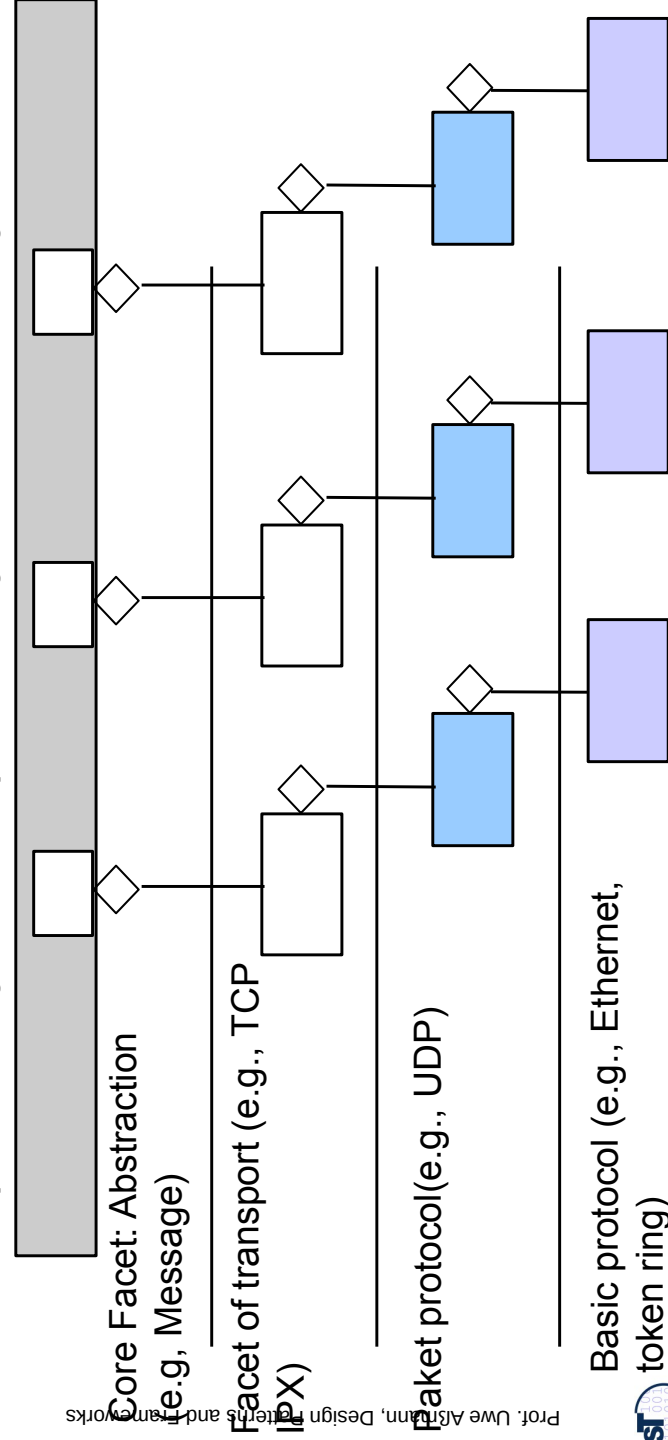

Prof. Uwe Almann, Design Patterns and Frameworks



Databases and Layered Bridge Frameworks

Frameworks

93

- ▶ An object-oriented database, which should be integrated into an application, should be a layered bridge framework

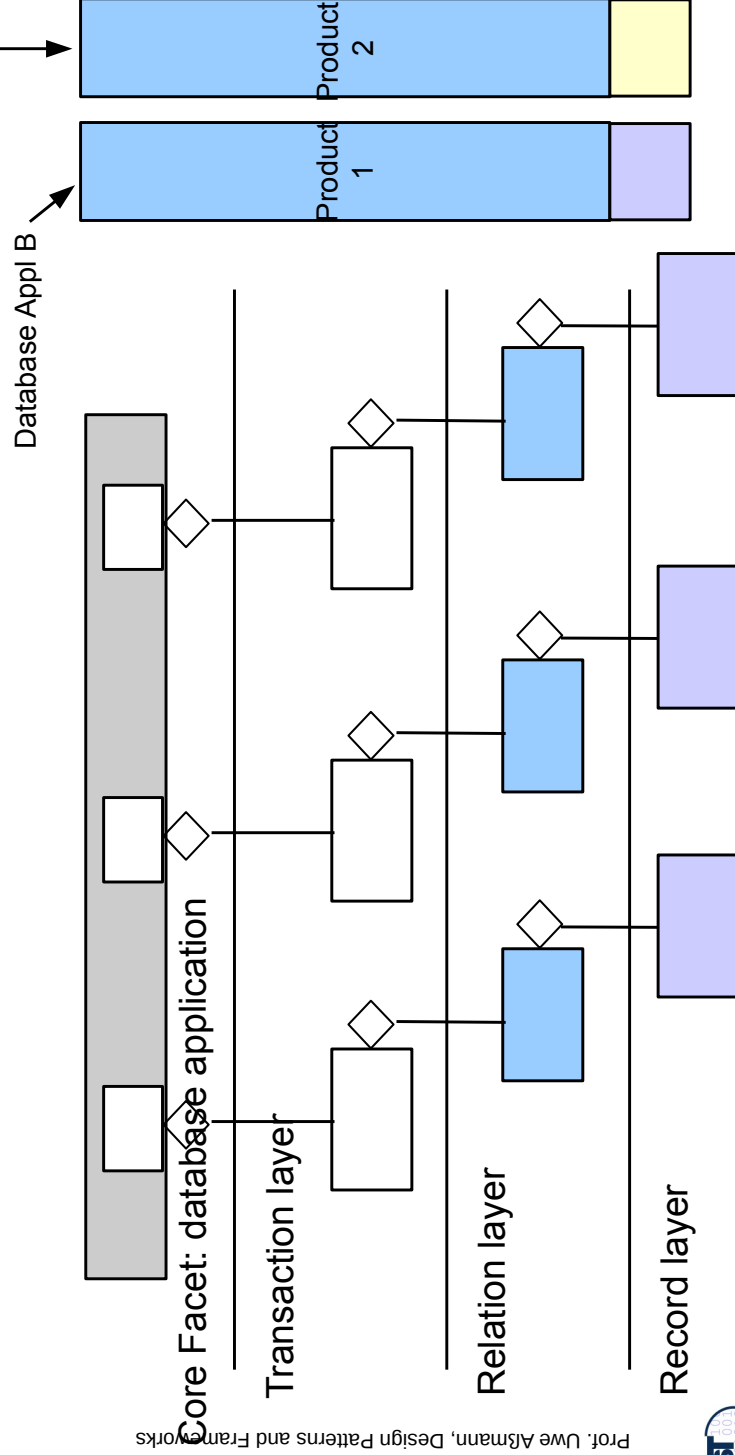

Prof. Uwe Almann, Design Patterns and Frameworks

94



The Role of Layered Frameworks

94

- ▶ Layered frameworks are a very important structuring method for large systems that must be parameterized, varied and extended
- ▶ On every layer, reuse is possible
 - Enormous variability
- ▶ Every layer corresponds to an *aspect* of the application
 - All layers form *stacked aspects*
- ▶ A large system must be *reducible* or *layered*
 - Hence, layered frameworks provide a wonderful, very general methods for product lines of very large products
 - And additionally, for *extensible* systems

Prof. Uwe Almann, Design Patterns and Frameworks

95



The Role of Layered Frameworks

- ▶ At the moment, there are three competing implementation technologies for them:
 - Aspect-oriented weaving
 - View-based weaving (hyperslice programming) [see Component-Based Software Engineering, summer semester]
 - Hand programming
 - Chain-Bridges
 - Role Object Pattern (see later)
- ▶ To me, it looks like layered frameworks are one of *the most important* software engineering concepts of the future

95



The End

96

